

60c ■ JAN. 1967

# Radio-<sup>IND</sup>Electronics

TELEVISION • SERVICING • HIGH FIDELITY

HUGO GERNSBACK, Editor-in-chief

A  
GERNSBACK  
PUBLICATION



4<sup>th</sup> annual

# color-tv issue

WITH DIRECTORY OF 1967 COLOR CIRCUITS

**EASY COLOR SERVICING WITH A TRIGGERED SCOPE**

**3-D COLOR TV BY HOLOGRAPHY?**

**PURITY AND CONVERGENCE INTERACTION**

If you think  
all replacement tubes are alike,  
you've got a surprise coming

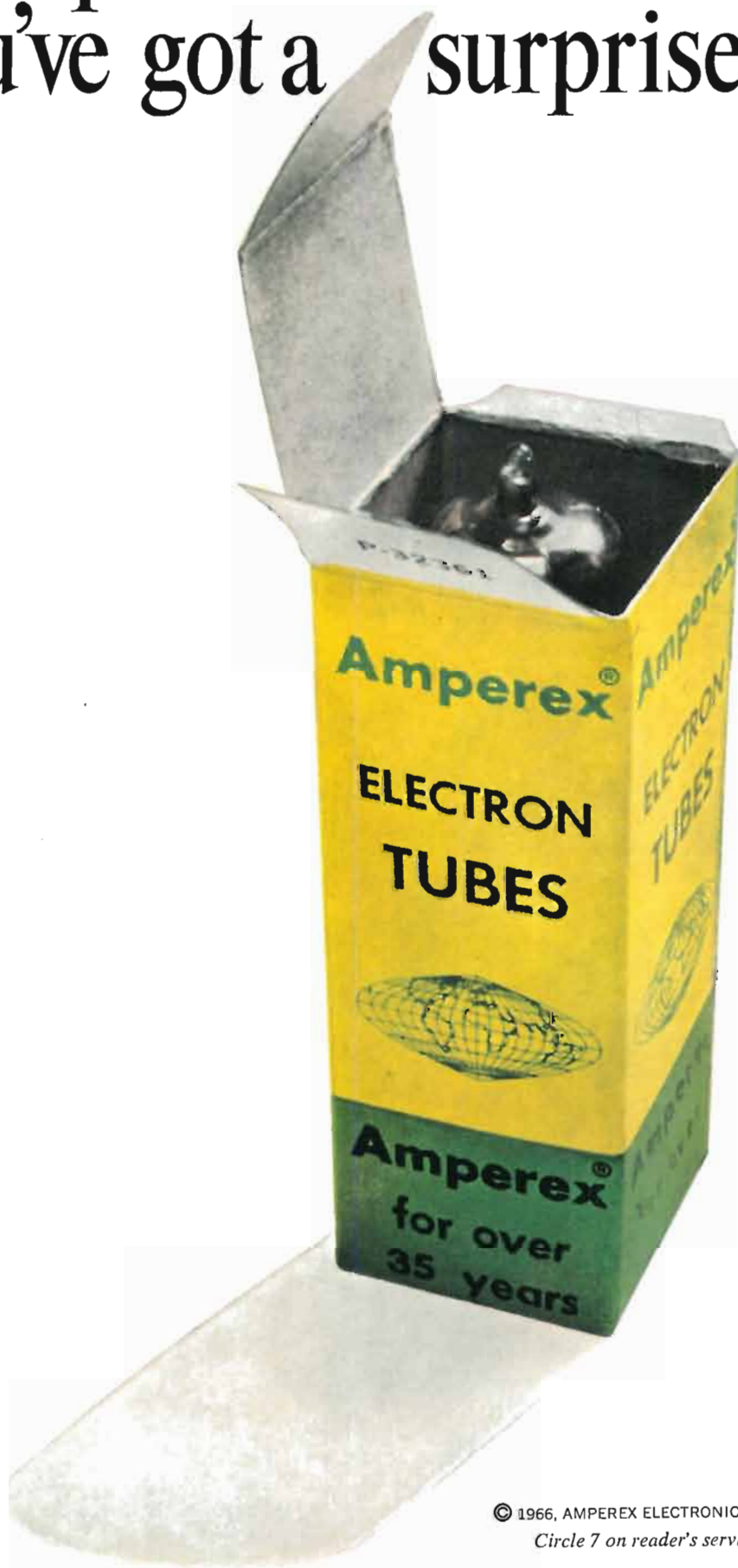



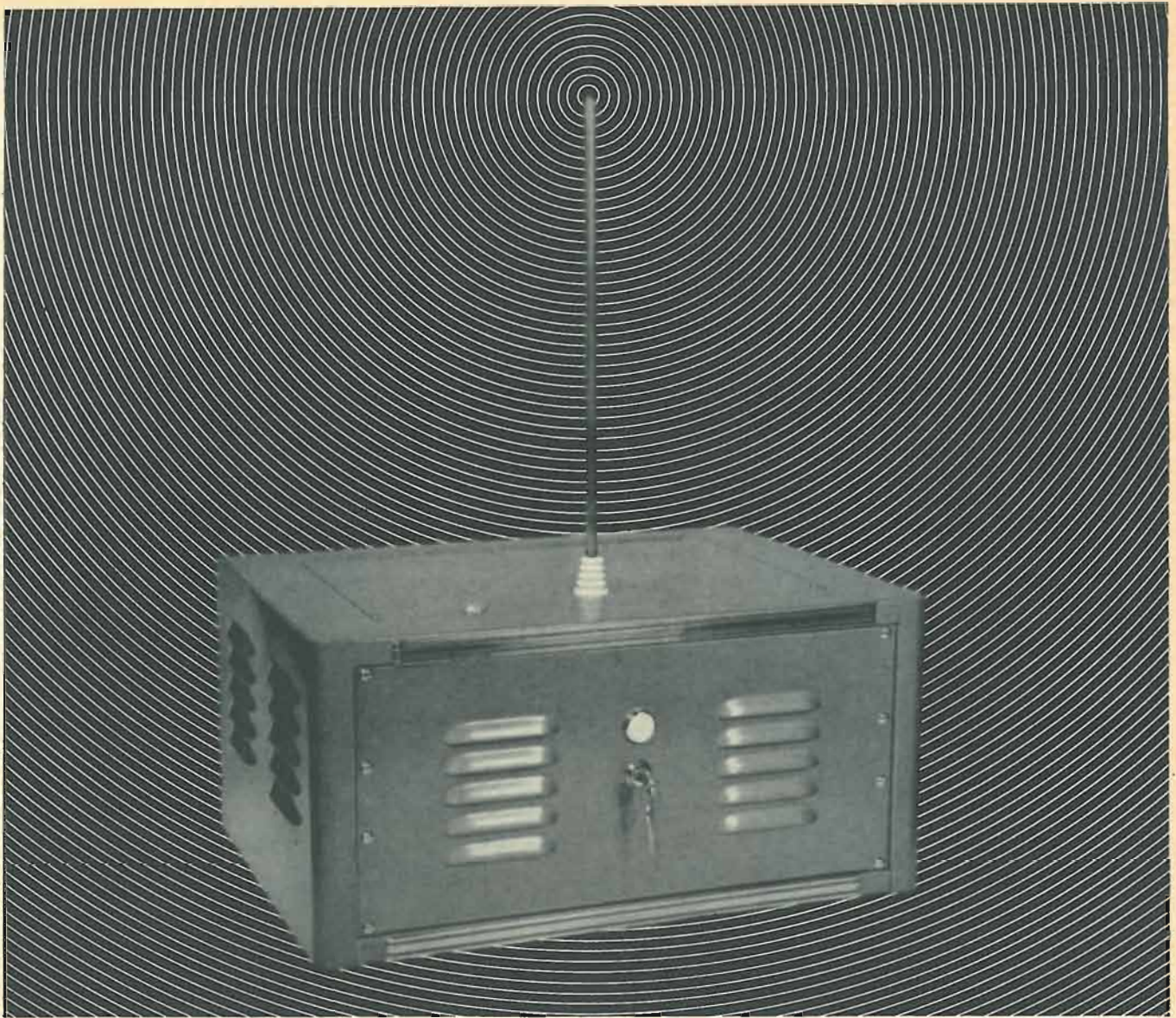

## You are now in Radar Sentry Alarm's r.f. microwave field. Don't move a muscle!

This security system is so sensitive, it can be adjusted to detect the motion of your arm turning this page.

And if this Portable Model Unit were within 35 feet of you and you moved... people up to a half-mile away could hear the siren. Plus with optional equipment, it can detect fire... turn on lights... even notify police.

What does a burglar alarm have to do with you?

Just this: Radar Sentry is no ordinary alarm. It is the most modern and effective security system available. And it's also electronic.

That's why we need you. We need Dealers with technical knowledge. For the most successful Dealers for Radar Sentry Alarm are men who know electronics. This is a product that sells itself when demonstrated properly.

It's been proven time after time. In fact, many of the more than one thousand readers of electronics magazines who became Dealers in the past year — sold a system on their *first* demonstration.

And that's why we need men with technical knowledge and experience.

Men like you.

### How about it?

Do you want to start a business of your own... or expand your present business with a product that in 8 years has become the world-wide leader in its field?

Do you want to earn up to \$5,000 a year in your spare time?

Do you want to earn \$20,000 and more full time?

We'll show you how.

O.K., now you can move.

Fill out the coupon and get complete Dealer/Distributor information... free.

Mail to: RADAR DEVICES MANUFACTURING CORP.  
22003 Harper Ave., St. Clair Shores, Michigan 48080



Please tell me how I can have a business of my own distributing Radar Sentry Alarm Systems. I understand there is no obligation.

Name \_\_\_\_\_

Address \_\_\_\_\_

City \_\_\_\_\_ State & Code \_\_\_\_\_



## What Price Color?

**H**ow often do you hear the question: I wonder what it really costs to own a color TV? Do you ever try to answer it? Have you often wondered yourself?

The question is one of today's most common. No more is there the barrier of "few programs." NBC is transmitting 100% of its network shows in color, and CBS and ABC aren't too far behind. Almost 15% of all television sets in use are color. You can hardly find anyone anywhere who isn't vitally interested in or curious about color television.

So, how much *does* it cost? There are two approaches to a valid answer. Let's look at the cold-cash-outlay approach first.

A new color receiver in the 25-inch class, which is becoming a popular size this season, retails for \$500 to \$900, depending on the cabinet and chassis. So, take \$650 as a median price. An antenna, if one is needed, can add \$25-100 to the investment. A typical cost, installed, is \$55.

Then there's maintenance. Service charges vary so widely it's not easy to pin down a "typical" cost. However, there are fixed-cost annual service contracts, payable in advance; we can use one of them for a norm. One company's first-year contract sells for \$47.

Adding up all these costs, you find an average initial investment of \$752. That's the hard-dollar cost of owning a color-TV receiver, including the first year's maintenance. That's the amount a buyer must lay on the line or get from his bank or finance company.

In essence, this cold-cash approach answers the "How much?" question like this: For \$752 you get a brand new, working, wood-and-guts color set, a color-oriented bunch of fancy aluminum called an antenna, and a year's freedom from service-cost worries. Not a very inviting answer, but an answer nevertheless.

Thank goodness there's another approach to the question—one that's both more attractive and more meaningful. This approach demands a little deeper thinking, however.

Start with the cold-cash figure I already gave you: \$752. Consider then the expenses for the next two years, mostly for maintenance. Second- and third-year

service contracts average \$80 a year. Pretend the set will be thrown away after 3 years (it won't, but this way we avoid bothering about trade-in values). Overall cost, then, is \$912 for 3 years. Averaged out, that's \$304 a year, or \$5.85 a week.

For the final answer to the question "What price color?", figure just what you can get for \$5.85. Most families can find at least three good-quality color movies worth watching each week; cost to see— $\$5.85 \div 3 = \$1.95$ . Consider football, baseball, hockey, races, sports of all kinds; any real sports fan can find two or more of these contests any weekend, in color. Cost: \$2.98 apiece. Color TV babysitting, at 2 hours each weekday and 4 hours on Saturday (forget Sunday), would cost 42¢ an hour.

A most interesting point about these color TV benefits is that none of them conflict with each other in time, and therefore they can all be spread over the cost of a single color set. Considering that, if the owner gets no more from his color receiver than these three services, the cost (computed wholly on a time basis) nets out to a startlingly small amount. To watch two movies—say, "Cleopatra" and perhaps "Bridge on the River Kwai"—will cost 38¢ each (with attendance unlimited). Two ball games—maybe Michigan State vs Notre Dame plus the Chicago Bears playing the St. Louis Cardinals—can be seen by as many people as the TV room will hold, for only 75¢ a game. Afternoon babysitting: 25¢ an hour. Throw in a few favorite soap operas, some daily quiz and game shows, an important documentary now and then, and a couple of early morning adult-education courses. You can easily build a case for the best entertainment bargain in any marketplace.

But no one looks at it that way, you protest. Why don't they? Those services are exactly what every color TV dollar is buying. Next time you hear someone ask "What does color TV really cost, now?"—tell them.

*Forest A. Bell*



# Radio-Electronics

January 1967 VOL. XXXVIII No. 1  
Over 55 Years of Electronic Publishing

## EDITORIAL

- 2** What Price Color? ..... Forest H. Belt

## COLOR TELEVISION

- 24** Service Clinic ..... Jack Darr  
*In the Shop . . . With Jack*
- 32** Purity and Convergence Interaction . . . W. D. Murphy & R. L. Carr  
*Don't be confused about these Siamese twins*
- 36** 1967 Color-TV Roundup ..... Wayne Lemons  
*Integrated circuits, tuning indicators, and high-voltage transistors are color innovations this year*
- 41** What Happened at Oslo? ..... Thomas R. Haskett  
*A report on the international conference which discussed color-TV systems*
- 51** Triggered Scope for Color ..... Larry Allen  
*It makes troubleshooting fast and easy*
- 53** Color Voltages Ain't Circular to Me! ..... Stephen Kirk  
*Forget about vectors—here's an easy way to know chroma*
- 56** Exploring the Jungle of Color Troubles ..... Homer L. Davidson  
*A guided tour of burst, chroma, and killer detectors*
- 59** The Development of a Color-TV Signal ..... Milton A. Sizer  
*How the camera makes the picture at the studio*
- 66** Equipment Reports: Sencore CG-10 "Lo-Boy" Color Generator; Heathkit GR-25 Color Receiver
- 76** Don't Neglect Color-TV Linearity ..... Matthew Mandl  
*A tiny bit of extra effort will bring you pleased customers*
- 100** Color-TV Tube Popularity Guide

## TELEVISION

- 94** The Trouble That Couldn't Happen ..... Milton Lowens  
*Try your mind on this TV problem!*

## GENERAL

- 45** What's New
- 46** Direct-View 3-D Images! ..... Allen B. Smith  
*A startling new scientific technique that makes amazingly real-looking pictures*
- 93** R-E Puzzler

## RADIO

- 44** The Professional Touch for CB ..... Jack Darr  
*Service tips for this specialized field*

## THE DEPARTMENTS

- |                          |                                 |
|--------------------------|---------------------------------|
| <b>16</b> Correspondence | <b>102</b> Noteworthy Circuits  |
| <b>103</b> New Books     | <b>97</b> Technotes             |
| <b>89</b> New Literature | <b>98</b> Try This One          |
| <b>83</b> New Products   | <b>61</b> What's Your EQ?       |
| <b>4</b> News Briefs     | <b>99</b> 50 Years Ago          |
|                          | <b>80</b> Reader's Service Page |



**p 36—NEW CIRCUITS**

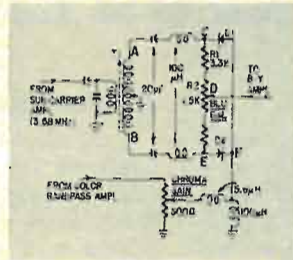

**p 53—CHROMA THEORY**



**p 56—FIX COLOR FAST**

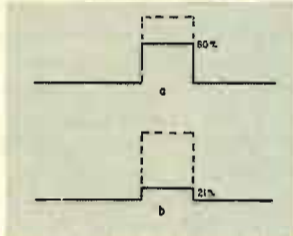

**p 59—GENERATING RGB**



**p 46—LASER PIX**

**p 44—CB TROUBLE HINTS**

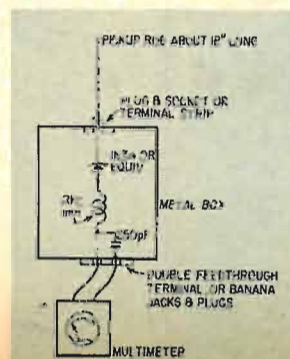

RADIO-ELECTRONICS, JANUARY 1967, Volume XXXVIII, No. 1. Published monthly by Gernsback Publications, Inc., at Ferry St., Concord, N. H. 03302. Editorial, Advertising, and Executive offices: 154 West 14th Street, New York 10011. Circulation Office, Boulder, Colo. 80302.

Second-class postage paid at Concord, N. H. Printed in U.S.A. One-year subscription rate: U. S. and possessions, Canada, \$5. Pan-American countries, \$6. Other countries, \$6.50. Single copies: 60c. © 1966, by Gernsback Publications, Inc. All rights reserved. POSTMASTERS: Notices of undelivered copies (Form 3579) to Boulder, Colo. 80302.

## COLOR SCANNING

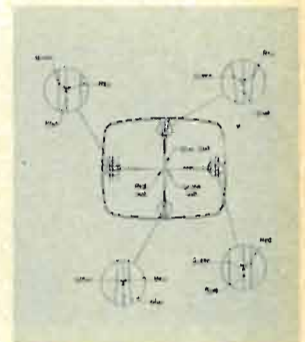

**p 32**—Two separate but related functions affect the image formed by a color CRT. Learn the how's and why's of purity and convergence action.

## SCOPE TECHNIQUE

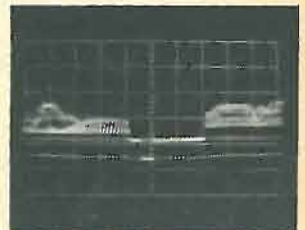

**p 51**—Service is easier when you use a triggered oscilloscope. It's different, and ideal for color.



Member,  
Institute of High Fidelity.  
Radio-Electronics is indexed in  
*Applied Science & Technology Index* (formerly *Industrial Arts Index*)



# NEWS BRIEFS

## VIDEO VISIT FROM VIETNAM

Television tape recordings were used recently to allow three US soldiers in Vietnam to "visit" with their families in Chicago. Low-cost CCTV-type video recorders were used to record the sight-and-sound messages in the battle zone. Then the tapes were flown back to the US and showed to the GIs' relatives. The photo shows a Chicago couple hearing their son.



The system, which was tested for possible regular use, was made possible by Ampex Corp., which donated two recording systems and several hundred reels of tape, and by Capital Cities Broadcasting, which assisted in financing the test. TV executive John Porterfield organized and produced the mission.

## HUGO GERNSBACK HONORED BY WIRELESS PIONEERS

A recent gathering of the Antique Wireless Association, a group of amateur radio historians and collectors, paid tribute to pioneer publisher and radio manufacturer Hugo Gernsback. Among the exhibits of coherers, magnetic and electrolytic detectors, and early microphones, were many pieces of equipment manufactured by the Electro Importing Co., an early Gernsback enterprise. During the luncheon held in his honor, Mr. Gernsback addressed the group by means of a special tape recording. He stressed the need to preserve historical records and artifacts and spoke of his desire to see a museum devoted entirely to communication. Distinguished guests included: Elliott Sivowitch, assistant to curator, and Dr. Bernard Finn, curator of electricity, both of the Smithsonian Institute, and Frank Davis, curator, Ford Science Museum.

## SLOW-MOTION TV REPLAY

Baseball fans saw a further innovation in TV engineering used in last year's World Series. Interesting or tricky visual action was recorded and played back later in slow motion—electronically.

The technique made use of MVR Corp.'s VDR 250 Videodisc slow-motion recorder, which can record video signals on a magnetic disc. When replayed, action may be slowed or stopped completely, or it may be viewed at medium-slow motion as well as at normal speed. After recording, the machine can be cued for replay in less than half a second.

## ELECTRIC-POWERED VEHICLES BEING TESTED

Research continues in attempts to develop a practical electric auto to meet today's needs. General Motors has installed silver-zinc battery packs, SCR's and specially designed ac motors in its experimental Electrovaair II. Performance is reported similar to that of a gasoline-powered Corvaair except for cruising range. The electric car must recharge its batteries every 40 to 80 miles, vs a range of 250-300 miles for gasoline-refill range of a standard car. A regular 1966 Corvaair chassis is used, but Electrovaair II weighs 800 pounds more than its gasoline-powered cousin.

Another experimental vehicle being tested by GM is Electrovan, a van truck using tanks of liquid hydrogen and oxygen as an electric fuel cell. Such a power source is still expensive and not yet practical.

## HELICOPTERS USE NIGHT VIDEO

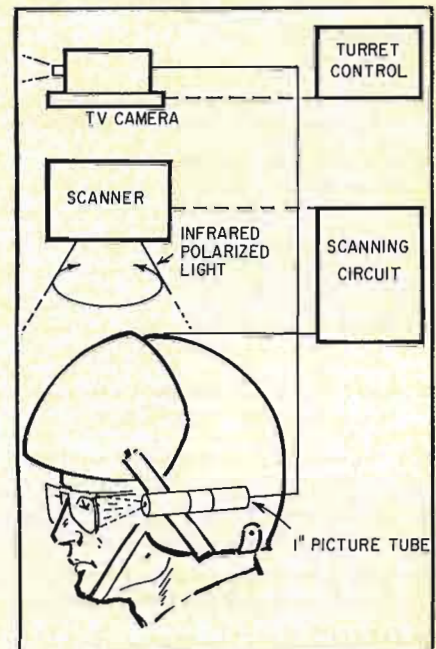

An infrared light source, a TV camera sensitive to infrared, and a special display system are being used by US helicopters in Vietnam. The apparatus enables flight personnel to see terrain in apparently total darkness.

No ordinary TV monitor is used. As the drawing shows, small CRT's are placed on each side of the pilot's head. Tube displays are picked up by glass in spectacles worn by the pilot. Thus he sees a TV picture of ground ahead of and below his plane, as well as being able to see normally through the plain lenses of the glasses.

*continued on page 6*

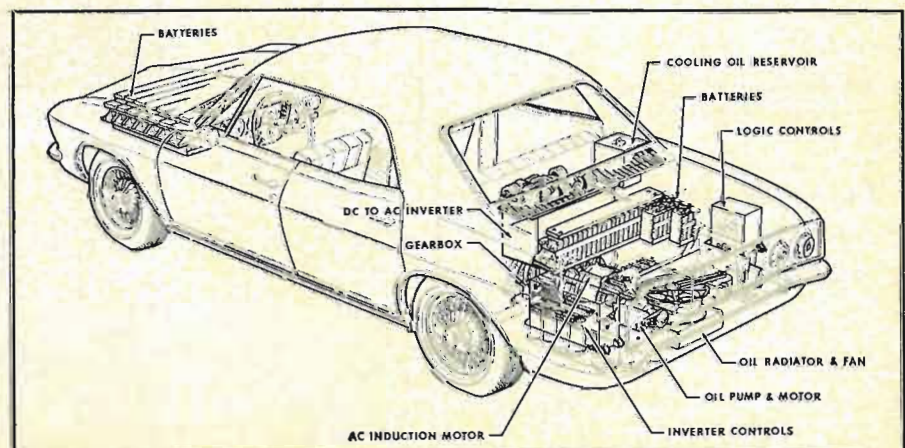



**columbia  
stereo tape club**

now offers you

**any 5  
stereo tapes  
free**

if you begin membership by purchasing just one tape now, and agree to purchase as few as five additional selections in the next 12 months, from the more than 200 to be offered

**JUST LOOK AT THE EXCITING STEREO TAPES** on this page! Which ones would you like to add to your own collection? By joining the Columbia Stereo Tape Club now, you may have ANY FIVE of the magnificently recorded 4-track stereo tapes shown here — sold regularly by the Club for up to \$46.75 — ALL FIVE FREE!

**TO RECEIVE YOUR 5 PRE-RECORDED STEREO TAPES FREE** — simply write in the numbers of the 5 tapes you wish in the coupon at the right. Then choose another tape as your first selection, for which you will be billed \$7.95, plus a small mailing and handling charge. Also be sure to indicate the type of music in which you are mainly interested: Classical or Popular.

**HOW THE CLUB OPERATES:** Each month the Club's staff of music experts chooses a wide variety of outstanding selections. These selections are described in the entertaining and informative Club magazine which you receive free each month.

You may accept the monthly selection for the field of music in which you are primarily interested . . . or take any of the wide variety of other tapes offered by the Club . . . or take NO tape in any particular month.

After purchasing your first tape through this advertisement, your only membership obligation is to purchase 5 additional tapes from the more than 200 to be offered in the coming 12 months. Thereafter, you have no further obligation to buy any additional tapes . . . and you may discontinue your membership at any time.

**FREE TAPES GIVEN REGULARLY.** If you wish to continue as a member after fulfilling your enrollment agreement you will receive — FREE — a 4-track stereo tape of your choice for every two additional tapes you buy from the Club.

The tapes you want are mailed and billed to you at the regular Club price of \$7.95 (occasional Original Cast recordings somewhat higher), plus a small mailing and handling charge.

**SEND NO MONEY** — Just mail the coupon today to receive your six stereo tapes and FREE take-up reel!

**Note:** All tapes offered by the Club must be played back on 4-track stereo equipment.

**COLUMBIA STEREO TAPE CLUB**  
Terre Haute, Indiana

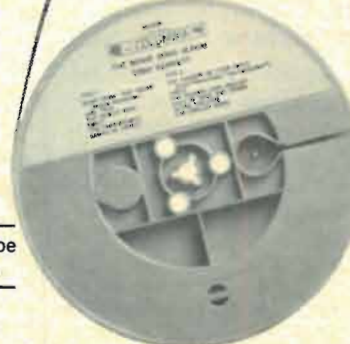

**FRANK SINATRA**  
Strangers in the Night  
Blue — DOWN TOWN  
CALL ME 7 MORE  
COLUMBIA

2673. Also: On A Clear Day, All Or Nothing At All, etc.

Barbra Streisand  
**Color Me Barbra**  
COLUMBIA

2407. Where Am I Going, C'est Se Bon, Yesterdays, etc.

**ROGER WILLIAMS**  
plays THE HITS  
Dear Heart - Mr. Lonely  
People 8 MORE  
KAPP

2077. Also: Willow Weep For Me, Frenesi, Try To Remember, etc.

**Man of La Mancha**  
Starring RICHARD KILEY  
Original Cast  
KAPP

2639. "The best musical score of '65." —Am. Record Guide

**TCHAIKOVSKY:**  
THE NUTCRACKER  
SWAN LAKE (Suites)  
ORMANDY  
PHILADELPHIA ORCHESTRA  
COLUMBIA

2405. "Exciting, sensuous romanticism." —N. Y. Times

With Respect to Nat  
**OSCAR PETERSON**  
TRIO AND ORCHESTRA  
Sweet Lorraine  
Unforgettable 10 MORE  
COLUMBIA

2485. Also: Walkin' My Baby Back Home, Unforgettable, etc.

**PETER PAUL & MARY**  
See What Tomorrow Brings  
• Early Mornin' Rain  
• If I Were Free  
10 MORE  
WARNER BROS.

2225. Also: Jane, Jane; The Rising of The Moon; etc.

**WEST SIDE STORY**  
Original Soundtrack  
COLUMBIA Recording

1037. "The most adventurous musical ever made." —Life

**TWO FAVORITE GUITAR CONCERTOS**  
CASTELNUOVO TEDESCO  
RODRIGO  
JOHN WILLIAMS  
Guitar  
ORMANDY  
PHILADELPHIA ORCHESTRA  
COLUMBIA

2471. "It is a brilliant composition." —St. Louis Globe

**One Stormy Night**  
THE MYSTIC MOODS ORCHESTRA  
PHILIPS

2676. A truly unique listening experience awaits you.

**SEPTEMBER OF MY YEARS**  
**FRANK SINATRA**  
It Was a Very Good Year  
12 MORE  
REPRISE

2346. Also: Once Upon a Time, Don't Wait Too Long, etc.

**WILLIAM TELL**  
and Other Favorites  
Overtures  
LEONARD BERNSTEIN  
NEW YORK PHILHARMONIC  
COLUMBIA

2267. "Stunning, with staggering articulation." —High Fidelity

If You Can Believe Your Eyes and Ears  
**THE MAMAS AND THE PAPAS**  
California Dreamin'  
Monday, Monday  
DUNHILL 10 MORE

2595. Also: Do You Wanna Dance, Spanish Harlem, etc.

Today's Golden Hits  
**ANDRE KOSTELANETZ**  
What Now My Love  
Try To Remember  
Michelle 7 MORE  
COLUMBIA

3449. Plus: A Taste Of Honey, Unchained Melody, Mame, etc.

**RAMSEY LEWIS TRIO**  
THE "IN" CROWD  
PLUS Tennessee Waltz  
Come Sunday  
4 MORE  
CADET

2435. Also: Since I Fell For You, Spartacus, etc.

**DAVE BRUBECK QUARTET**  
Angel Eyes  
Let's Get Away From It All  
Violets For Your Furs  
4 MORE  
COLUMBIA

2159. Also: The Night We Called It A Day, etc.

**NEW KICK!** THE NEW CHRISTY MINSTRELS  
These Boots Are Made for Walkin'  
COLUMBIA

3559. Also: A Corner In The Sun, Home Ward Bound, 8 more

**ANDY WILLIAMS**  
The Shadow of Your Smile  
PLUS Yesterday  
Michelle 9 MORE  
COLUMBIA

2460. Also: Try To Remember, A Taste Of Honey, etc.

**PHILIPPE ENTREMONT**  
Saint-Saens  
Concertos Nos. 2 & 4  
EUGENE ORMANDY  
PHILADELPHIA ORCH.  
COLUMBIA

2217. Glittering performances of these two charming works

**Rhapsody in Blue**  
An American in Paris  
Leonard Bernstein plays Gershwin  
COLUMBIA

1098. "Fierce impact and momentum." —N.Y. World-Telegram

**JACK JONES**  
THE IMPOSSIBLE DREAM  
Plus - Strangers in the Night  
Atie - 9 MORE  
KAPP

2695. Also: The Shadow Of Your Smile, 12 in all

**ROGER MILLER'S GOLDEN HITS**  
England Swings  
King of the Road  
Dang Me  
9 MORE  
SMASH

2276. Also: Kansas City Star, In The Summertime, etc.

**PETULA CLARK**  
MY LOVE  
— plus —  
A SIGN OF THE TIMES  
10 MORE  
WARNER BROS.

2462. Also: We can Work It Out, Dance With Me, 8 more

THE MOVIE SONG ALBUM  
**TONY BENNETT**  
Song from "The Oscar"  
Emily  
10 MORE  
COLUMBIA

2404. Also: Never Too Late, The Pawnbroker, Smile, etc.

**HAPPINESS IS RAY CONNIFF**  
his SINGERS and ORCHESTRA  
Blue Moon  
All by Myself  
10 MORE  
COLUMBIA

2398. Also: Melodie D'Amour, Jamaica Farewell, etc.

**THE SUPREMES**  
I Hear A Symphony  
Plus My World Is Empty  
Without You  
10 MORE  
MOTOWN

2417. Also: Yesterday, Unchained Melody, 12 in all

**MY FAIR LADY**  
AUDREY HEPBURN REX HARRISON  
Original Sound Track  
COLUMBIA

1530. Greater than ever... winner of 8 Academy Awards

**THE HIT SOUND OF DEAN MARTIN**  
A Million and One Shades  
9 MORE  
REPRISE

3432. Also: Come Running Back, Any Time, 7 more

**JAMES BROWN**  
Plays New Breed  
COLUMBIA

2661. Also: Slow Walk, Jabo, Hooks, Cat Bag, 5 more

**ANGELA LANSBURY as MAME**  
ORIGINAL BROADWAY CAST  
COLUMBIA

2672. "The best musical of the season." —CBS News

**FREE** if you join now  
**REVOLUTIONARY SELF-THREADING TAKE-UP REEL**



Just drop the end of the tape over the reel, start your recorder, and watch it thread itself! Unique Scotch® process automatically threads up tape of any thickness, releases freely on rewind.

**SEND NO MONEY - JUST MAIL COUPON!**

**COLUMBIA STEREO TAPE CLUB, Dept. 411-7**  
Terre Haute, Indiana 47808

I accept your special offer and have written in the boxes at the right the numbers of my five FREE tapes. I've also indicated the number of my first selection, for which I'll be billed \$7.95, plus a small mailing and handling charge. I will also receive my self-threading reel FREE!

My main musical interest is (check one):

CLASSICAL  POPULAR

I understand that I may select tapes from any field of music. I agree to purchase five additional selections from the more than 200 to be offered in the coming 12 months, at the regular Club price plus a small mailing and handling charge. Thereafter, if I decide to continue my membership, I am to receive a 4-track, pre-recorded tape of my choice FREE for every two additional selections I accept.

Print Name.....  
First Name Initial Last Name

Address.....

City.....

State..... Zip Code.....

This offer is available only within the continental limits of the U.S. 49

**SEND ME THESE 5 TAPES—FREE!**  
(fill in numbers)

Five empty boxes for entering tape numbers.

**ALSO SEND THIS TAPE AS MY FIRST SELECTION:**

One empty box for entering the first selection number.



# COMPLETE TUNER OVERHAUL

ALL MAKES—ONE PRICE

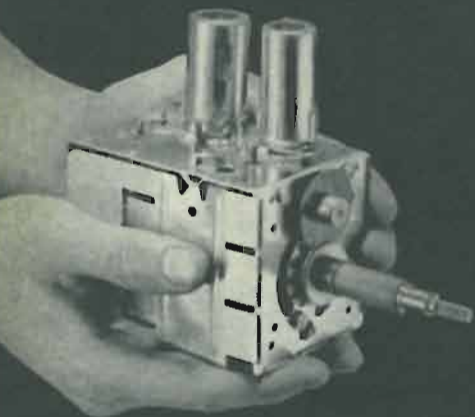

ALL LABOR AND PARTS

(EXCEPT TUBES & TRANSISTORS)\*

# 9.95



VHF



UHF



COLOR



U-V



COLOR TUNERS



TRANSISTOR

Guaranteed Color Alignment—No Addit. Charge

Simply send us the defective tuner complete; include tubes, shield cover and any damaged parts with model number and complaint. Your tuner will be expertly overhauled and returned promptly, performance restored, aligned to original standards and warranted for 90 days.

UV combination tuner must be single chassis type; dismantle tandem UHF and VHF tuners and send in the defective unit only.

Exact Replacements are available for tuners unfit for overhaul. As low as \$12.95 exchange. (Replacements are new or rebuilt.)

Pioneers in TV Tuner Overhauling

# CASTLE

TV TUNER SERVICE, INC.

MAIN PLANT: 5715 N. Western Ave., Chicago 45, Illinois  
 EAST: 41-96 Vernon Blvd., Long Island City 1, N.Y.  
 IN CANADA: Castle Television Services, Ltd., . . .  
 Nation-wide service

## REMOTE-CONTROL BLACKBOARD

Closed-circuit TV can transmit an illustrated lecture from a college professor on campus to a class many miles away. Even though it's expensive, the new system, shown in the photos, makes illustrated lectures possible for about one-fourth the cost of CCTV. It uses ordinary telephone lines, and the class can talk back to the instructor for questions or comments. The lower photo shows a class watching the electronic blackboard to see what the instructor has written on the sending console.



At the instructor's position, an electronic pen is mechanically linked to two pots. As the teacher moves the pen on the transmitting-CRT face, the pots sense the position of the pen on X and Y coordinates. The pots' positions modulate tone transmitters which feed the telephone line.

At the receiving location, the recovered coordinate information deflects the beam of a special storage CRT. This image is then scanned by a small TV camera which feeds any desired number of CCTV monitors. The image on the storage tube may be erased when the instructor is finished with it.

Nearly any type of graphic material—handwriting, diagrams, formulas or sketches—may be used with the system, which was developed jointly by Purdue University and Sylvania Electric Products, Inc.

## COMMERCIAL RADIO TO START IN BRITAIN

A new popular-music radio service with commercials will be started soon by the government of Great Britain. The new agency will be known as the Popular Music Authority (PMA) and will be financed entirely by advertising revenue.

This is in contrast with the prac-

*continued on page 12*

6

◀ Circle 10 on reader's service card

# Radio-Electronics

154 WEST 14TH STREET  
 NEW YORK 10011

HUGO GERNSBACK, *editor-in-chief*  
 M. HARVEY GERNSBACK, *publisher*  
 FOREST H. BELT, *editor*  
 Bruce Ward, *production manager*  
 Robert F. Scott, *W2PWG, technical editor*  
 Thomas R. Haskett, *associate editor*  
 Jack Darr, *service editor*  
 I. Queen, *editorial associate*  
 Allen B. Smith, *science editor*  
 Wm. Lyon McLaughlin,  
*technical illustration director*  
 Nancy Gitchel, *editorial assistant*  
 Adelaide Cassity, *production assistant*  
 G. Aliquo, *circulation manager*  
 Joseph L. Bund, *newsstand director*  
 Cover design by Harry Schlack

RADIO-ELECTRONICS is published by Gernsback Publications, Inc.

Chairman of the Board: Hugo Gernsback

President: M. Harvey Gernsback

Vice President-Secretary: G. Aliquo

Vice-President-Treasurer: Charles A. Raible

## ADVERTISING REPRESENTATIVES

### EAST

John J. Lamson,

RADIO-ELECTRONICS, 154 West 14th Street, New York 10011, 212-255-7755

### MIDWEST

P. H. Dempers Co., 5555 N. Lincoln Ave., Chicago, Ill. 60625, 312-561-0220

### W. COAST/TEXAS/ARKANSAS/OKLAHOMA

J. E. Publishers Representative Co., 8380 Melrose Ave., Los Angeles, Calif. 90069, 213-653-5841; 420 Market St., San Francisco Calif. 94111, 415-981-4527

### UNITED KINGDOM

Publishing & Distributing Co., Ltd., Mitre House, 177 Regent St., London W.1, England

**SUBSCRIPTION SERVICE:** Send all subscription correspondence and orders to RADIO-ELECTRONICS, Subscription Department, Boulder, Colo. 80302. For change of address, allow six weeks, furnishing both the old and new addresses and if possible enclosing label from a recent issue.

**MOVING?** Or writing about subscription? Be sure to fill out form below.

For FASTEST service on address change, missing copies, etc., attach old mailing label in first space below. Otherwise please print clearly your address as we now have it.

OLD ADDRESS (Attach old label if available)

Name .....

Address .....

City ..... State .....

Zip Code .....

### NEW ADDRESS

Name .....

Address .....

City ..... State .....

Zip Code .....

Mail to: RADIO-ELECTRONICS  
 Subscription Dept. Boulder, Colo. 80302



**DEVRY TECH** NOT ONLY TRAINS  
YOU... BUT HELPS YOU GET  
STARTED AT NO EXTRA COST IN  
THE **BIG-MONEY** FIELD OF

# ELECTRONICS!

## ✓ PREPARE AT HOME

Whether you want to prepare for a good-paying new job or for advancement in Electronics with your present employer, DeVry Tech offers specialized educational programs designed to meet your needs. You set up your own HOME LABORATORY and work over 300 construction and test procedures to develop on-the-job type skills. You build a quality Transistorized Meter, a 5-inch Oscilloscope and a special Design Console. DeVry also includes modern "programmed" texts, instructive motion pictures, Consultation Service. Effective? Yes!

## ✓ RESIDENT SCHOOL

If you prefer you may get all of your training in DeVry's U.S. or Canadian resident schools under the close guidance of friendly, experienced instructors. You work with a wide variety of commercial equipment similar to that actually used in industry as you prepare in our laboratories for a technician's job in Communications, Microwaves, Radio-Television, Automation, Radar, Computers, or other branch of Electronics. DeVry even provides part-time job placement service to those who wish to earn extra money while attending day or evening classes.

## ✓ PLACEMENT SERVICE

Meet W. E. Bartz, who has helped thousands of DeVry men toward exciting, profitable careers in Electronics. When YOU complete your program, he will help you too. As Placement Manager in touch with business and industry across the nation, Bartz knows the employer demand for DeVry-trained men. He has cooperated in placing our graduates with thousands of firms!

Men 18-45, start preparing NOW for this vast opportunity field. Soon you should be ready for DeVry's valuable employment help!

**MAIL COUPON TODAY!**

**No Advanced Education or Previous Technical Experience Needed to Get Started**

Your ambition and desire to succeed are more important! DeVry guides you every step of the way toward success.

**Free**

Send coupon for these two factual booklets NOW!



**DEVRY TECHNICAL INSTITUTE**

4141 Belmont Avenue • Chicago, Illinois 60641

Accredited Member of National Home Study Council



HOME LABORATORY EQUIPMENT  
— YOURS TO KEEP!



EXPERIENCED  
INSTRUCTORS



**DEVRY TECHNICAL INSTITUTE**  
4141 Belmont Avenue, Chicago, Ill., 60641 Dept. RE-1-X

Please give me your two free booklets, "Pocket Guide to Real Earnings," and "Electronics in Space Travel"; also include details on how to prepare for a career in Electronics. I am interested in the following opportunity fields (check one or more):

- |  |   |
|--|---|
| <input type="checkbox"/> Space & Missile Electronics | <input type="checkbox"/> Communications         |
| <input type="checkbox"/> Television and Radio        | <input type="checkbox"/> Computers              |
| <input type="checkbox"/> Microwaves                  | <input type="checkbox"/> Broadcasting           |
| <input type="checkbox"/> Radar                       | <input type="checkbox"/> Industrial Electronics |
| <input type="checkbox"/> Automation Electronics      | <input type="checkbox"/> Electronic Control     |

Name \_\_\_\_\_ Age \_\_\_\_\_

Address \_\_\_\_\_ Apt. \_\_\_\_\_

City \_\_\_\_\_ State \_\_\_\_\_ Zip \_\_\_\_\_ Code \_\_\_\_\_

Check here if you are under 16 years of age.

HOME STUDY AND RESIDENT SCHOOL TRAINING  
AVAILABLE IN CANADA

2103





## **GET A FASTER START IN THE COURSE YOU CHOOSE WITH NRI'S REMARKABLE ACHIEVEMENT KIT**

When you enroll with NRI we deliver to your door everything you need to make a significant start in the Electronics field of your choice. This remarkable, new starter kit is worth many times the small down payment required to start your training. And it is only the start . . . only the first example of NRI's unique ability to apply 50 years of home-study experience to the challenges of this Electronics Age. Start your training this exciting, rewarding way. No other school has anything like it. What do you get? The NRI Achievement Kit includes: your first set of easy-to-understand "bite-size" texts; a rich, vinyl desk folder to hold your training material in orderly fashion; the valuable NRI Radio-TV Electronics Dictionary; important reference texts; classroom tools like pencils, a ball-point pen, an engineer's ruler; special printed sheets for your lesson answers—even a supply of pre-addressed envelopes and your first postage stamp.

# ***Learning electronics at home is faster, easier, more interesting with new achievement kit***

Only NRI offers you this pioneering method of "3 Dimensional" home-study training in Electronics, TV-Radio . . . a remarkable teaching idea unlike anything you have ever encountered. Founded more than half a century ago—in the days of wireless—NRI pioneered the "learn-by-doing" method of home-study. Today, NRI is the oldest, largest home-study Electronics school. The NRI staff of more than 150 dedicated people has made course material entertaining and easy to grasp. NRI has simplified, organized and dramatized subject matter so that any ambitious man—regardless of his education—can effectively learn the Electronics course of his choice.

### **DISCOVER THE EXCITEMENT OF NRI TRAINING**

Whatever your reason for wanting knowledge of Electronics, you'll find the NRI "3 Dimensional" method makes learning exciting, fast. You build, test, experiment, explore. Investigate NRI training plans, find out about the NRI Achievement Kit. Fill in and mail the postage-free card. No salesman will call. NATIONAL RADIO INSTITUTE, Electronics Division, Washington, D. C. 20016





## ELECTRONICS COMES ALIVE AS YOU LEARN BY DOING WITH CUSTOM TRAINING EQUIPMENT

Nothing is as effective as learning by doing. That's why NRI puts so much emphasis on equipment, and why NRI invites comparison with equipment offered by any other school, at any price. NRI pioneered and perfected the use of special training kits to aid learning at home. You get your hands on actual parts like resistors, capacitors, tubes, condensers, wire, transistors and diodes. You build, experiment, explore, discover. You start right out building your own professional vacuum tube voltmeter with which you learn to measure voltage and current. You learn how to mount and solder parts, how to read schematic diagrams. Then, you progress to other experimental equipment until you ultimately build a TV set, an actual transmitter or a functioning computer unit (depending on the course you select). It's the practical, easy way to learn at home—the priceless “third dimension” in NRI's exclusive Electronic TV-Radio training method.

## SIMPLIFIED, WELL-ILLUSTRATED “BITE-SIZE” LESSON TEXTS PROGRAM YOUR TRAINING

Lesson texts are a necessary part of training, but only a part. NRI's “bite-size” texts are as simplified, direct and well-illustrated as half a century of teaching experience can make them. The amount of material in each text, the length and design, is precisely right for home-study. NRI texts are programmed with NRI training kits to make things you read come alive. As you learn, you'll experience all the excitement of original discovery. Texts and equipment vary with the course. Choose from major training programs in TV-Radio Servicing, Industrial Electronics and Complete Communications. Or select one of seven special courses to meet specific needs. Check the courses of most interest to you on the postage-free card and mail it today for your free catalog.

Available Under  
**NEW  
GI BILL**

If you served since  
January 31, 1955, or  
are in service, check GI  
line in postage-free card.

## *custom training kits “bite-size” texts*

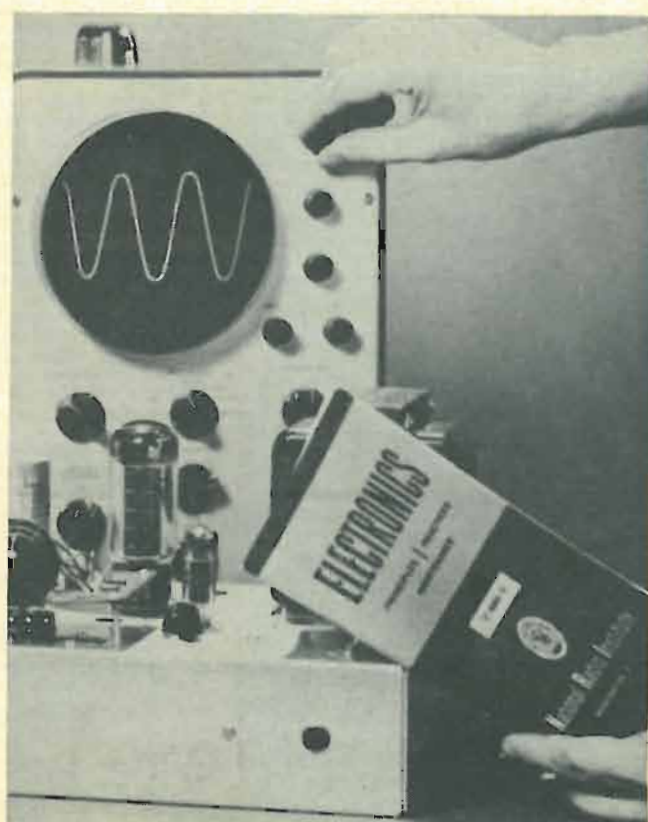



**NEWS BRIEFS continued**

tice of the 44-year-old BBC, the government-controlled monopoly that has furnished Britons with commercial-free radio fare until now. PMA will broadcast on broadcast-band channels now used by BBC's Light Programme, one of three BBC services.

Chief reason behind the decision was the nagging existence of "pirate" stations which operate transmitters from offshore ships or abandoned gun forts on reefs, selling time and broadcasting modern popular music. These stations are to be outlawed.

The new radio service has a precedent, however—the 12-year-old ITA (Independent Television Authority). BBC television is commercial-free, like its radio service, but ITA carries advertising on its channel.

**MORE SHORTWAVE BROADCASTING**

For the first time in 4 years, conditions have opened up on the 11-meter shortwave band. Signals are being received on the 25–26-MHz international frequencies, due to increased sunspot activity. Not only will overseas broadcasts be available for SWL's,

the 27-MHz Citizens band will undoubtedly be plagued by skip interference.

FM listeners in the New York City vicinity can hear Radio Peking, Radio Moscow and Radio Havana without a shortwave receiver. New York's WRFM (105.1 MHz) tapes English-language news and comments from these three Iron-Curtain SW stations for playback to their audience. The excerpts are heard intermittently from 8 to 11 pm nightly. WNYW, WRFM's SW affiliate, returns the courtesy by broadcasting features about the US to its overseas listeners at the same time.

**HANDWRITTEN NUMBERS**

Most information-processing devices can recognize only printed numerals. IBM's 1287 can read handwriting—at least the numbers from 1 to 10, and the letters C, S, T, X and Z. Now being offered for lease or sale, the machine will be useful for coding sales slips and bank deposits, and for many similar applications. The five letters were selected for their ease of recognition.

**NOBEL PRIZE TO SCIENTIST**

The Nobel Prize for physics has been awarded to Dr. Alfred Kastler, a French scientist. Dr. Kastler's experiments, which began in 1949, produced knowledge of energy levels inside the atom. His work has been called basic to the development of the laser.

**NO-CONTACT SWITCH**

Eliminating moving parts and contacts, a new switch developed in England is not affected by oil or dirt deposits. The device works when a piece of metal is inserted in a magnetic field between two gaps. Interrupting the field triggers a circuit which can be used to control any on-off function. Power required for the switch is 27 mW; maximum switching speed is 100 operations per second. The encapsulated switch measures 2 3/8 x 1 3/8 inches and will operate up to 113°F. END

**CORRECTION**

There is an error in Fig. 3 of the article "Solid-State and Hi-Z Too" on page 48 of the November issue. As the circuit is drawn, R2 is shorted out. You can correct this on your diagram by deleting the horizontal line from the junction of C1 and R2 to the gate of Q1. This places R2 in series with the gate and C1 just as it is in Fig. 1.

Our thanks to Dr. Kurt J. Schulz of Gary, Ind. for calling this to our attention. END



**The only Theatre Organ available in kit form — for only \$1350.**

You've asked for it and here it is — the NEW Schober THEATRE ORGAN that you assemble yourself. For the first time in kit form, a real Theatre Organ with that rich, full, old time theatre pipe organ sound. You create the organ, then you create the music!

For years you've been able to buy organs in kit form from Schober: The Recital (fully AGO), the Console II (the best spinet organ available today) and the Spinet (for the most music at the lowest price). Now to join them, we present the Schober Theatre Organ.

The Schober Theatre Organ has the same quality features found on all Schober Organs, and in addition... special voicing, curved console design, two 61-note keyboards, 2-octave radiating pedal clavier, 8 octaves of tone distributed over 5 pitch registers (including a 1-foot register!), 35 speaking organ stops, 8 realistic percussion stops, 4 couplers, and vibrato tablet—48 tablets in all. And all at a truly remarkable low price... you save over \$1,500 (well over 50%) from comparable theatre organs.

**Easy Step-By-Step Instructions.**

You'll enjoy assembling this authentic and versatile instrument from transistor and miniature components too. Just follow easy step-by-step instructions written in everyday language which anyone can understand. You'll have an unequalled pride when you're finished that only can come from assembling it yourself.

And you'll have an organ you can learn to play easily and quickly—just follow one of the self teaching courses available from us.

The Theatre Organ price starts at \$1,350, depending on the options you select. This price includes a beautiful walnut console (other woods available) or you can save an additional amount by building your own from plans available from us. Options available include combination action, genuine reverberation, percussion, and amplifiers and speakers.

**THE Schober Organ CORPORATION**  
43 West 61st Street, New York, N.Y. 10023

**A COMPLETE THEATRE ORGAN!**

All you do is have the fun of assembling it from kits and detailed, step-by-step instructions.

**Includes** console, keyboards, bench, pedals, electronics—everything you need except amplifier and speaker system, which are extra—or use your own. Percussions, combination action, and reverberation are options.

**Features** fully transistorized electronics, regulated power supplies, all printed circuit construction and gold switch contacts.

**Combination Action** Ten buttons select preset combinations of stops—actually move the stop tablets as in fine pipe organs—to give instant total changes of tonal effects. You can alter the preset combinations any time you like. Action is brand new electro-pneumatic type — silent, dependable.

**Percussion** Eight percussion stops provide exciting realism. Celesta, harpsichord, piano, mandolin, xylophone, chrysoglott, orchestral bells, single or reiterating, are played just like the real thing—and sound that way — alone or along with regular organ stops.

*Uncompromising Organ Quality from Easy-to-Assemble Kits*

**Free Information.** Send today for your free copy of Schober's 16-page full-color booklet—plus free 7" recording—with full information on all Schober Organs, priced from \$550.

The Schober Organ Corp., Dept. RE-47  
43 West 61st St., New York, N. Y. 10023

Please send me Schober Organ Catalog and FREE 7-inch "sample" record.

Enclosed please find \$2.00 for 12-inch quality LP record of Schober Organ music. (\$2.00 refunded with purchase of first kit.)

Name.....

Address.....

City.....State.....Zip No.....

Circle 12 on reader's service card

Circle 13 on reader's service card



# A dozen ways to cut down on color call-backs.

In color TV set repair, these 12 Sylvania tubes do most of the work. They cut down on call-backs because their quality is assured by thorough testing before they leave our plant.

Sylvania makes color replacement receiving tubes for every major color TV set manufactured. Available quickly from your Independent Sylvania Distributor.

**SYLVANIA**  
SUBSIDIARY OF  
GENERAL TELEPHONE & ELECTRONICS **GTE**

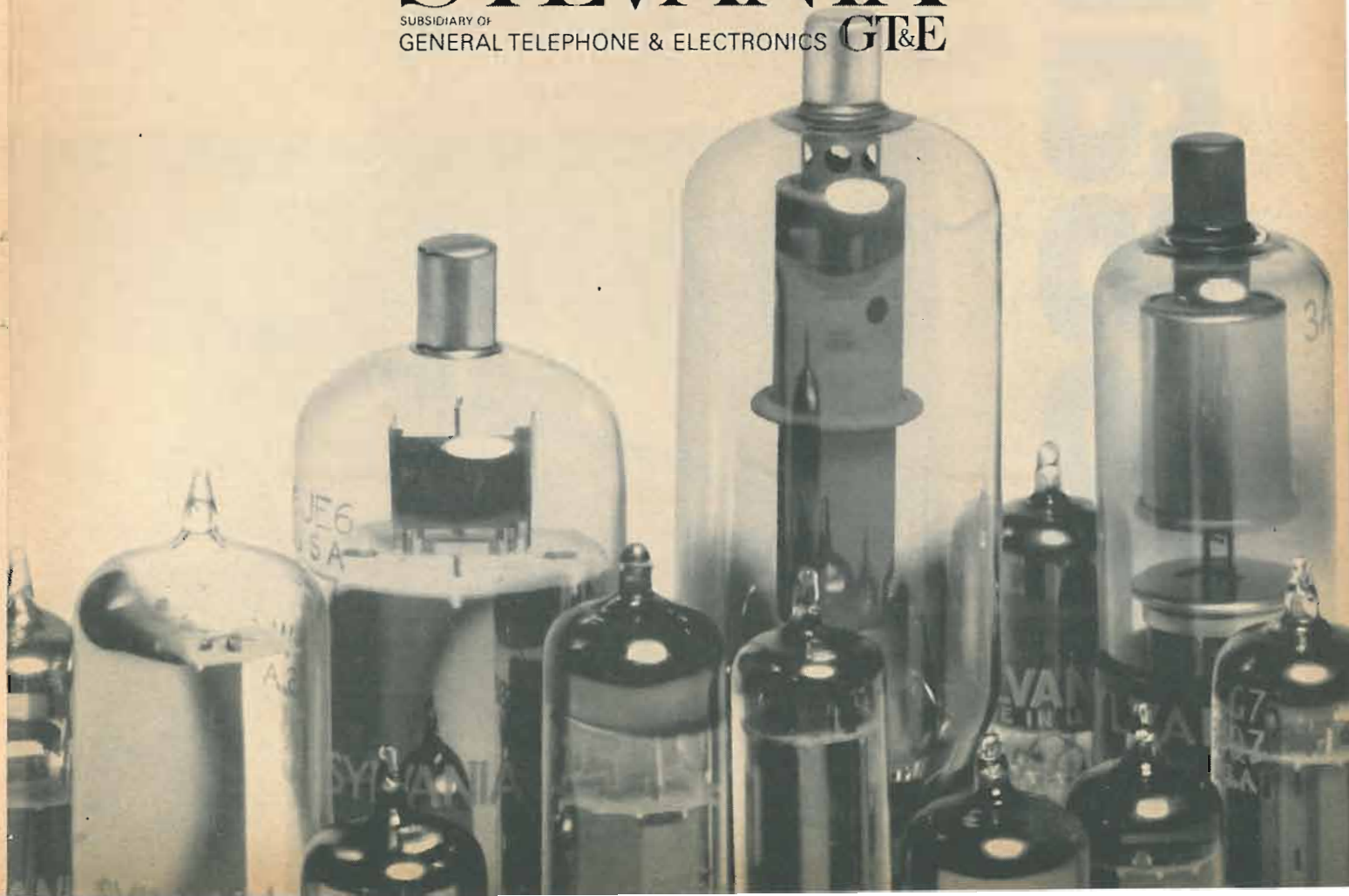



# assault on perfect

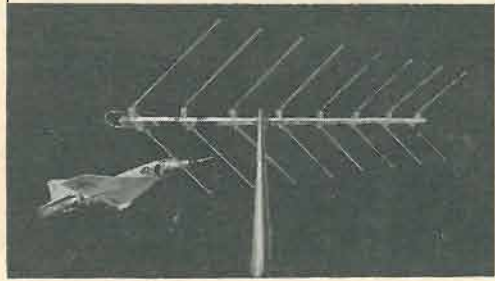

Back in 1962, we invented a new kind of TV antenna.

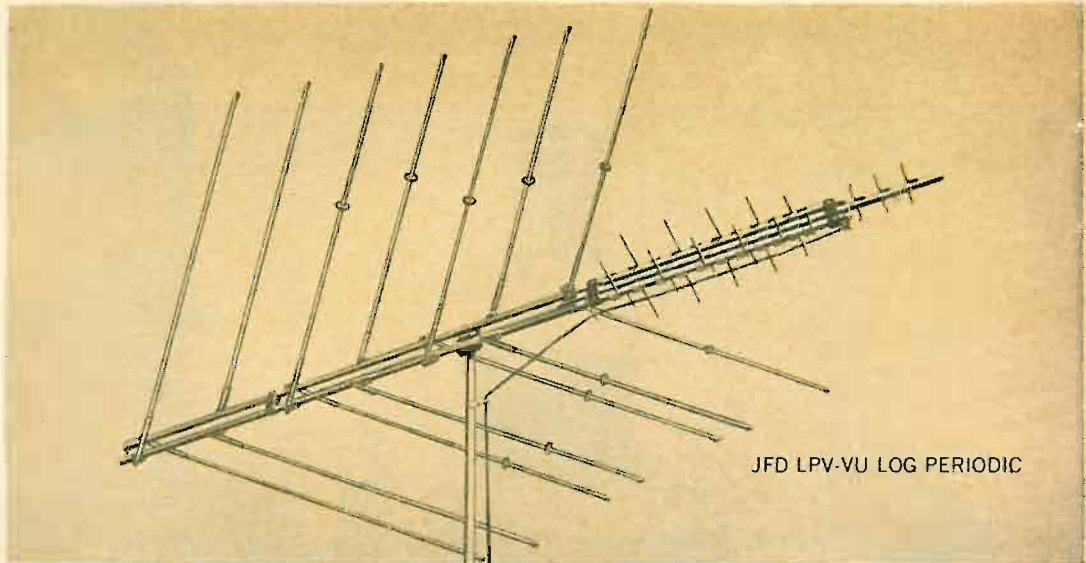

JFD LPV-VU LOG PERIODIC

Licensed under one or more of U.S. patents 2,958,081; 2,985,879; 3,011,168; 3,108,280; 3,150,376; 3,210,767, RE. 25,740 and additional patents pending in U.S.A. and Canada. Produced by JFD Electronics Co. under exclusive license from the University of Illinois Foundation.

Circle 14 on reader's service card



# tion: PERFECTION CONQUERED

We did not improve on an old antenna. We started from scratch to design a new one. *Really new.*

It wasn't easy. And it wasn't cheap. But it worked like mad.

We called it the LPV Log Periodic. Its performance caught our competitors with their charts down. But it wasn't long before they came up with LPV copies in every way—except in performance.

Meanwhile back at the JFD labs in Champaign, Illinois, our scientists and engineers continued their "assault on perfection." In 1963, they again shattered antenna precedent by coming up with the *first* combination VHF/UHF/FM log periodic antenna, the LPV-VU. Instead of three different antennas, installers now needed only *one* LPV-VU and *one* download.

Our competitors scoffed at the idea. They said it couldn't be done. Until the "eyepopping" results started to roll in. Then there was a mad scramble for the LPV-VU bandwagon.

These "me-too" antennas looked like the LPV-VU Log Periodic. Sounded like it, too. But their charms were skin-deep.

Only the JFD LPV-VU delivered deluxe 82-channel log periodic performance. Because only the JFD LPV-VU followed the genuine patented log periodic concept of the University of Illinois Antenna Research Laboratories. Thanks to the protection of eleven different LPV-VU U.S. patents issued and pending—more than those of any other antenna.

You would think by now our Research and Development people in Champaign would leave well enough alone. But no. These "Young Turks" have gone and done it again. This time it's a new all-band log periodic design—the LPV-CL Color Laser. (Must be that "assault on perfection" bug they've still got up their polinear recorder.)

Why did we call it the Color Laser?

Well, engineers tell us that laser light beams with their tremendous bandwidth capacity are the communications carrier of the future. And we believe that our new VHF/UHF/FM Color Laser with its extreme bandwidth, among other unique characteristics, is the antenna of the future—only it's available to you *now*. How does the Color Laser deliver unsurpassed natural color, black and white across 82 channels, and FM, too?

Three reasons: (1) *Patented \*VHF "cap-electronic" Log Periodic V Design*, (2) a new

*broad band UHF "zoned" trapezoid driver*, (3) a new *disc-on-rod UHF director system*. And there are patents issued and pending on all three.

We've also spun off the LPV "cap-electronic" Log Periodic section of the Color Laser. It forms the heart of a great new VHF antenna series we've named the LPV-TV.

This "assault on perfection" of ours involved a complete new mechanical design, as well. Results: "fast-lok" element brackets, "hot" twin booms (no lossy harnesses or transformers), new super-strength double U-bolt profiles, high reliability cylindrical capacitors, plus our electrically conductive gold alodized aluminum.

If you're the breed of professional contract installer or self-servicing appliance dealer who *never* settles for less than the best, we have a suggestion. Use a JFD LPV-CL Color Laser or LPV-TV Color Log Periodic on your next installation. See what it feels like to install the *best* of all in performance and customer satisfaction.

You will also see why our research and development people have now changed their watchword from "assault on perfection" to "perfection conquered".

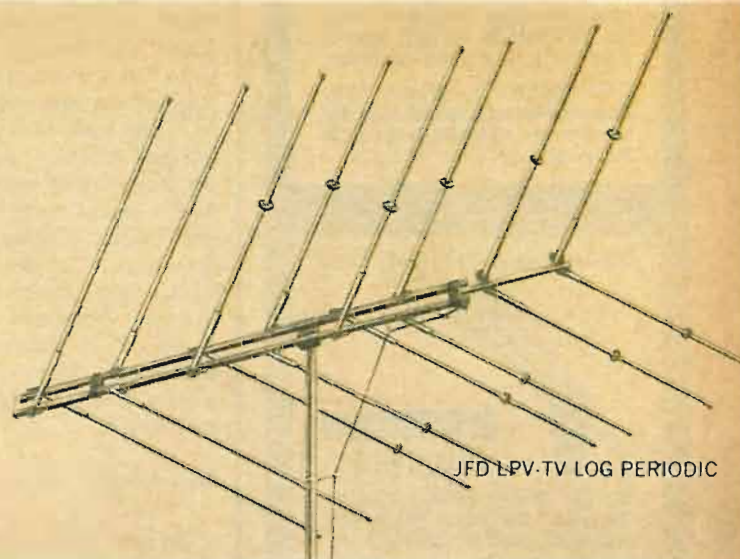
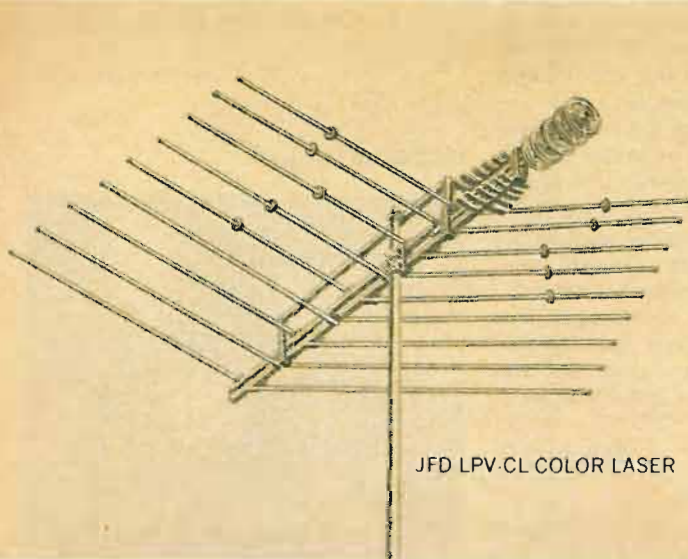

Licensed under one or more of U.S. Patents 2,955,287 and 3,015,821 and additional patents pending.

# JFD®

**JFD ELECTRONICS CO.**

15th Avenue at 62nd Street, Brooklyn, N.Y. 11219

JFD International, 64-14 Woodside Ave., Woodside, N.Y. 11377 JFD Canada, Ltd., Canada

JFD de Venezuela, S.A., Avenida Los Haticos 125-97, Maracaibo, Venezuela



# problem solving micro-phones

by **SHURE**



**PROBLEM:**  
"Pop" & Feedback

**SOLUTION:**  
Unisphere I® Microphone

Provides superb feedback control and uniform pickup pattern for solving difficult public address problems—plus the added problem-solving ability afforded by spherical filter assemblies that effectively control explosive breath sounds ("POP") and wind noise in outdoor locations. They are particularly recommended for close-talking applications and permit superior utilization of space on small stages or studios. And, they control echoing in partially filled halls ("BOOM"). For hand or stand.

**UNISPHERE I—Model 565.** Dual-impedance, small size for maximum handability. List Price: \$95.00

*budget a problem, too?*



**SHURE**  
Unisphere A

Budget priced version of UNISPHERE I for use in low-budget systems. Unidirectional, "pop" suppressing. Model 585 SA High Impedance; 585 SB Low Impedance. List Prices: Model 585 SA \$65.00; Model 585 SB \$58.00.

Write for Data Sheet:

**SHURE BROTHERS, INC.**  
222 HARTREY AVENUE  
EVANSTON, ILL. 60204

U.S. Patents 3,132,713 and 3,240,893

Circle 15 on reader's service card

# Correspondence



## BEGINNERS' CLUB

Dear Editor:

The British Amateur Electronics Club was formed recently for the benefit of all who are interested in electronics as a hobby.

I think it would be of considerable interest to our members to exchange ideas with electronic enthusiasts in the USA and, also, I hope they would like to hear from us.

26 Forrest Road  
Penarth,  
Glam:  
Great Britain

CYRIL BOGOD

## SLIPS!!

Dear Editor:

In my letter "Hertz Not New" in the November issue, I have apparently been edited into making an incorrect statement. In the original letter, I said: "... 'pico' took 40 years to get into general use. It was first . . . referred to in the *US Signal Corps Manual* in 1921 . . . and was actually adopted (and later abandoned) by *QST* in 1926." In the magazine the letter reads: "Hertz was first referred to . . ."

The term *hertz* was not used in the *Manual* in 1921. Just to make sure, I got the ancient work down, and found that it was already using the Americanism "cycles." (In some problems and explanations, "cycles per second" was spelled out.) Radio frequencies were invariably converted to wavelength and expressed in meters, and only in describing the Alexanderson alternator was a frequency as high as "200,000 cycles" mentioned.

ERIC LESLIE

New York, N. Y.

## LADDER LINGO

Dear Editor:

About the problem on the resistance of an infinite ladder network, which appeared in "What's Your EQ?" in the June issue. This has an interesting side-

light, especially for electronics men interested in mathematics.

The answer,  $\frac{-1 + \sqrt{5}}{2}$ , is equal to

the reciprocal of "tau" (also called "phi"), which appears many times over in geometric design, architecture, and art, as well as in mathematics. Evidently we may now add electronics to the list.

Briefly stated, tau is the ratio of length to width (aspect ratio) of a rectangle, the semiperimeter of which bears the same ratio to its length, as its length bears to its width. Tau is approximately equal to 1.618034.

A curious property of tau is that it is the only positive number which becomes its own reciprocal by subtracting 1 from it. In view of the ladder network problem this means that if you add a single 1-ohm resistor in series with the input, the new network has a resistance

equal to tau, or  $\frac{1 + \sqrt{5}}{2}$ . A little

manipulation will verify that this is the reciprocal of the original expression above.

Another interesting aspect of tau, which for the astute observer will tie it in directly with the ladder network problem, is the following alternate way of expressing it:

$$\tau = 1 + \frac{1}{1 + \frac{1}{1 + \frac{1}{1 + \dots}}}$$

[Tau or phi—it's Greek to me.—  
Editor]

MILTON BADT, JR.

APO, N. Y.

## GOOD OLD DAYS



Dear Editor:

Like thousands of radio engineers and amateurs, I received my greatest inspiration from Hugo Gernsback's vari-

*continued on page 22*



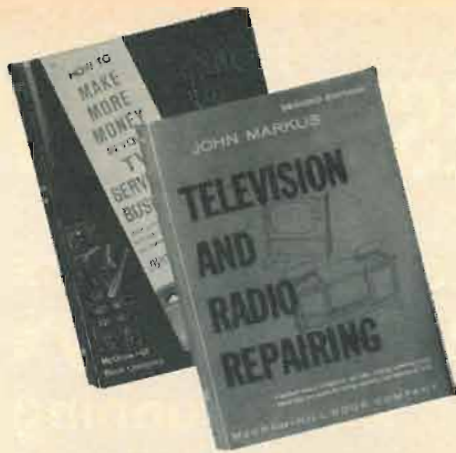

# Here's how you can make BIG PROFITS RIGHT NOW in TV and radio repair...

even if you've never looked inside a set before!  
(And do a better job if you have.)

## THE MARKUS SIMPLIFIED TV SERVICER

**EARN GOOD MONEY, FAST!** Now's the time to get in on the booming TV and radio repair business, and this 2-volume, fast-action plan can start you off immediately. In fact, the author pledges: "After you've read the first 9 chapters, you'll fix 3 out of 4 sets!" AND, if you're already an experienced man, you're going to discover hundreds of ways to build your business—and pile up new profits.

**ALL IN PLAIN ENGLISH,** gets right down to cases. Here in almost 1000 pages is everything you need to know, from how to fix sets (right from the start) to how to win and hold customers. In a simple, no-nonsense style, this Servicer Set covers all the basics of TV and radio repair in step-by-step detail. **For the seasoned serviceman it's also an ideal guide to recent advances—printed circuits, transistors, selenium and germanium rectifiers, remote control devices, and all the rest.**

And you have to know **THE BUSINESS SIDE.** Half of this comprehensive set gives you every technique you'll need to run your business—whether full or part time—for the biggest profit. You'll quickly learn how to advertise yourself, the best insurance, how to really save on taxes, how to make collections, about service charges, and much, much more.

**HOW TO DO IT—NOW!** Right from the very start you'll see exactly how to recognize trouble symptoms . . . how to check to make sure . . . how to order new parts and install them . . . how to hire and manage other servicemen (it's a fast-growing business!) . . . how to avoid profit leaks . . . and how to set up a combined sales and service operation where the earnings are *big* (\$25,000 a year and up).

**LEARN HOW TO:** improve dim television pictures

- decide on fair and profitable rates for specific jobs
- identify interference, power trouble
- choose proper replacement filter capacitors
- select the best spot for your shop
- gain *free* word-of-mouth advertising
- expand receiver sales
- install, adjust, repair all kinds of antenna, *and more*

### JOHN MARKUS MEANS BUSINESS

John Markus combines a lifetime of experience in repairing TV and radio sets with 30 years of writing in the field. During his career he has served as Technical Editor of *Mechanix Illustrated* in the Radio Department; has edited and written lesson texts for National Radio Institute; was Radio Editor of *Science and Mechanics*; was Feature Editor of *Electronics* magazine. Currently, John Markus is Manager, Technical Information Research, McGraw-Hill, Inc. His experience on the bench, in the field, and as a teacher can mean big money in *your* pocket.

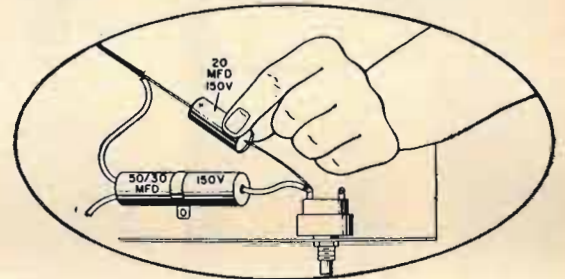

**OVER 300 ILLUSTRATIONS.** Making every step crystal clear on both the technical and business side, hundreds of diagrams, charts, drawings and tables show you how to start and run your own money-making business. For example you'll see in pictures every repair step, all parts; and you'll find complete, illustrated troubleshooting instructions.

**FREE SERVICE AIDS!** Just for looking over the MARKUS SIMPLIFIED TV SERVICER we will send you these three valuable service aids to keep, even if you don't buy the books:

- 1) **TV Detect-O-Scope**—shows how to pinpoint common troubles at a glance (sells ordinarily for \$1.00).
- 2) **Blue Book of Standard Service Charges**—tells what fees to charge for top profit, happy customers (sells ordinarily for \$1.00).
- 3) **Guide to Quick Learning**—shows how to telescope years of study into a few short weeks (this one can't be bought at any price).

**10 DAYS FREE EXAMINATION!** You pay *not one cent* until you have looked the MARKUS SIMPLIFIED TV SERVICER over on a 10 day free trial, and you're satisfied that it will do everything claimed for it. Then—and even if you decide to return the books—keep with our compliments the TV Detect-O-Scope, The Blue Book of Standard Service Charges and the Guide to Quick Learning.

YOUR FIRST STEP TO PROFIT

MAIL THIS COUPON TODAY!

McGraw-Hill Book Co., Dept. 23-RE-17  
330 W. 42 St., New York, N. Y. 10036

Send me **MARCUS SIMPLIFIED TV SERVICER** for 10 days on approval. In 10 days I will remit \$16.90 plus a few cents for delivery costs (and local tax, if any), or return book postpaid.

Name (print) \_\_\_\_\_

Address \_\_\_\_\_

City \_\_\_\_\_

State \_\_\_\_\_ Zip \_\_\_\_\_

For prices and terms outside U.S. write to McGraw Hill Int'l. N.Y.C. 23-RE-17



# Join "THE TROUBLESHOOTERS"

**They get paid top salaries  
for keeping today's  
electronic world running**

Suddenly the whole world is going electronic! And behind the microwave towers, push-button phones, computers, mobile radio, television equipment, guided missiles, etc., stand **THE TROUBLESHOOTERS**—the men needed to inspect, install, and service these modern miracles. They enjoy their work, and get well paid for it. Here's how you can join their privileged ranks—without having to quit your job or go to college in order to get the necessary training.

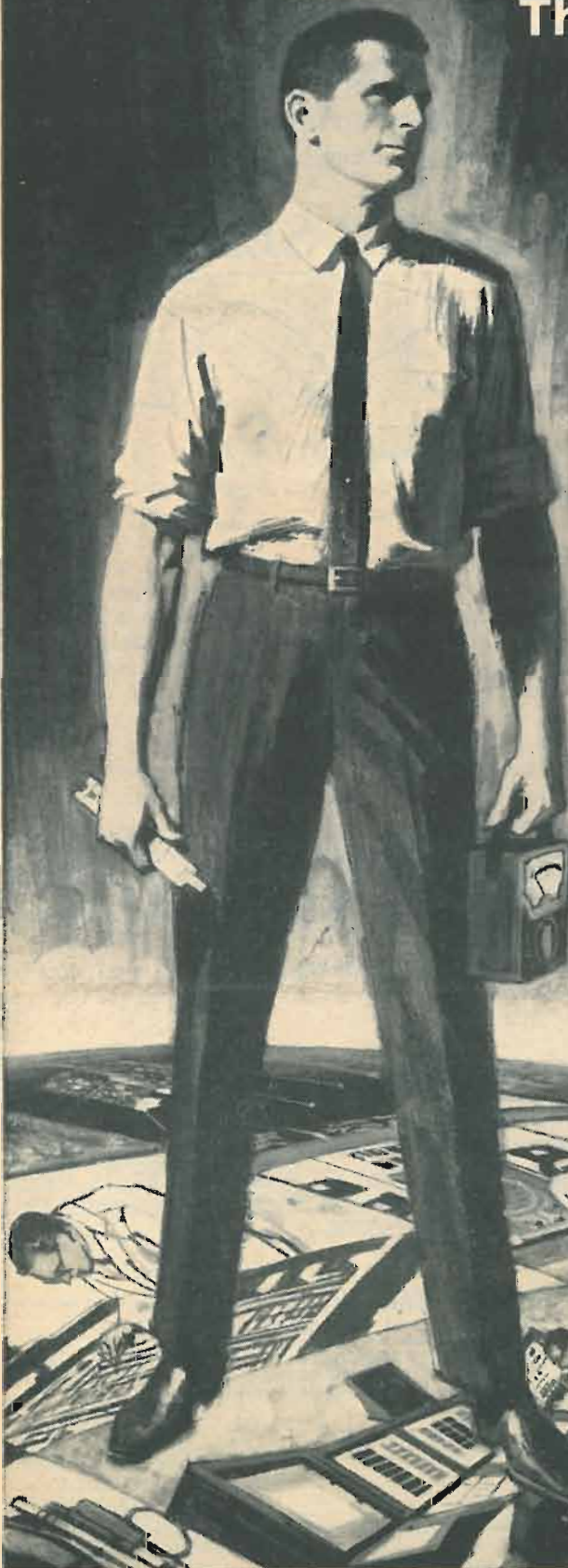



**J**UST THINK HOW MUCH in demand you would be if you could prevent a TV station from going off the air by repairing a transmitter...keep a whole assembly line moving by fixing automated production controls...prevent a bank, an airline, or your government from making serious mistakes by repairing a computer.

Today, whole industries depend on electronics. When breakdowns or emergencies occur, someone has got to move in, take over, and keep things running. That calls for one of a new breed of technicians—The Troubleshooters.

Because they prevent expensive mistakes or delays, they get top pay—and a title to match. At Xerox and Philco, they're called Technical Representatives. At IBM they're Customer Engineers. In radio or TV, they're the Broadcast Engineers.

What do you need to break into the ranks of The Troubleshooters? You might think you need a college diploma, but you don't. What you need is know-how—the kind a good TV serviceman has—only lots more.

### Think With Your Head, Not Your Hands

The serviceman, you see, "thinks with his hands." He learns his trade by taking apart and putting together, and often can only fix things he's already familiar with.

But as one of The Troubleshooters, you may be called upon to service complicated equipment that you've never seen before or *can't* take apart. This means you have to be able to take things apart "in your head." You have to know enough electronics to understand the engineering specs, read the wiring diagrams, and calculate how a circuit should test at any given point.

Now learning all this can be much simpler than you think. In fact, you can master it without setting foot in a classroom and without giving up your job!

### AUTO-PROGRAMMED™ Lessons Show You How

For over 30 years, the Cleveland Institute of Electronics has specialized in teaching electronics at home. We've developed special techniques that make learning easy, even if you've had trouble studying before.

For one thing, our AUTO-PROGRAMMED™ lessons build your knowledge as you'd build a brick wall—one brick at a time. Each piece rests securely on the one that came before it.

#### ENROLL UNDER NEW G. I. BILL

All CIE courses are available under the new G. I. Bill. If you served on active duty since January 31, 1955, OR are in service now, check box on reply card for G. I. Bill information.

In addition, our instruction is personal. When your teacher goes over your assignment, no one else competes for his attention. You are the only person in his class. He not only grades your work, he analyzes it to make sure you are thinking correctly. And he returns it the day it's received so that you can read his comments and corrections while everything is fresh in your mind.

### Always Up-To-Date

To keep up with the latest developments, our courses are constantly being revised. This year CIE students are getting new lessons in Laser Theory and Application, Microminiaturization, Single Sideband Techniques, Pulse Theory and Application, and Boolean Algebra.

In addition, there is complete material on the latest troubleshooting techniques including Tandem System, Localizing through Bracketing, Equal Likelihood and Half-Split Division, and In-circuit Transistor Checking. There are special lessons on servicing two-way mobile equipment, a lucrative field in which many of our students have set up their own businesses.

### Your FCC License—or Your Money Back!

Two-way mobile work and many other types of troubleshooting call for a Government FCC License, and our training is designed to get it for you. But even if your work doesn't require a license, it's a good idea to get one. Your FCC License will be accepted anywhere as proof of good electronics training.

And no wonder. The licensing exam is so tough that two out of three non-CIE men who take it fail. But CIE training is so effective that 9 out of 10 of our graduates pass...on their very first try. That's why we can offer this warranty with confidence: *If you complete one of our license preparation courses, you'll get your license—or your money back.*

### Mail Card for 2 Free Books

Want to know more? Mail the postage-paid reply card bound here. We'll send our 40-page catalog describing our courses and the latest opportunities in Electronics. We'll also send a special book on how to get a Commercial FCC License. Both are free. If the card is missing, just send us your name and address.



# CIE

**Cleveland Institute of Electronics**

1776 E. 17th St., Dept. RE-29, Cleveland, Ohio 44114

Accredited Member National Home Study Council  
A Leader in Electronics Training... Since 1934





# How "saving" 50¢ can ruin a \$700 color TV system!

The coupler is probably the least expensive item in a home TV system . . . yet the wrong coupler can send the investment in a top-quality distribution system and TV set right down the drain.

At Blonder-Tongue, the same engineering skill and meticulous quality control goes into couplers that goes into our professional MATV products. The result: high isolation between sets, extremely low insertion loss and sharp pictures (they're backmatched).

Blonder-Tongue gives you variety, too . . . the widest variety of color-approved, all-channel coupler models in the industry:

**A-102U/V**—deluxe 300-ohm model connects 2 sets to one downlead.

**A-104/UV**—similar to A-102U/V except for 4 sets.

**MDC-2VU**—connects two coax (75-ohm) cables from TV sets to a single coax downlead.

**TV-2**—economy indoor model. Connects two sets to a single 300-ohm twin-lead. Not recommended for weak signal areas.

Quality combiners and splitters are also essential to a good all-channel color TV system. When you specify Blonder-Tongue, you get high quality, low loss and high isolation.

**UVF-1**—deluxe 300-ohm weatherproof model. Provides separate UHF, VHF and FM outlets from downlead carrying all three signals or feeds a single downlead from separate UHF, VHF and FM antennas.

**UVF-C/S**—a lower priced version of the UVF-1.

**A-107**—deluxe, weatherproof unit combines UHF and VHF antennas to one 300-ohm downlead or provides separate UHF and VHF output at set.

**UV-C/S**—indoor unit provides separate UHF and VHF outputs from a single 300-ohm cable carrying both signals, for connection to converter or TV set with separate UHF and VHF inputs.

Write for free catalog #74.

Blonder-Tongue Laboratories, Inc., 9 Alling Street, Newark, N.J.

*Blonder-Tongue, the name to remember, for TV reception you'll never forget*

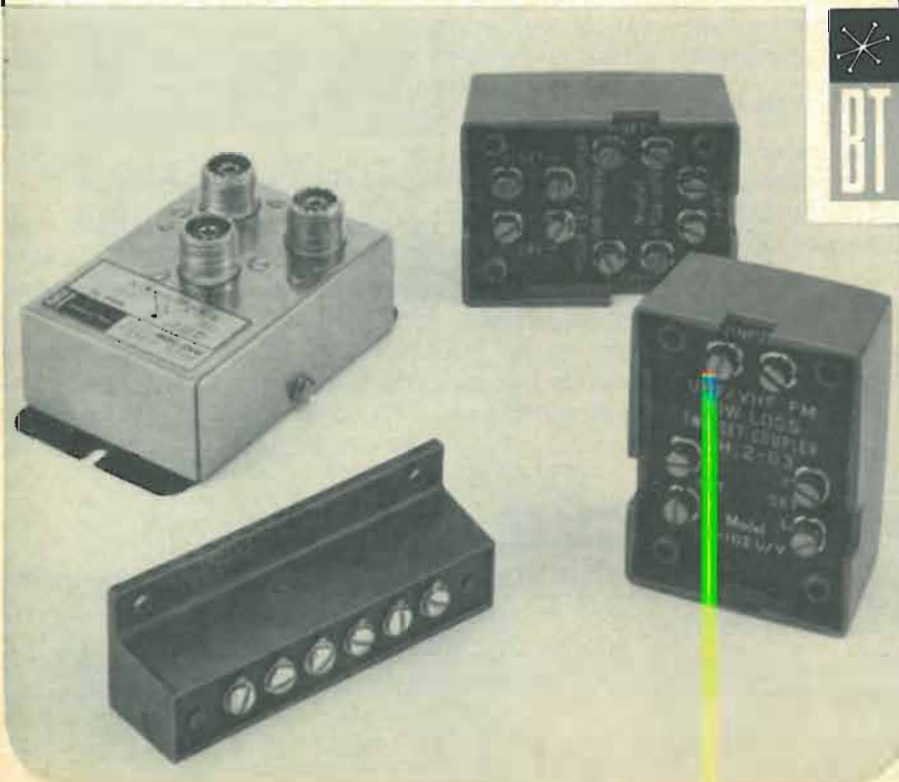

Circle 17 on reader's service card

## CORRESPONDENCE continued

ous "wireless" activities in the years prior to World War I.

I am enclosing an early photograph of my first wireless station. This picture brings back many fond memories, including falling to sleep almost every night with an Electro Importing Co. catalog in my hand. It was my "bible."

WILLIAM W. HARPER

W6TQ  
Pasadena, Cal.

## SAD DAY FOR COLOR TV

Dear Editor:

I want to express my sympathy to the bereaved families of the customers, dealers, and technicians who read the article "Is Color A TV-Man Job?" in the September 1966 issue (page 78). I do hope a few escaped the fate predicted by the blurb which ran directly under the headline:

"Customers, dealers, technicians all still have serious doubts about color television. This article should lay many of them to rest."

RICHARD H. DORF

New York, N.Y.

[And the industry already with a shortage of service technicians! Unforgivable.—Editor.]

## MORE HELP ON PMDVM

Dear Editor:

The "Poor Man's Digital Voltmeter" I built from the article in the August 1966 issue suffers errors due to stray or superimposed ac components at 60 Hz (or multiples thereof, depending on exact phase relation to the chopper timing). A filter (see diagram) having a time constant of about 100,000  $\mu$ sec (.1 sec) will remove these errors but will limit the lowest range to 1 volt full scale.

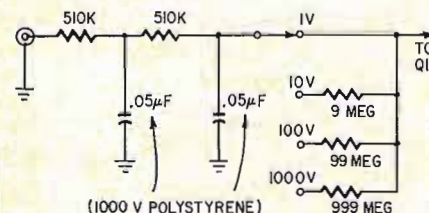

PLACE SHIELD AROUND FILTER, ATTENUATOR, Q1 AND Q2.

A better solution would be to provide chopper drive at about 6,000 Hz. Total filter resistance could then be reduced to 10K to restore the lower ranges, but more extensive shielding would probably be needed to reduce stray coupling. The unit could then be operated on a built-in battery.

BRUCE R. RILEY

Cocoa Beach, Fla.

END



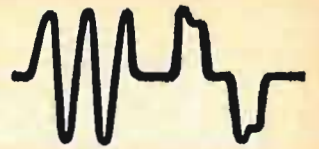

## Choosing electrolytic capacitors for color TV



When you need to replace an electrolytic capacitor in a color television, it pays to select the best. Your customer has a lot of dough invested in his color set, and he won't settle for less than top performance. And his eye can see sub-standard performance in color that would go unnoticed in black-and-white.

Color TV is tough on electrolytics. Ambient temperatures run hotter, because of the greater number of tubes and resistors inside crowded cabinets. Ripple currents are higher, so the capacitor has to do a better job of getting rid of internally generated heat. Voltage ratings are higher, too; most electrolytics in color TV are 400 volts or higher.

It's no surprise that leading color TV makers are pretty darn particular about the electrolytics that they use as original equipment. They demand a true high-voltage, high-temperature, high ripple capacitor... not one that's simply made to sell at bottom price. And meeting these demands is the way Mallory got to be the top supplier of electrolytics for color TV. We're the guys who pioneered the 85°C capacitor, who have consistently increased ripple current capacity, and who have the reputation of leadership in high voltage ratings.

Here's our tip of the month. To save yourself time, get a copy of our new cross reference, "Exact Replacement Metal Can Electrolytic Capacitors for Color TV". It lists the original part number and the catalog number of the corresponding Mallory replacement for 38 leading color TV manufacturers. To save yourself costly call backs, use only the best... and that's one of the Mallory FP-WP series, made to original equipment specs. To get everything you need for color TV service, see your Mallory distributor. He stocks Mallory power resistors, circuit breakers, carbon and wire-wound controls and Discap® ceramic capacitors.

For a copy of the Color TV cross reference, ask your Mallory Distributor, or write to Mallory Distributor Products Company, a division of P. R. Mallory & Co. Inc., Indianapolis, Indiana 46206.

Circle 18 on reader's service card





## new Sams books

### 99 Ways to Improve Your CB Radio

by Len Buckwalter. Tells how to operate, service, and maintain CB equipment for optimum performance. Describes desirable antenna systems; explains how to suppress noise; covers alignment, repair, and maintenance; discusses useful accessories. Includes tips on operating methods—mike techniques, how to evaluate S-units, operating positions, etc. Invaluable to anyone in CB radio. 128 pages; \$2.50 5 1/2 x 8 1/2". Order ICB-1, only.

### How to Build Speaker Enclosures

by Alexis Badmaieff & Don Davis. Provides a wealth of practical and theoretical information on the "whys" and "hows" of constructing top-quality speaker enclosures. Includes detailed drawings and instructions for building all basic types of enclosures. Explains advantages and disadvantages of each type; discusses speaker drivers, crossover networks. Written by two of the nation's leading acoustical engineers. 144 pages; 5 1/2 x 8 1/2". \$3.25 Order SEB-1, only.

### 101 Questions & Answers About Transistors

by Leo G. Sands. This unique book provides through a series of key questions and answers, a basic understanding of transistors, their theory and application. Covers: Transistor Characteristics; Audio Applications; Radio Applications; Oscillators; Control Applications. Fully illustrated. 112 pages; \$2.50 5 1/2 x 8 1/2". Order QTS-1, only.

### PHOTOFACT® Guide to TV Troubles. 2nd Ed.

by Howard W. Sams Editorial Staff. Over 200 photos of actual TV picture defects are keyed to specific defective components in typical circuits, so that the source of the trouble is located in minutes. Quick checks are outlined to help you determine rapidly which section is at fault. Includes recent TV models. 192 pages; 5 1/2 x 8 1/2". Order PFG-2, only \$3.95

### Short-Wave Listener's Guide. Enlarged 2nd Ed.

by H. Charles Woodruff. An essential book for short-wave fans. Lists all short-wave stations by country, city, call letters, frequency, power, and transmission time. Now includes stations in the newly recognized countries, along with Voice of America and Radio Free Europe stations. Also contains a listing of stations operating behind the Iron Curtain. Includes time conversion chart and handy log. 80 pages; \$1.75 5 1/2 x 8 1/2". Order SLG-2, only.

### Understanding Telemetry Circuits

by John D. Lenk. Telemetry is moving into industry and more and more technicians are required to service the newly developed systems. This book provides an excellent understanding of the four basic telemetry techniques currently in common use. Each of the techniques and its circuitry is explained in detail. 160 pages, 5 1/2 x 8 1/2". Order UTL-1, only \$3.25

### Electronics in Oceanography

by L. George Lawrence. Provides a comprehensive description of modern electronic systems used for gathering and interpreting oceanographic data. Chapters cover: Basic characteristics of oceanography; Measurement of salinity; Measurement of magnetism; Investigations of gravity; Electronic sound navigation ranging; Temperature measurements; Electronic pressure measurement; Measurement of light; Surface ranging and navigation; Electricity and marine animals; Submarines for Oceanography. 288 pages; 5 1/2 x 8 1/2". \$4.95 Order EOL-1, only.

## HOWARD W. SAMS & CO., INC.

Order from your Sams Distributor today, or mail to Howard W. Sams & Co., Inc., Dept. RE-1 4300 W. 62nd Street, Indianapolis, Ind. 46268

Send me the following books:

- ICB-1  QTS-1  SLG-2  EOL-1  
 SEB-1  PFG-2  UTL-1

Send FREE Sams Booklist. \$\_\_\_\_\_ enclosed

Name \_\_\_\_\_

Address \_\_\_\_\_

City \_\_\_\_\_ State \_\_\_\_\_ Zip \_\_\_\_\_

My Distributor is \_\_\_\_\_

# SERVICE CLINIC

By JACK DARR Service Editor

## In the Shop . . . With Jack

WE'VE HAD BOOST VOLTAGE FOR A LONG time, and in spite of an incautious statement by a certain Clinic Conductor a while back, it is even used in some transistor TV sets, as a cheap source of higher voltage for certain applications. It's easy enough to get boost—simply charge a capacitor with the energy from the flyback pulse during retrace time. If we return this capacitor's negative terminal to B+ instead of ground, the capacitor-stored voltage is added to the B supply. This means we've boosted the B+ voltage. Some schematics use the symbol B++ for boost.

However, the design engineers weren't content to leave the boost alone. They found they needed higher voltages, especially for some of the newer color CRT's. So, they boosted the boost and called it boosted-boost. In doing it, they simply repeated themselves (as I just did!) How? By using a tap on the flyback to provide a 500-volt pulse which is rectified and used to charge a capacitor. This capacitor is returned to B+, and its charge is added to the boost. The result of all this hanky-panky is a monster voltage called B+++.

Fig. 1 shows a basic RCA circuit, used in the CTC15 and CTC16 series, a good example of B+++.

The important point about boosted-boost circuits is that they use special rectifiers. Usually, such a rectifier is a very-high-voltage silicon unit, consisting of many tiny silicon-diode pills in series. If diodes are stacked in series, the voltage rating is multiplied by the number of diodes, while the current rating stays the same. A stack of ten 100-volt diodes would be good for 1,000 volts, and so on. The diodes are

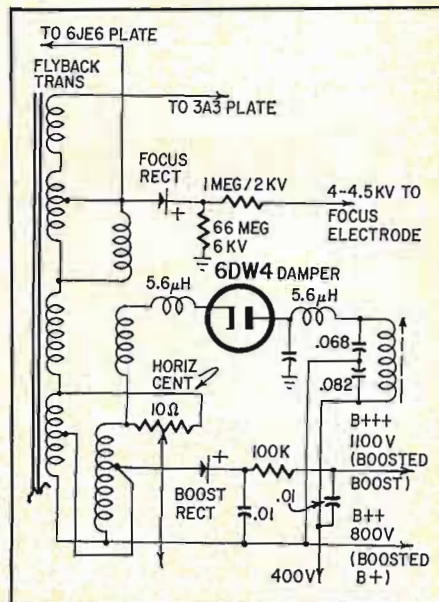

Fig. 1—Development of the boosted-boost.

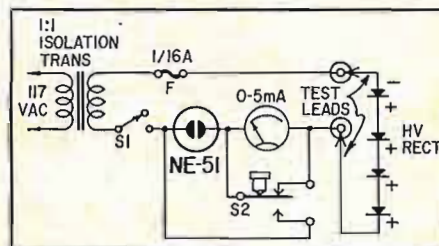

Fig. 2—One focus-rectifier test circuit.

usually packed in a long, thin tube, with axial leads.

The B+++ rectifier isn't so bad—it actually boosts the boost by only about 300–400 volts. However, the same type of rectifier is used to produce focus voltage, in the range of 3 to 5 kV or more. A typical focus rectifier might be about 2 1/2 inches long, and about half the size of a lead pencil, with a rating of 5.5 kV peak. It'll have about 9 jillion wee silicon diodes in it. The current rating of these focus rectifiers is down in the microampere range, since focus current is small.

The problem is testing the things. The average 1.5-volt ohmmeter battery won't tell you a heck of a lot about these diodes, since it won't cause enough forward bias to make them conduct. Even good diodes simply read open both ways, which tells us nothing. Focus voltage is low, but we don't know why—not yet.

General Electric has come up with a test circuit for focus rectifiers (Fig.

This column is for your service problems—TV, radio, audio or general and industrial electronics. We answer all questions individually by mail, free of charge, and the more interesting ones will be printed here.

If you're really stuck, write us. We'll do our best to help you. Don't forget to enclose a stamped, self-addressed envelope. Write: Service Editor, Radio-Electronics, 154 West 14th Street, New York 10011.



Some plain talk from Kodak about tape:

## The big squeeze—Multitrack Stereo

Remember the college fad a few years back—how many brawny brutes could be squeezed into a little car built for plain folks? For a while, it looked like a somewhat similar situation was about to take place in the tape-recording field—first monaural, then 2-track, then 4-track, and now even 8-track recording. Even though these developments continue at a fast clip, 4-track stereo is still the name of the game as far as high-fidelity applications are concerned. And very nice it sounds,

can record, you need a tape with a high-powered oxide layer—one that's going to give you a high output with a good signal-to-noise ratio. KODAK Sound Recording Tape, Type 34A, fills the bill—gives you 125% more undistorted output than conventional general-purpose tapes. You get practically the same per-channel output on 4-track stereo with Type 34A that the other tapes would give you on 2-track! But there's more to recommend the use of Kodak tape.

the other way. Horrors! Lucky for you, you have nothing to worry about with Kodak tapes. We keep our tolerance to .001 inches. That's twice as close as industry standards. To make your life even easier, we also backprint all our tapes so you can always tell

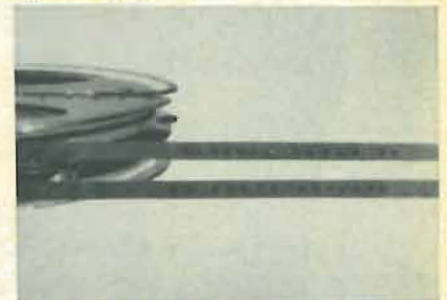

whether a reel has been wound "head" or "tail" first. Simply note which comes first off the supply reel, the "E" of "EASTMAN" or the "O" of "CO"... and note it on the reel.

Kodak tapes—on DUROL and Polyester Bases—are available at most electronic, camera, and department stores. To get the most out of your tape system, send for free, 24-page "Plain Talk" booklet which covers the major aspects of tape performance.

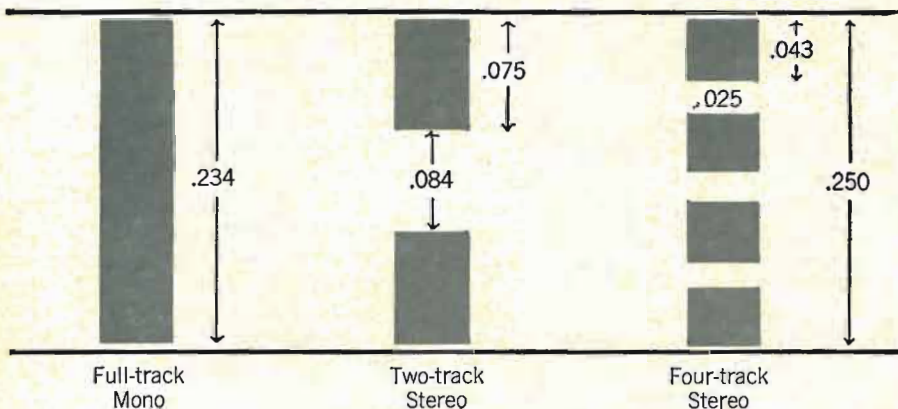

too, thanks to the precision built into modern heads. But you do have to watch yourself. Having double the information on a given length of tape means everything has to be just so—including the tape you use.

**4-track star.** The first thing to worry about in considering a tape for 4-track stereo is output. As you can see in the chart above, adequate separation must be maintained between each track to prevent cross-talk. And as the actual width of the recorded tracks drops down, the output per channel on the tape drops in proportion.

Thus, to make the most of what you

### Staying on the right track.

Because everything gets smaller in proportion when you go to 4-track, dimensional precision becomes that much more important. Take a tape that suffers from a case of drunken slitting. (That's when the edges of the tape snake back and forth even though the width is constant.) It's not hard to see how this tape isn't going to "track" straight past the head. A slight case of this and you get alternating fluctuations in output on both channels. If the condition is bad enough, a poorly slit tape can cause your heads to drop out the signals completely, even pick up the signals on the tracks going



EASTMAN KODAK COMPANY, Rochester, N.Y.

Circle 20 on reader's service card



# Eliminate confusion duplication waste



**STOCK AEROVOX COLOR  
CERTIFIED ELECTROLYTICS  
and be ready for every  
TV set you run across!**

Your customers will like the idea of a high quality "COLOR CERTIFIED" Aerovox Electrolytic replacement going into his set... and you will like the ease and convenience afforded by the New Aerovox Color TV Color Certified Electrolytic Capacitor Replacement Guide.

Get one of these guides FREE the next time you visit your Authorized Aerovox Distributor—and while you're at it, put in a supply of Aerovox COLOR CERTIFIED electrolytics to take care of your service needs... you just can't go wrong.

**AEROVOX**  
Hi-Q CORPORATION

DISTRIBUTOR DIVISION, New Bedford, Mass. 02741

Circle 21 on reader's service card

2). They apply the 117-volt ac line to the stack and measure current. You can do this without the isolation transformer, but watch out—the rectifiers will be hot with respect to ground. With this circuit, spring-loaded switch S2 shorts out the meter, until the neon bulb tells us that the rectifier is not shorted completely. (One of those "unlikely but always possible" things.) When the switch is pushed, the neon lamp is shorted, and the meter reads the dc output.

For focus rectifiers, a reading above 0.5 mA is considered good. Anything less should be viewed with suspicion. For B+++ rectifiers, which have lower voltage ratings but carry a higher current, the lowest reading should be 1 mA.

Motorola also has a test for B+++ rectifiers, as shown in Fig. 3. This uses a 45-volt battery or power supply, and a vtvm. The 1-meg resistor is used as a diode load, and keeps us from being fooled by rectifiers with too-high internal resistance. With the diode hooked up in the forward direction, the reading will be almost full supply voltage, and practically zero in the other direction.

If you have an ohmmeter with a very high resistance range, say X1 meg, it will give you an idea of the condition of these rectifiers. The bad one will probably read open in both directions. Good ones will read a pretty high resistance forward, but the back resistance should read infinity. This test isn't too reliable, due to the low voltage; the output-current test is better. Don't forget that you can always use the oldest test in the book—try a new part!

If the slide-rule jockeys keep bootstrapping their way up the boost-voltage scale, we might have some interesting problems a few years from now. You might hear something like this:

"Hey, Bill, what's the matter with that set?"

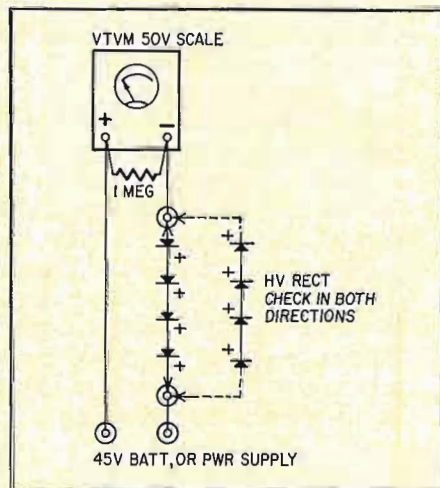

Fig. 3—Another way to test HV diodes.

"Don't know yet. My B+++ seems okay, but my B++++ is about 2,000 volts too low!"

## Color worms

I'm having trouble getting the color to tune properly, or hold, in a Zenith 29CJ20 color set. Good signal, all tubes check okay. If I tune into the "worms," I can hold color fairly well. But if I back up to get rid of the beat, color pops in and out. Tuner trouble, do you think? —K. W., Troy, N.Y.

Not necessarily. This is an alignment problem, in my experience. Try this: Tune for the best color, disregarding the worms. Check the setting of the traps—A5, A6 and A7—in the input of the video i.f. If one of these is even slightly off, it will cause your trouble. Watch the picture in the mirror, and very carefully move each trap, but not over a half-turn. If you're lucky, you won't have to make a full sweep alignment. The 39.75-MHz trap (A7) is the most critical.

## Automatic degaussers in metal cabinets

I'd like to install an automatic degausser, the kit made by Colman Electronics, in an RCA CTC11 color chassis. I note in your January 1965 issue that RCA uses auto-degaussing on all models except those in the metal cabinet. Is a degausser practical in a metal cabinet? —C. J., Los Angeles, Calif.

Yes. The only reason the auto-degausser was left out, as far as I know, is that the metal-cabinet model is the lowest-priced in the line. The degaussing circuit should certainly work just as well in metal cabinets as in wood, and they all use the same chassis.

## Intermittent red

In an RCA CTC15 color chassis, the red signal cuts on and off. I can tap the 6GU7 red amplifier tube and affect the red signal, but replacing the tube doesn't help. Sometimes, tapping the other (G-Y/B-Y) tube seems to have an affect. Any helpful ideas? —L. T., Provo, Utah

For one thing, I'd cross my fingers and check the picture tube. However, this sounds more like PC-board trouble. Take both demodulators out and clean the sockets very carefully, and make sure the contacts are tight. Then, resolder all contacts around both sockets, just for luck; this may cure the trouble.

In this chassis, by the way, red and blue are amplified in the same 6GU7 tube; green is handled by a section of the horizontal blanker tube. So, check the tube first, then all supply-voltage connections.

END



# Help stamp out green sky

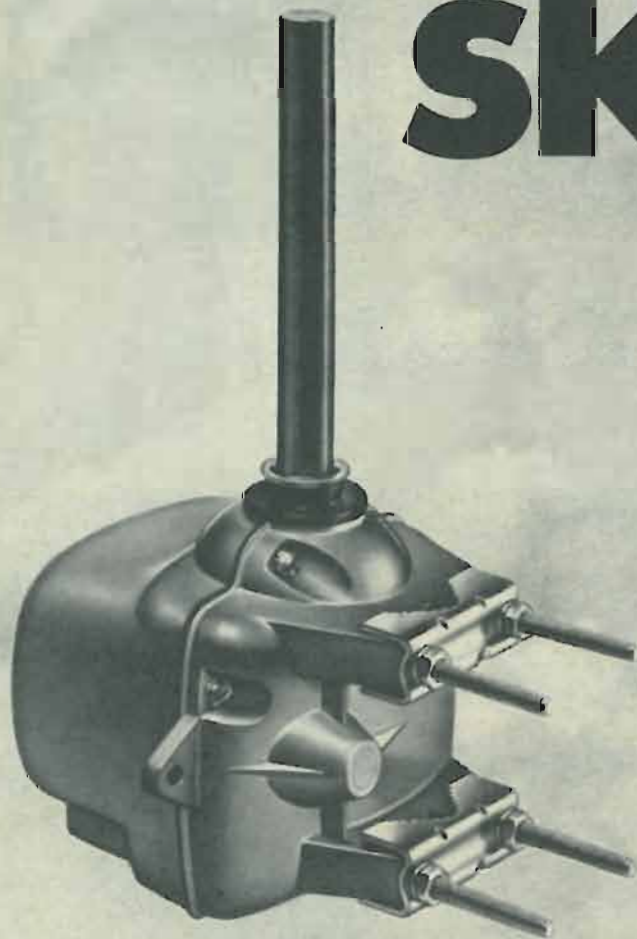

## CDE's Skyline Series Rotor Helps Give The Truest Urban/Suburban Color TV Reception!

Green sky, purple people and brown water...help your customers avoid these with CDE's Skyline series rotor. It's the most rugged lightweight on the market...the first rotor system designed specifically for metro-suburban areas.

It's *dependable*...because of a weatherproof die-cast housing. *Bet-*

*ter-performing*...because of a high-torque motor with heavy wormgear drive. *Longer-lasting*...because of heavier-than-average construction throughout.

And see the built-in antenna mounting mast? It's there to prevent mistakes: the Skyline series can *only* be fitted to antennas it can control.

Available in both automatic and manual forms, the Skyline series rotor means the very best in color and black and white TV reception. Goes great with FM rigs, too!

**CDE** **CORNELL-DUBILIER**





# We're looking for the men who want these well paid jobs!

And RCA Home Training can help you qualify  
Just mail card today for details



# Thousands of well paid jobs for men skilled in electronics are unfilled now

## RCA INSTITUTES CAN TRAIN YOU—AT HOME—AND HELP YOU QUALIFY FOR JOBS LIKE THESE!

Every Sunday—and most week days—you will find *The New York Times*, *The Houston Chronicle*, *The Los Angeles Times* and many, many other newspapers cram-full of ads like these. Actively seeking qualified men for jobs in electronics and related fields.

Many of the men who *could* qualify for these jobs—well paid jobs—that is, men with the aptitude and native interest to enjoy a career in electronics—are handicapped because for one reason or another they have not had the opportunity to train themselves for jobs like these.

## NOW—THANKS TO RCA INSTITUTES HOME STUDY—YOU CAN TRAIN FOR A CAREER IN ELECTRONICS

Realizing that thousands of technical jobs—well paid jobs—in electronics are or will be available, RCA Institutes has done something positive about the problem. To help sincerely interested men to get started toward a well-paid electronics job, RCA offers an ideal home training program!

## HOME STUDY CAN PROVIDE CAREER OPPORTUNITIES!

To help meet the need for qualified men in the electronics field, RCA Institutes has created a wide variety of Home Training Courses, all geared to a profitable, exciting electronics career in the shortest possible time. Included are exclusive "Career Programs" designed to train you quickly for the job you want! Your study program is supervised by RCA Institutes experts who work with you, help

guide you over any "rough spots" that may develop along the way.

## OFF TO A FLYING START WITH AMAZING RCA "AUTOTEXT" METHOD

Each "Career Program" starts with the amazing "AUTOTEXT" Programmed Instruction Method—the new, faster way that's almost automatic! "AUTOTEXT" helps even those who have had trouble with conventional learning methods in the past. It is truly the "Space Age" way to learn everything you need to know with the least amount of time and effort.

## RCA INSTITUTES ENGINEERED KITS SPEED YOUR PROGRESS

To speed you on your way to a successful electronics career, your "Career Program" will include a variety of RCA Institutes engineered kits at no extra cost—each complete in itself. As a bonus, you will also receive and build a valuable Oscilloscope. You'll get the new Programmed Electronics Breadboard for limitless experiments, including building a working signal generator and a fully transistorized superheterodyne AM receiver and Multimeter.

## CHOOSE YOUR CAREER PROGRAM NOW

To get started today on the electronics career of your choice, look over this list of RCA Institutes "Career Programs", pick the one that appeals most to you, and check it off on the attached card:

- Television Servicing
- Telecommunications
- FCC License Preparation
- Automation Electronics
- Automatic Controls
- Digital Techniques
- Industrial Electronics
- Nuclear Instrumentation
- Solid State Electronics
- Electronics Drafting

To meet other specific needs, RCA Institutes also offers a wide variety of separate courses which may be taken separately from the "Career Programs". Those range from Electronics Fundamentals to Computer Programming. They are described in the material you receive.

## ADVANCED TRAINING TOO

If you are already working in electronics or have some experience but want to move on up, you may start RCA Institutes training at an advanced level. No tedious repetition of work you already know!

## UNIQUE TUITION PLAN

With RCA Institutes, you learn *at your own pace*, and you pay only as you learn. There are no long term contracts to sign . . . no staggering down-payments to lose if you decide to stop . . . no badgering bills. You pay for lessons only as you order them, and should you decide to interrupt your training at any point, you may do so and not owe one cent.

## CLASSROOM TRAINING AVAILABLE

RCA Institutes Resident School is one of the largest schools of its kind in New York City with classroom and laboratory training available in day or evening sessions. Coeducational classes start four times a year. Just check "Classroom Training" on the attached card for more details.

## FREE PLACEMENT SERVICE, TOO!

In recent years, 9 out of 10 Resident School students who used the Free Placement Service have been placed before or shortly after graduation. This service is now available to Home Study students.

**SEND ATTACHED POSTAGE PAID CARD TODAY FOR COMPLETE INFORMATION. NO OBLIGATION FOR FREE BOOK AND DETAILS. NO SALESMAN WILL CALL.**

RCA INSTITUTES, Inc., Dept. ZRE-17  
350 West 4th Street,  
New York, N. Y. 10014



The Most Trusted Name in Electronics



# PURITY AND CONVERGENCE

**A penetrating study of the exact how's and why's of color-tube action from the point of view of two interrelated sweep-circuit functions**

**By W. D. MURPHY and R. L. CARR\***

MANY PEOPLE IN THE ELECTRONICS field—technicians, hams, engineers, hobbyists—know something of the operation, adjustment and repair of the color TV receiver. Most of these persons are fairly knowledgeable about front ends, i.f.'s, agc, sound section, sweep circuits, etc. But there is still confusion in the minds of some regarding the relationship between purity and convergence. Why? Perhaps because both purity and convergence assemblies are on the neck of the CRT, because both must be adjusted during setup, and because both appear to interact with one another.

Purity and convergence in a color receiver are like the sparkplugs and carburetor in a gasoline engine, in one important respect: Each is an example of A and B interaction. Sparkplugs and carburetors perform different jobs, but they are interrelated. The sparkplugs ignite the mixture of air and gasoline which the carburetor produces. If either is defective or misadjusted, the engine won't work properly. Fouled plugs may require carburetor adjustment to keep the engine running. Conversely, improper gas mixture (defective carburetor) may lead to poor sparkplug life.

In a color receiver, both purity and convergence are necessary for the CRT to display a proper picture. The two perform completely different jobs, but they are interrelated because each affects the picture on the screen.

## **Color-picture-tube construction**

You know, of course, how the three-gun tube works: Three electron beams excite red, blue and green phosphors on the screen by passing through holes in the shadow mask. Although all three beams may pass through the same hole, they do so at different angles, thus striking three phosphor dots of three different colors. Thus the color picture is formed. In order for each beam to hit its respective dot, the position of the

dots with respect to the holes in the shadow mask must be precisely established.

Fig. 1 shows how phosphor dots are put on the screen of a color CRT. First, the inner surface of the faceplate is covered with a mixture of single-color phosphor and light-sensitive "photoresist" material. Then the shadow mask is inserted into its precisely located mounting assembly within the faceplate (see insert). Next, the faceplate and shadow mask assembly is mounted on an "exposure" table (as shown). Finally, ultraviolet light is used to fix the phosphor dots to their permanent positions.

The ultraviolet (UV) lamp is placed under the faceplate at the position where the yoke will be when the CRT is in a receiver. A concentrator lens above the lamp forms the UV light into a point source. Further above, a corrector lens makes a small change in the angle of light striking the screen edges. (This is needed to correct for certain yoke characteristics which will be discussed later.)

As you can see in Fig. 1, only UV light which passes through the shadow-mask holes strikes the phosphor layer. Where this happens, the phosphor is hardened and secured to the faceplate. Since the UV light passes through every hole in the shadow mask, a dot of one color is formed for every shadow-mask hole. The unexposed phosphor is then washed away, and the process is repeated for the two other colors. Each time the phosphor color is changed, the point source and lens system are repositioned, to correspond with the position of each electron gun in the finished tube. Since the UV light passes through the shadow mask at a different angle for each of the three colors, the sets of colored dots are positioned differently on the faceplate.

After the faceplate has been sealed to the CRT envelope, the three electron guns are precisely placed within the neck of the tube. This insures that the three electron beams will start from the exact points at which the UV light was

located when forming the color dots.

## **Purity**

The process we've described is reversed when the color CRT is installed in a receiver and displays a picture. The electron guns emit beams which excite the phosphor dots; the dots, in turn, emit colored light visible to the viewer's eye.

Sometimes, when the color picture isn't correct, we say the purity is at fault. What do we mean? A simple definition of purity is: Nothing but red on the screen when only the red gun is turned on, and the same for the green or the blue guns.

Each electron gun (a point source) in a color CRT is installed in the same place the UV light (also a point source) was, with respect to the screen. Then, when the red gun is turned on, for instance, it lights red dots. This is true *only* because the "red" electrons pass through the shadow-mask holes at "red" angles. If the red gun is aimed correctly, the red electrons go through the shadow mask at the wrong angle and hit the wrong phosphor dots. This causes impurity.

The color picture tube forms a picture line by line and dot by dot with the point-source electron beam. It is fairly easy to align the gun so the beam produces correct purity at screen center. But—what about at the edges of the picture?

Fig. 2 shows how the deflection yoke bends the electron beam to cover the sides and edges of the picture. From the faceplate's point of view, it appears as if the deflected beam had actually originated from a point within the yoke itself. The location of this *apparent deflection point* is determined by the yoke. Fig. 2 also illustrates that the deflection point is actually shifted *by the yoke* along the tube axis as the angle of deflection changes. This is a characteristic of the yoke. Near the edges of the screen, where the deflection angle is greatest, this point is much closer to the faceplate. If there were no corrections built into the tube to compensate for the yoke, it would be impossible to achieve overall purity. The exposure table of Fig. 1 has a large correction lens between the UV lamp and the faceplate. This correction lens is designed to match typical yoke characteristics, since the length, winding shape, field uniformity, etc. deter-

\*Sylvania Electric Products, Inc.



# INTERACTION

mine how the electron beams will bend when they pass through the yoke.

In addition to the yoke, one other component controls purity. That is the rotatable, adjustable-strength *purity magnet* on the neck of the picture tube. Precise gun alignment during manufacture isn't always possible, and the purity magnet is used to fine-align the guns.

An important, but often overlooked, function of the purity magnet is to compensate for the effects of the earth's magnetic field. This field bends the electron-beam paths, causing impurity. The amount of this impurity depends on where the receiver is and how much iron or steel is near it.

Alignment instructions for a color receiver usually state that the purity magnet should be adjusted to obtain good center-screen purity only, with the yoke deliberately moved back toward the convergence assembly. This procedure should be followed so that, for the initial purity adjustment, the *only* possible area of the screen capable of correct purity is the very center. Then the purity magnet is adjusted so the electron beam is properly aimed for screen center.

Purity adjustments are usually made with only the red gun operating, since a red screen shows up impurities more glaringly than a blue or green screen. Once the red beam has been properly positioned, the other two will normally be correct. Should there be small errors in gun alignment, the purity magnet and yoke can be used for compromise purity of all three fields. Moreover, since any slight impurity will be *most* noticeable on a black-and-white picture, the compromise adjustments are made to produce a pure "white field" at the expense of any minor impurity in the individual colors.

Those who have worked with color receivers know that stray magnetic fields—whether caused by the earth, or a nearby coil or magnet—can affect purity. For example, the shadow mask is made of steel. If it becomes magnetized, the resultant field will change the electron-beam angle, producing impurity. A degaussing coil prevents this impurity by removing any stray magnetism from the chassis and cabinet. Every time a receiver is moved, it's remagnetized by the earth. This causes impurity. *For this reason, purity adjustments must*

*be made with the receiver in its final viewing position.*

Recent receivers incorporate automatic degaussing circuits; whenever the power is turned on, the CRT is degaussed. Such sets, when properly set up, *may* be moved without earth-field impurity. But, whether automatically or manually, always degauss the set before you make any purity adjustments. If you don't, you may find an "improper" setting of the purity magnet and yoke that will cause what seems to be an acceptable picture. Then, when the set is degaussed (automatically or manually), the purity will be incorrect.

## Convergence

While purity is a static function only, convergence contains both static and dynamic elements. Time is no factor in purity, since it doesn't matter when a particular phosphor dot is excited. Once correct purity adjustments have been made, they will be correct no matter how slow or fast the beams are traveling when they hit the phosphors.

The same is not true of convergence. Fig. 3 shows two spotlights on a table aimed at a screen. Each spotlight

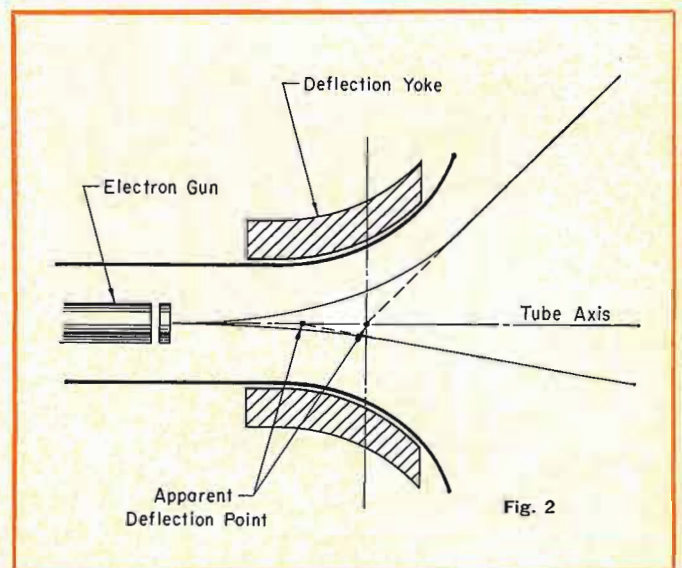
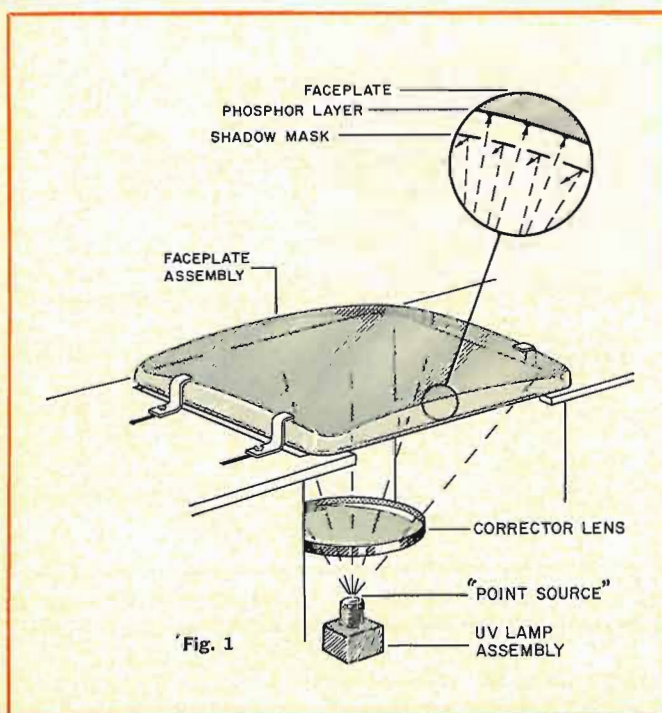

Fig. 2—One thing necessary for purity—apparent deflection point of beam must be shifted to compensate for flat faceplate.

Fig. 1—Beginning of a color picture tube. The colored phosphor dots are deposited on the faceplate with ultraviolet light.



is fitted with a color filter—one red, one green. When the spotlights point at screen center, their beams converge into a single yellow spot. When the table is turned slightly to the right sometime later, the beams *overconverge* (shown by dashed lines) and form separate spots of red and green on the screen. Why? The distance from the table to the edge of the screen is greater than the distance from the table to screen center. Notice that the respective positions of the lamps on the table hasn't changed—only the direction the table points (a function of time). The only way to make the lights converge at the edge of the screen now is to change their mounting positions on the table.

The electron guns and beams in a tricolor picture tube operate much like the spotlights of Fig. 3. First, convergence adjustments cause the beams to converge at screen center. When the yoke deflects the beams—as the spotlight table was turned—the beams do not converge (hit the correct dots) simultaneously at the edge of the screen. During any time interval that a color CRT is being operated, its beams are being deflected by the yoke. As the respective positions of the spotlights had to be changed to converge their beams, so the electron-beam deflection angles have to be changed in the CRT so they strike the correct landing spots. Thus time is a factor in convergence.

Fig. 4 illustrates convergence and misconvergence in the color picture tube. Each electron gun is tilted toward the tube's center axis so the beams converge precisely at screen center. Convergence at other parts of the screen is made with respect to the center. In an

actual tube, gun tilt is approximately  $1^\circ$ . (In Fig. 4, gun tilt is exaggerated for clarity.)

Magnets are used for fine adjustment of the point where the beams hit the screen. They compensate for any slight errors in mechanical positioning of the guns during picture-tube manufacture. By proper adjustment, the two beams illustrated (red and green) will converge into one point of yellow light at screen center.

Now observe, in Fig. 4, what happens at the edge of the screen. Both beams are deflected the same amount ( $30^\circ$ ) by the deflection yoke. Since both guns are pointed toward screen center at an angle off the tube axis, each beam is deflected off the center axis by a different amount. The beams also travel farther to the edge than they did to the center. Since the beams converged at screen center on the shadow mask, but now must travel further to the edge of the screen, they now converge before reaching the mask. Thus the beams fall on the screen as two individual spots of light.

The dots in Fig. 5 represent beam-landing points before correction. The arrow on each dot shows the direction in which the beam must be moved to converge that particular portion of the screen. Since all three beams are already converged at the center of the screen, corrections are started there. Note that every blue arrow points upward, every red arrow points to the lower left, and every green arrow points to the lower right. This means that, whatever portion of the screen is being converged, the direction of each beam travel is always the same. The arrows are of

different lengths however, showing that different amounts of correction may be required at various screen locations.

### Convergence circuits

Suppose the gun tilt shown in Fig. 4 was adjustable from  $4^\circ$  to  $7^\circ$ . Then, regardless of yoke deflection, we could slightly adjust the deflection angle of each beam. The overall deflection would then be the vector sum of the yoke deflection plus the beam tilt. The dynamic-convergence assembly of the actual picture tube does just that—not mechanically of course, but by magnetically tilting the path of the electron beams. The currents in the convergence coils are adjusted by electronic means to reduce the tilt to something less than the angle set by the gun positioning.

Remember, all beam corrections are applied in a direction *away* from the center of the CRT, since the tendency is to overconvergence, or crossing before they reach the screen. As misconvergence varies with beam position over the screen, it is a dynamic or changing characteristic of the tube. Any corrections must also be dynamic. (As we pointed out earlier, time is a factor in convergence action.)

In a color receiver, the horizontal and vertical deflection circuits provide power to operate the convergence circuits in step with the horizontal and vertical scanning. The basic correction applied is a parabolic (bowed) waveform. This wave goes to zero at the center of each cycle, and has a peak at both beginning and end of the deflection period. Since convergence correction for a particular beam is always in the same direction and at screen edges, the two peaks

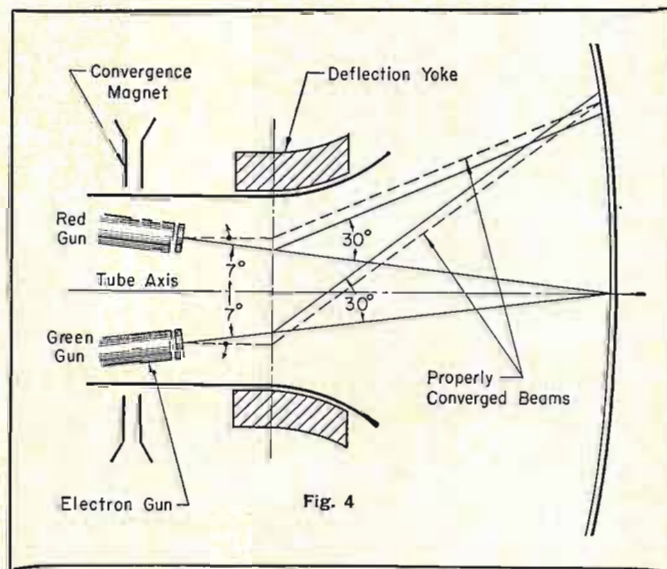
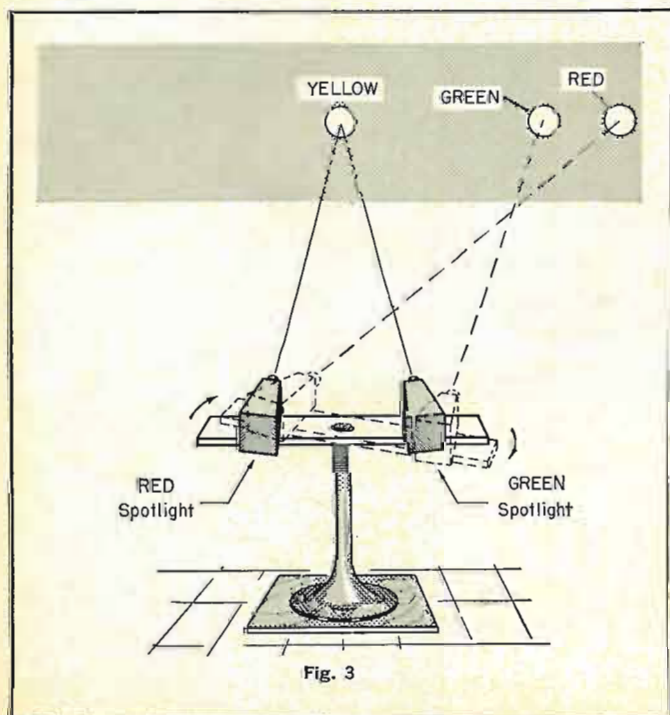

Fig. 4—The amount of dynamic convergence needed depends on where the beams are on the screen at any given moment.

Fig. 3—Spotlights simulate action of electron beams in color CRT, showing why convergence correction is necessary



of the parabolic waveform will deflect the beam in the required direction.

As Fig. 5 shows, different amounts of deflection are required for a specific beam from top to bottom and left to right, but the correction is applied in the same direction. No dynamic convergence is required at screen center—the zero point of the parabolic wave. The convergence circuits in a receiver modify the basic parabolic waveshape so the two peaks can be adjusted to different amplitudes.

Many receiver setup manuals state: Make all vertical convergence adjustments on a vertical line through the center of the screen; ignore any errors appearing on either the left or right side.

Why such a procedure? No horizontal deflection is applied to any of the beams anywhere along this vertical center line. The three beams are mechanically converged by gun tilt (and static convergence magnets) in the center. The *only* misconvergence that can occur along this vertical line is due to vertical deflection of the beams. A similar method is used for horizontal convergence. Thus, the two components of convergence error—horizontal and vertical—can be separated for ease of viewing during adjustment.

Corner convergence is more complex. The beams land, in a corner, at a point determined by the *vector* sum of the horizontal and vertical distance from each gun to the screen. That is, there is both a *horizontal* angle and a *vertical* angle which determines the point where each beam lands. However, convergence correction is applied by only one magnetic field, which is the *simple* sum of the horizontal and vertical convergence corrections.

A very complex circuit—expensive to build and difficult to adjust—would be needed to obtain *perfect* convergence over the entire screen. Such a circuit is not used in color receivers. Thus, there is normally slight misconvergence in the corners when the horizontal and vertical axes are perfectly adjusted. In addition, it may not be possible to adjust the circuit for the precise waveform needed to converge a specific yoke-and-picture-tube combination at some small area of the screen. In practice, therefore, convergence must be made for the best overall compromise.

The static convergence magnets have two important jobs: To correct for any mechanical misalignment in the tube, and, as a part of the dynamic convergence circuit, to offset the effect of ac coupling on the convergence signals.

These magnets correct any slight mechanical misalignment of gun tilt (as pointed out previously). They also offset any slight dynamic convergence voltage that exists at the center of the screen.

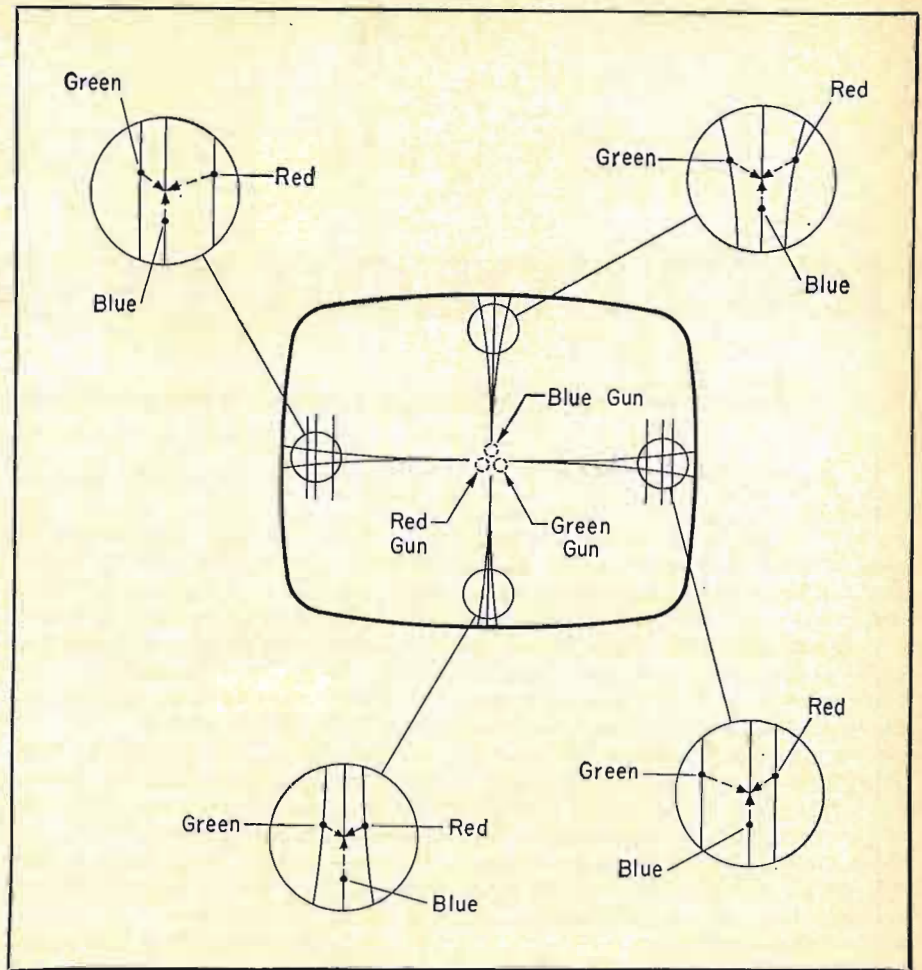

Fig. 5—The dynamic convergence signal is a parabolic wave. It applies zero correction when the beams scan screen center. More is used as the beam approaches the edges.

Remember that zero dynamic convergence signal is required at screen center, but since the various convergence voltages are ac-coupled, they will go both positive and negative from zero. This means if the beam is shifted to the right at the edge of the screen, it will be shifted to the left at the screen center. The static magnet is used to buck out the effect of this negative (or unwanted) dynamic convergence at the center.

There is one other convergence control—the blue lateral magnet. A static control, it is used primarily to correct for slight gun misalignment by shifting the blue beam horizontally to intersect the converged red and green beams. (Some receivers, however, use a dynamic control to improve overall convergence.)

There is an additional point—sometimes overlooked—which we haven't covered. Static convergence should be adjusted reasonably close before making any purity adjustments. It doesn't matter if the three fields are impure when making this adjustment; the important thing is to converge the beams.

Interaction of dynamic convergence circuits with purity has been mini-

mized by the tube manufacturers. The dynamic convergence signal reduces the 1° beam tilt to achieve convergence, and also shifts the beam away from the "point source." As mentioned so often, any point shift causes impurity.

The lens system in the exposure table that's used in screen manufacture is designed to correct for this interaction. The apparent "point source" for the edges of the screen is shifted to coincide with the shifted beam caused by the convergence signals. Therefore, when the correct amount of convergence is applied to the edges of the screen, the now "shifted" electron beam will pass through an also "shifted" point source.

In summary, purity and convergence are separate factors in the operation of a color picture tube. Like spark-plugs and the carburetor in a gasoline engine, though separate, they are inter-related because they work on a common third element—the release of energy from gasoline, or the display of a picture on a color CRT. Just as carburetor misadjustment can cause poor spark-plug performance, misadjustment of the convergence circuits can cause poor purity. END



# 1967 COLOR-TV ROUNDUP

Refinements and innovations appear in new crop of multihue receivers

By WAYNE LEMONS

THERE IS NO QUESTION THAT MORE color TV receivers will be sold and serviced in 1967 than ever before. More manufacturers are making sets and many are introducing additional models.

Color, much like b-w some 10 or 12 years ago, is in a state of change and consequently has some growing pains. Designers are pressing toward that ever-elusive "standard" circuit by widely varying routes. Transistors, which started trickling into color design a couple of years ago, now are spreading into all color circuits. Not even power stages will remain sacred to the vacuum tube for long. This year several brands use an audio-output transistor.

Color TV designers, who once took all their cues from RCA, no longer worship at the shrine and have started condensing, refining and even revolutionizing their circuits. Composite color oscillator-demodulators such as Motorola's, Zenith's gated-beam demodulator, and G-E's diode color demodulator, today employ fewer tubes, but without a sacrifice of good engineering practices. For example, the G-E color circuit uses only three tube envelopes in the entire color

section and one of these is a video amplifier!

In 1967 designs, many tube functions have been taken over by transistors and IC's (integrated circuits). Philco, for instance, has nine transistors in a single color chassis, including three in one of the first solid-state color tuners. RCA is using an IC in the sound section of the CTC21 chassis.

Because of this scramble to solid-state circuitry in new color sets, most of this survey will concern the uses, functions and service problems of the new solid-state designs. First, however, let's look at the more-or-less mechanical aspects of the new sets.

The "Blue Wide-Field Correction" used by RCA and others is just such a mechanical innovation. One of the frustrations that all of us have had, especially with rectangular color CRT's, is that often the blue vertical lines (using cross-hatch) were to the left of the red and green lines on the left-hand side of the screen and to the right on the right-hand side. In other words, the blue field was wider than the others. On all but a few receivers (chiefly Motorola) there was no adjustment to compensate for this

defect. It was an annoyance to both the technician and to the critical customer.

The side-blue problem occurs because the blue gun is closer to the right-angle field of the deflection yoke than either the red or green gun and thus has slightly more scan sensitivity. The Blue Wide adjustment used by RCA minimizes or eliminates the defect by allowing for some up-and-down movement of the deflection yoke, which can be adjusted by a screw at the bottom of the yoke housing (Fig. 1). By careful positioning of the yoke, the blue-field sensitivity can be made comparable to the red and green fields. (This is a factory adjustment and will seldom need to be changed.)

Other mechanical features you'll be seeing more of will be the combination blue-lateral and purity-magnet assembly. And you'll be seeing more dc-magnet assemblies that will not fall out of adjustment so easily when the set is transported. For example, the wheel-type magnets in Fig. 2 are representative of those used by Admiral, Magnavox, Zenith and others.

Post-purity adjustment (purity rings in front of the deflection yoke), used by Zenith for a couple of years, has bit the dust. The reason is probably an economic one, not to mention the

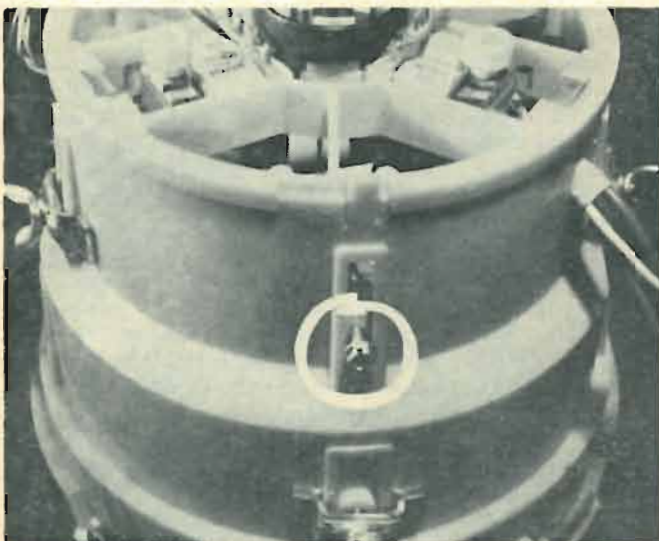

Fig. 1—Circled screw is blue-wide adjustment on RCA models.

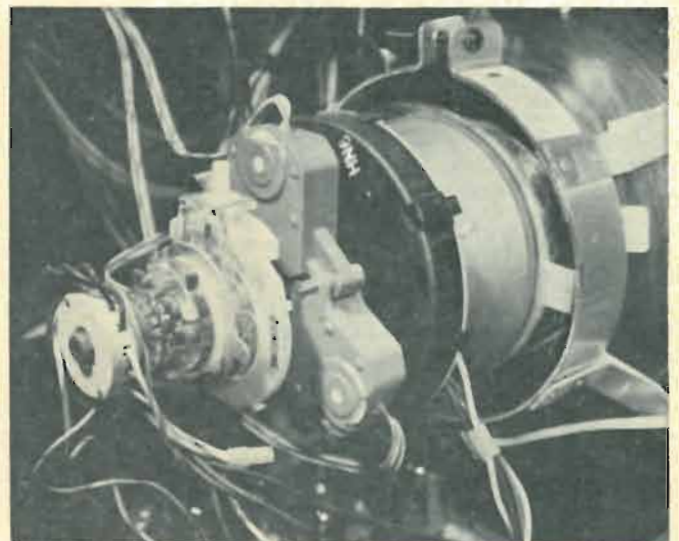

Fig. 2—Some sets use new wheel-type magnets near CRT base.



fact that post-purity-ring adjustment always required a CRT degaussing afterward.

For the first time this year, many manufacturers have taken more than a passing interest in seeing that their color sets are, or will be, properly tuned by the customer. Although Magnavox has had tuner afc for a while and Motorola has had a color indicator lamp, this year RCA has added tuner afc. Philco has a tuning eye and G-E a tuning meter that permits the customer almost-perfect assurance that the set is tuned correctly to receive the best color or black-and-white picture and sound.

Pincushion adjustment is still done by tubes, transistors, saturable reactors or some combination of the three. Some manufacturers use little or no horizontal correction but all have simple-to-elaborate means of vertical correction. Motorola has added a transistor circuit for horizontal correction this year, to go with its already transistorized vertical pincushion circuit (Fig. 3).

A lot of manufacturers are turning out color receivers with 19-inch screens, and in most cases the 19-inch chassis is identical to the same manufacturer's 23- or 25-inch chassis. The only really portable color is probably still the 11-inch Porta-Color made by G-E. This chassis with its small CRT has provisions only for dc convergence and very minimal dynamic-convergence adjustments.

### New controls

Additional controls have been added by some set makers to simplify setup procedure. RCA, for the first time this year, has made its setup switch a three-position unit. (It isn't, however, the first to do this.) They have labeled the switch NORMAL—SERVICE—RASTER. The NORMAL and SERVICE positions are the same as before, but the RASTER position is what Westinghouse and others have called a PURITY position. This position is useful when adjusting purity or setting gray scale, since it provides a snowfree raster without having to pull an i.f. tube. (Many technicians connect a dot/bar generator to produce dots and then simply disregard the dots when adjusting for best purity.)

Some of this year's RCA models contain another new switch (Fig. 4), a RED/GREEN control switch. This function allows the red- and green-signal outputs to be switched between the CRT's red and green cathodes. Such

switching can be useful if the red phosphor of a particular CRT happens to be more efficient than its green—a situation that might often arise when installing a replacement CRT.

Motorola's TS918 chassis, which is essentially the same as its earlier TS914 (except for the horizontal pincushion correction already mentioned), now includes a pair of switches on the convergence board. The switches reverse the phase of vertical-tilt voltages, when necessary, to get better convergence. Such phase reversal was done on the TS914 with plug connectors.

The BLUE SHAPE coil used on the convergence board of some 25-inch receivers has been made nonadjustable by some manufacturers. This step was taken because the coil is not a part of the convergence procedure and its misadjustment can overload the horizontal sweep circuit.

### High-voltage regulation

The 6BK4 shunt regulator was pretty much of a standard in this stage until a year or so ago, when Motorola introduced its diode feedback control. Now the circuit has been given another look (Fig. 5) by Zenith designers. They use a new regulator tube (6HS5) in a low-impedance circuit—across the damper instead of from high voltage to B+. Essentially, the regulator samples boost voltage and loads the damper circuit to the extent required to maintain a constant load on the horizontal sweep system. A VDR (voltage-dependent resistor) in the 6HS5 grid circuit tends to "amplify" larger voltage changes while acting as a normal resistor during lesser changes. This arrangement gives better HV regulation for changes in load.

Silvertone uses a VDR, as does Philco, to provide voltage regulation at the grid of the horizontal output tube

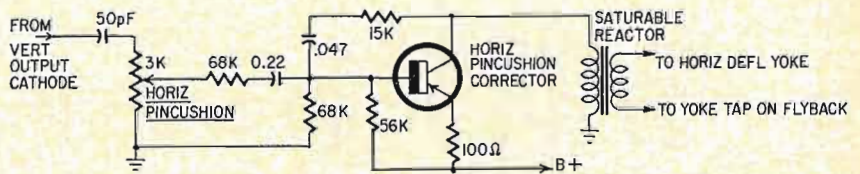

Fig. 3—Motorola TS918 receiver uses pincushion correctors for both horizontal and vertical deflection.

Fig. 4—Gun-drive switch on RCA CTC21 allows compensation for lack of phosphor efficiency in CRT.

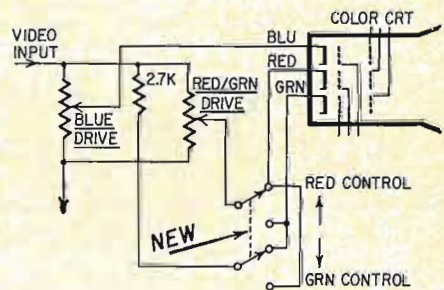
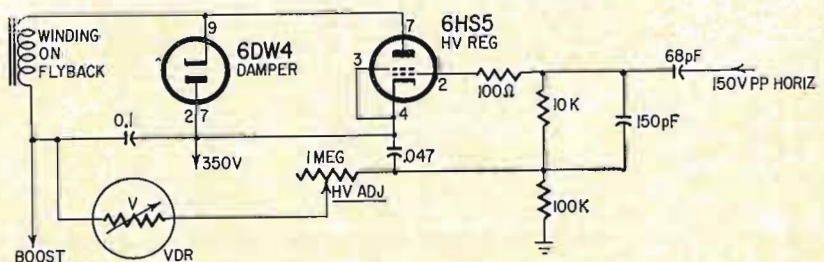

Fig. 5—Unusual power tetrode is used across damper in Zenith 23X chassis for HV regulation.





(Fig. 6). The principle and effect are similar to Motorola's circuit. A feedback loop is established, containing a variable control element (the VDR) which holds horizontal sweep voltage constant. Since

flyback input voltage is constant, flyback output (HV) is also constant.

The circuit used by G-E and shown in Fig. 7 at first appears to be a diode regulator. It is actually called a "hold-

down" circuit by G-E. It works like this: If the high-voltage shunt-regulator tube should burn out, most of the HV circuit load would be gone. With a small load, the high voltage would soar, along with all horizontal-sweep voltages, causing breakdowns and HV arc-overs. The silicon hold-down diode prevents this condition by conducting more current when flyback pulse voltages increase. This higher conduction develops a more negative grid potential at the output tube. In a sense, the diode is a sort of standby or safety HV regulator.

### Other circuits

The transistor and the IC (integrated circuit) are moving quickly and steadily into color circuit design, as we noted earlier. Although these devices may at first cause consternation to service technicians, they promise to be a boon to serious technicians. Do-it-yourself tube jockeys will find IC's and solid-state devices mighty baffling.

Transistors first appeared in TV at the video stage in b-w receivers. The same is now true for color, where some manufacturers use at least one transistor to drive the luminance channel. The low impedance of the transistor is ideal for matching to the delay line. Some even use two transistors in cascade, to provide more gain ahead of the delay line. This permits the designer to use a lower- $G_m$  video-output tube, and such tubes usually cause fewer service headaches.

In G-E's "KC" chassis this year, the video circuit (Fig. 8) uses two npn transistors. Bias for the first stage is unconventionally derived from the power-transformer filament winding, rectified by D1, and filtered by R1, C1 and C2. It's quite similar to applying fixed bias to the cathode of a vacuum tube. No base bleeder resistor is needed, and the bias voltage is fairly stable.

The circuit of Fig. 9—from an RCA CTC 21—is, to our knowledge, the first in a color set to use a transistor audio-output stage. The unit is a special high-voltage transistor with 160 volts on the collector, and it is protected against overloads in two ways. A 60-mA fuse is in series with the collector, to guard against excessive current as well as leakage. To place a limit on collector voltage, a reverse-biased diode is connected between the collector lead and the 270-volt line. Collector voltage therefore cannot exceed 270, for above this limit the diode conducts, clamping the collector voltage at 270. In servicing this circuit, note that if the fuse opens, the

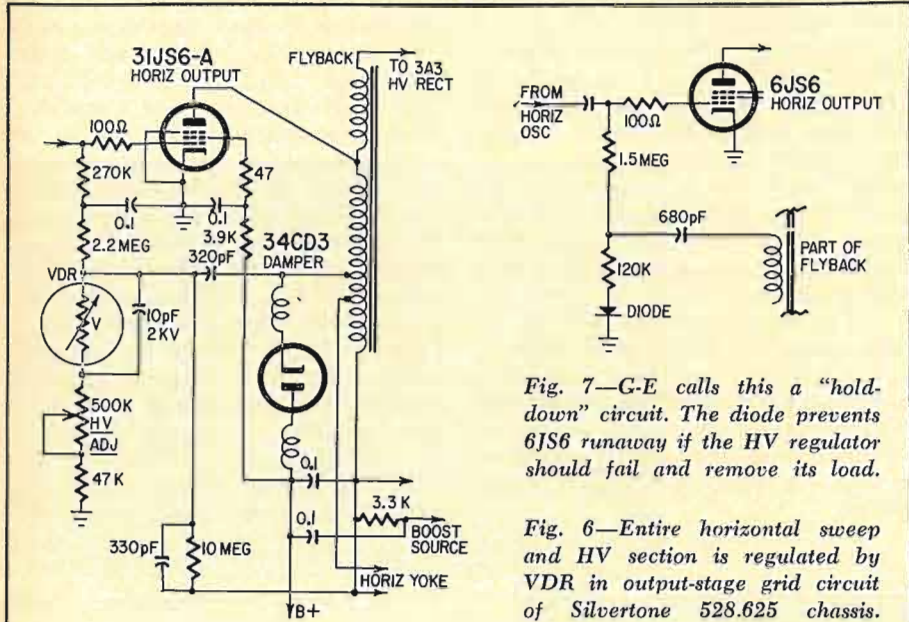

Fig. 7—G-E calls this a "hold-down" circuit. The diode prevents 6JS6 runaway if the HV regulator should fail and remove its load.

Fig. 6—Entire horizontal sweep and HV section is regulated by VDR in output-stage grid circuit of Silvertone 528.625 chassis.

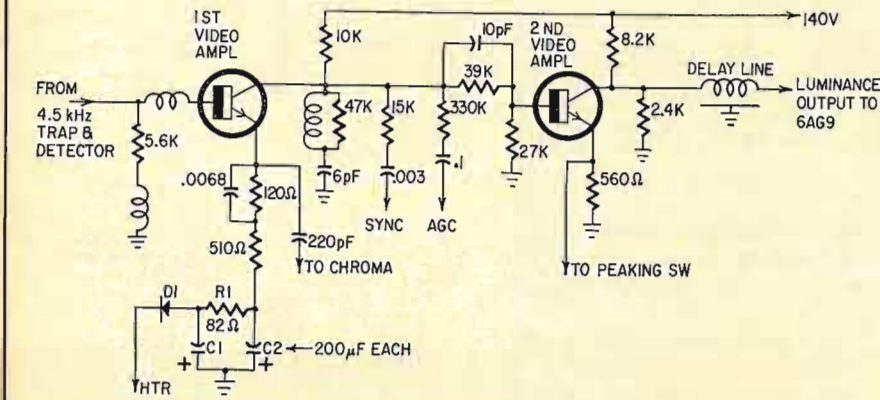

Fig. 8—G-E KC series video circuit obtains transistor bias from heater winding.

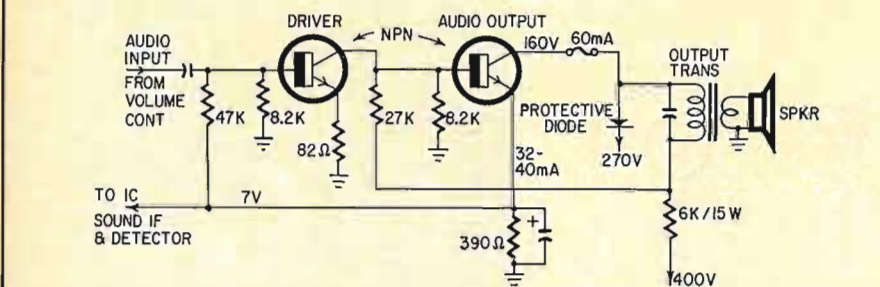

Fig. 9—Audio section of RCA CTC21 uses special high-voltage transistors.







tuned to peak the meter reading or close the eye tube when the picture and sound are properly tuned in. Thereafter, the user fine-tunes for maximum indicator reading.

The tuner afc circuits are more complex. Fig. 14, from an RCA CTC21, uses a transistor amplifier (Q1) for the 45.75-MHz picture carrier. Q1 is followed by a Foster-Seeley discriminator and Q2, a dc amplifier, which furnishes correction voltage for the tuner. An input trap (see diagram) restricts the pull-in range so that the circuit will not attempt to lock in (or out) on any false signals.

An unusual feature of this circuit

(Fig. 15) is the use of a transistor as a diode for the controlling element. (Notice the emitter is not connected.) Q3 essentially acts as a variable resistance, causing the 5-pF capacitors to have a greater or lesser effect on oscillator tuning. (The uhf tuner uses a variable-capacitance diode and no reference voltage.)

RCA suggests that the fine tuning be adjusted so that the picture just starts into sound bars. (The afc defeat switch is automatically closed when the fine tuning is being set manually.) Then, when the defeat switch opens, the afc will bring the picture and sound in at the right point.

### Variable-capacitance diode

A Varicap is being used this year by G-E in the hue-control circuit shown in Fig. 16. Although not new (Packard Bell has used the principle for several years in a conventional burst-amplifier circuit) it is different. The 3.58-MHz crystal is "brute-forced" into ringing, rather than being made to oscillate in the accepted sense. This ringing is made to occur at the right phase by the injection of strong pulses of burst information. The varying capacitance load on the crystal circuit causes it to change phase enough to provide control over hue.

### Series-diode blanker

Fig. 17 shows one of the first series-diode blanker circuits we've run across. In this circuit, all video information passes through the diode because of the forward bias placed on it by the 390K resistor to B+. During retrace, however, a vertical pulse through the 15K resistor "opens" the diode (and its low-impedance path to ground) so that a strong negative pulse is applied to the grid of the second amplifier. This pulse is then amplified and inverted by the second video stage, producing a strong positive pulse at the CRT cathodes and eliminating retrace lines.

### Integrated circuits

To my knowledge, only RCA is using IC chips in its color sets. The circuit used in the CTC21 is shown in Fig. 18 as it appears in the schematic. (Note that each IC's internal circuitry is *not* shown.) When troubleshooting, you'll have to use exact replacement IC's. [For the complete schematic of these IC's, see "The IC Comes to TV," page 27, RADIO-ELECTRONICS, June 1966.—Editor]

### Summary

Color TV is going to be big in 1967. Technicians, of course, cannot ignore the fact that they must learn new servicing techniques to deal with new solid-state circuitry. The all-transistor color set can't be too far away and the time to learn its techniques is during the transition. Essentially the change in technique won't be as drastic as you might think—but neither will it be as minimal as you might hope. It's a time for all of us to roll up our sleeves, attend service meetings, digest magazine articles and books, and look forward to a really bright and colorful future.

END

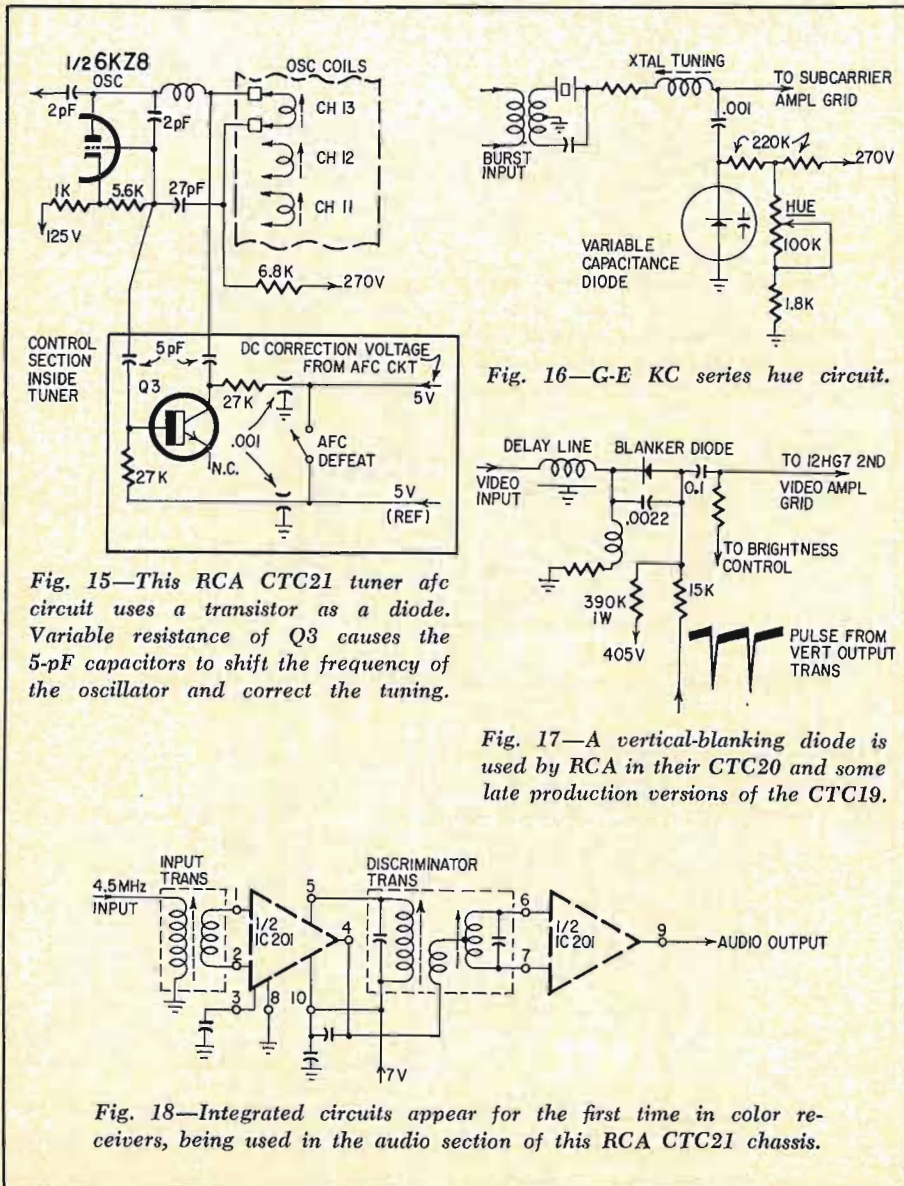

Fig. 15—This RCA CTC21 tuner afc circuit uses a transistor as a diode. Variable resistance of Q3 causes the 5-pF capacitors to shift the frequency of the oscillator and correct the tuning.

Fig. 16—G-E KC series hue circuit.

Fig. 17—A vertical-blanking diode is used by RCA in their CTC20 and some late production versions of the CTC19.

Fig. 18—Integrated circuits appear for the first time in color receivers, being used in the audio section of this RCA CTC21 chassis.



# What Happened at Oslo?

Why there isn't worldwide agreement on a color-television system

By THOMAS R. HASKETT

PREVIOUS RADIO-ELECTRONICS ARTICLES have discussed color television as proposed throughout the world.\* This subject was one of several considered by participants in a conference at Oslo, Norway, during June and July 1966. To find out exactly what was discussed, why it was discussed, and why the conference ended the way it did (RADIO-ELECTRONICS, October 1966, p. 4), we interviewed two US delegates.

Dr. George H. Brown is executive vice president, research and engineering, of the Radio Corporation of America. Long a radio and television engineer, he is the developer of the *turnstile* antenna, the most widely used television transmitting antenna.

Mr. Frederick M. Remley, Jr. is chairman of the Video Tape Recording Committee, Society of Motion Picture and Television Engineers, and technical director of the University of Michigan's Broadcasting Service.

**RADIO-ELECTRONICS:** Gentlemen, would you tell us how the Oslo conference came about?

**DR. BROWN:** From time to time, the member countries of the United Nations wish to discuss matters in the areas of radio, television and communications. Routine specialized topics are rarely discussed in the General Assembly, but usually handled by the UN agency responsible for such affairs. The particular agency for radio, television and communications is known as the ITU—International Telecommunications Union.

**R-E:** Then the ITU sponsored the Oslo conference?

**MR. REMLEY:** Not directly. ITU is a large organization, involved in many fields of

\* "Color Television Throughout the World," January 1965; "The Case for NTSC in Europe," March 1965; "Color Television Systems: Which Way Will Europe Go?" July 1966.

international communications. One of ITU's divisions is known as the CCIR, from the French-language initials for International Radio Consultative Committee. The Oslo conference was the eleventh fully attended assembly of the CCIR. A previous meeting of a portion of CCIR at Vienna set part of the agenda for Oslo, and the discussion of a single worldwide color-television system was scheduled.

**R-E:** How many delegates to this color-television conference were there?

**DR. BROWN:** There were nearly 800 delegates to the conference, but color television was only one of the subjects discussed. You see, CCIR consists of 14 study groups, which are concerned with all forms of radio communications, their standards and definitions, and so on. Study Group XI is concerned with television, and color was formally discussed at the meetings of this group.

C. Hoyt Price, of the State Department, was head of the US delegation to the full CCIR conference. Arthur Hall, of Bell Laboratories was spokesman for the US in Study Group XI, to which I was a delegate representing industry. There were some 12 or 15 other delegates to SG XI from the US, by the way, including people from the FCC.

**MR. REMLEY:** I participated primarily in Study Group X, where we were concerned with things like television film standards, for example. However, I attended some meetings of Study Group XI, and my own group discussed color-television problems, but we took no official action.

**R-E:** How was the question of a universal color-television standard brought up?

**DR. BROWN:** First, let me say there's quite a difference between a *standard* and a *system*. A standard is a rule or definition, established by government or industry, which everyone uses. A good example is

the US standard of 525 horizontal lines in a complete television frame or picture. A system, on the other hand, is a method or means of accomplishing some goal. NTSC and SECAM are two different color-television systems; both can be used with 525-line standards, as well as with other standards.

At the beginning of the Oslo conference, Study Group XI Chairman Erik Esping, of Sweden, asked two questions of the delegates: "When do you expect to start color-television broadcasting in your country?" and "What system or systems do you prefer?" The chairman then asked for "expressions of opinions," not votes. These expressions showed that the various countries favored a total of 4 systems. [See Table I.—*Editor*] It was asked if there should be a single worldwide system, and if so, which one? Well, it was obvious that with such a large group—about half the 800 delegates to the entire conference—very little could be accomplished toward arriving at some sort of agreement. The group was just too large and unwieldy. The chairman recognized this, and adjourned the meeting for several days after suggesting discreetly that some "cloakroom bargaining" occur before another meeting.

**R-E:** Could you explain where the various systems were developed and what differences exist between them?

**MR. REMLEY:** SECAM III is a French development, like its earlier and now-obsolete predecessors SECAM I and II. SECAM III seems inherently inferior to the other systems. It uses an FM subcarrier which is always present and causes interference in some pictures, depending on scene composition. The overall picture quality is often relatively poor. The system requires a complicated receiver, which would probably be more expensive to manufacture than receivers for the other systems. SECAM III's advantages are that it can be recorded easily by ordinary monochrome video tape machines and can be transmitted by limited-performance cable and microwave systems.

SECAM IV is the French name for

## Definitions

<b>ART</b>	Additional Reference Transmission
<b>CCIR</b>	International Radio Consultative Committee (UN)
<b>NIR</b>	National Research Institute (USSR)
<b>NTSC</b>	National Television System Committee (US)
<b>OIRT</b>	International Radio and Television Organization (USSR and satellites)
<b>PAL</b>	Phase Alternation Line
<b>SECAM</b>	Sequential by Memory



Dr. George H. Brown of RCA (left), and Frederick M. Remley, Jr. of SMPTE (right).



**Table I—Color-system Preferences by Country**

System	Country	Start	
NTSC	Canada	Sept. 1966	
	China		
	(Nationalist)	1968	
	Ecuador	Undecided	
	Japan	Sept. 1966	
	United States	1953	
	Saudi Arabia	Undecided	
	PAL	Australia	Undecided
		Denmark	Undecided
		Finland	1970
Germany (West)		1967	
Iceland		Undecided	
Ireland		Undecided	
Lichtenstein		1970	
Netherlands		1967-70	
New Zealand		Undecided	
Norway		1970	
SECAM	South Africa	Undecided	
	Sweden	1968	
	Switzerland	1970	
	United Kingdom	1967	
	Algeria	1970	
	Bulgaria	1970-1973	
	Cameroon	1970	
	Central African Republic	1970	
	Cuba	1973	
	Greece	1975	
SECAM III	Rumania	1970	
	Yugoslavia	1969-1970	
	Colombia	1976	
	Congo		
	(Brazzaville)	Undecided	
	Czechoslovakia	1970	
	Dahomey	1970	
	France	1967	
	Gabon	1969	
	Hungary	1970	
SECAM IV	Ivory Coast	1969-1970	
	Lebanon	1967-1968	
	Malagasy	Undecided	
	Mali	1970	
	Monaco	1967	
	Mongolia	1969	
	Niger	Undecided	
	Poland	1967	
	Senegal	1970	
	Togolese Republic	1970	
SECAM IV	Upper Volta	1971-1972	
	USSR	1967	
	Mauritania	1969-1970	
	Portugal	Undecided	
	Tunisia	1969-1970	
	Miscellaneous answers		
	Abstained	Austria	
	Evasive answer	Belgium	
	No preference	Kuwait	
	Undecided	Brazil	
	Congo (Democratic Republic)		
	India		
	Iran		
	Israel		
	Italy		
	Jordan		
	Kenya		
	Luxembourg		
	Mexico		
	Peru		
	Spain		
	Turkey		

the same system the Russians call NIR. Both countries shared development of the system, and have agreed to share credit. SECAM IV has never been field-tested. It looks good on paper, and should be easily handled by video tape, cable and microwave. We don't know for certain what receiver requirements are. DR. BROWN: A great deal has been said of the ability of PAL and SECAM to overcome differential phase errors. It was fully proven in 1965 that SECAM worked a benefit in the presence of differential phase, and SECAM did not suffer too much from circuit noise. But, in the presence of both noise and differential phase, SECAM failed miserably. Furthermore, NTSC has been transmitted over a thousand miles on the Russian microwave system, from Moscow to many cities in Western Europe, and from Rome to London. The NTSC signal suffered very little degradation in these transmissions. The French attempted the same feat with SECAM and didn't make it.

PAL is a West German development, and at least it works, which is more than you can say for SECAM. Its primary advantage is its transmission quality, which is excellent. It can be handled well by limited-performance cable and microwave facilities, as well as video recorders.

The Germans want to use full PAL all the way from the camera to the receiver, which isn't necessary. Besides, using full PAL makes the receiver more costly than it needs to be, and is PAL's major defect. We estimate that a PAL receiver, produced in the US, would cost the consumer \$40 to \$50 more than an NTSC model.

The Germans claim that PAL alleviates ghosting and multipath distortion—which it does. But they make a big thing out of this feature, while we in the US know that, with few exceptions, a good antenna takes care of ghosting. PAL wasn't developed to avoid multipath—it was developed to overcome transmission problems.

R-E: What transmission problems?

MR. REMLEY: Most European cable and microwave transmission facilities have been built without enough phase and amplitude linearity to handle NTSC color. To use NTSC in Europe would mean either rebuilding many intercity transmission channels or not using networks. It's too bad this is so, for I think that unofficially many delegates felt NTSC was the best system, technically.

Unfortunately, although simple to manufacture, simple PAL receivers have at least one serious defect—line crawl. Full PAL avoids this defect. The latest version of full PAL, by the way, while supposedly good on video tape, raises new problems. PAL gates the fields 1-2-3-4, unlike NTSC, and keeping

track of the fields could be a problem, and might entail a more complicated tape machine.

R-E: Was ART proposed?

MR. REMLEY: ART, for Additional Reference Transmission, is really NTSC with additions. [ART may also be used with PAL.—*Editor*] Its development is still incomplete, as work was done and papers filed almost simultaneously by both British and West German researchers. While never considered formally at either Vienna or Oslo, it was unofficially proposed by some as a simpler, cheaper alternate to PAL.

R-E: Was NTSC proposed, and did it have any chance at Oslo?

DR. BROWN: Yes, the US position favored NTSC. We have used it here since 1953: Japan uses it, and Canada started using it last September. There are at least ten million NTSC receivers in use in the US alone, to say nothing of Japan and Canada. Compare this with possibly a few hundred experimental PAL and SECAM receivers. We've had time to work the bugs out of NTSC, and I don't think anyone contests the fact that it looks very good today.

American industry has spent a lot of money developing NTSC color, and the American people have a lot of money invested in it. It would be foolish to scrap all that—which is why the US won't change our system. The British agreed with us until we got to Oslo. No, I'm afraid NTSC didn't have much of a chance at Oslo.

R-E: Why not?

DR. BROWN: Well, at one point, the chairman of Study Group XI asked: "Are you in favor of a single system of color? If so, are you authorized by your government to change your vote?"

The Germans answered that they could change their vote, but only after returning to West Germany and consulting with 5 or 10 agencies and committees, which would take nearly a year. The British said substantially the same thing. The French said they had the freedom to vote for either SECAM III or SECAM IV. The Belgians were very confusing in their answer.

R-E: In other words, in spite of NTSC's obvious technical advantages, except for European cable and microwave problems, the delegates would not favor NTSC, nor any other single system. Why do you suppose this happened?

DR. BROWN: Each country's decision to favor a certain color system was political, not technical. For instance, PAL is supported by West Germany, Great Britain and several other European countries. It may become a European standard. But Russia will never adopt a German system, because of the deep anti-German feeling that still exists from World War II. Similarly, France refuses to consider PAL because of the pride



they feel in their SECAM.

R-E: Were engineering features of the various systems considered *at all*?

MR. REMLEY: Engineering features were the ostensible reasons for favoring one system over another. As mentioned earlier, European transmission circuits make NTSC transmission more difficult there at present. And PAL is touted as a great cure for ghosting. But underlying the technical reasons were political motives.

R-E: What about the possibility of a compromise?

DR. BROWN: The French made a suggestion to that effect, but it wasn't much of a compromise. They proposed that all member countries stop their present research on NTSC, PAL and any other systems, and pool their resources for one year to perfect SECAM IV. If at the end of one year, SECAM IV proved to be a good system, it would be adopted as the worldwide system. If SECAM IV didn't work out, we would then be forced, by the terms of the compromise, to adopt SECAM III as the system. France's proposal, I'm afraid, didn't get very far.

R-E: Was any position taken by Study

Group XI on a color system for the world, or for Europe?

DR. BROWN: No. The only result was that, after a couple of weeks of the delegates' doing nothing, Chairman Esping appointed a small group to write a report. This report outlined the engineering features of the systems that had been proposed. No single system was recommended or adopted by Study Group XI.

MR. REMLEY: It was unfortunate, I think, that there was no agreement. I believe the various nations of the world are playing ostrich; many have too little concern about seeing what's going on outside their own countries—and I include the US in this statement. Think of what a tremendous advantage a single worldwide system and standard of both monochrome and color television would be! With satellite relays and possibly direct satellite-to-home telecasting, a single system and standard would permit instant communication between all nations.

Such events as the Olympic Games, President Kennedy's or Winston Churchill's funeral, Queen Elizabeth's coronation, could be shown live to the entire

world. A single pooled camera crew could handle the origination. At the present time, such an event requires a completely separate camera crew, with tons of equipment, for each system in use. Of course, you can use film, which is playable equally well on all systems, but you lose immediacy.

DR. BROWN: It would be nice to have a single worldwide system, but I don't think it's possible—at least not through the UN. You've got to remember that most actions of the UN are basically unenforceable. Even if a decision is reached, it's subject to voluntary compliance by member nations. What do you do if several countries decide not to cooperate?

R-E: Several monochrome systems are presently in use in the world [see Table II—*Editor*]. The British have used 405 lines for some time, and the French, 819 lines. Most of the rest of Europe uses 625 lines. Recently both Great Britain and France started supplementary 625-line services, while maintaining their other facilities. Do you think this heralds a single European monochrome standard?

DR. BROWN: Well, there was general agreement of Study Group XI several years ago that when anyone went to color in Europe they'd do it with 625 lines. You must remember that 625 lines is the 50-field equivalent of the US 525 lines, which is of course on 60 fields. There are some differences between British, French and other European 625-line systems, but these could well be ironed out and we *might* see a single European standard.

MR. REMLEY: Speaking of 50-field standards, which are used in Europe because of 50-Hz power lines, the use of 50 fields and 25 frames causes noticeable flicker as compared with our system, which uses 60 fields and 30 frames.

R-E: At present, what facilities exist to allow, say, British audiences to view a live US telecast?

MR. REMLEY: *Standards converters* are used. The US networks have them—at least in New York City—and the BBC and others have them in Europe. They are complicated, expensive, and may reduce definition. There are two types—electronic and optical. When the frame rates of the two systems are identical, it's possible to use an electronic converter, which gives the better picture.

R-E: To summarize, then: The UN-sponsored Oslo CCIR conference did not result in a decision to adopt a single world system of color television. It did show, however, that the various countries grouped themselves around three systems—NTSC, PAL and SECAM. These groupings seem to be political, and the technical advantages and disadvantages of the three systems were not the main reasons for the groupings.

END

Table II—World Television Standards

System	British	US	French	CCIR	Irish	OIRT	French
No. of Horiz. Lines	405	525	625	625	625	625	819
Video bandwidth (MHz)	3.0	4.2	5.0	5.0	5.5	6.0	10.4
Channel Bandwidth (MHz)	5.0	6.0	7.0	7.0	8.0	8.0	14
Sound-to-picture spacing (MHz)	-3.5	+4.5	+5.5	+5.5	+6.0	+6.5	±11.15
Horiz. freq. (kHz)	10.125	15.75	15.625	15.625	15.625	15.625	20.475
Vert. freq. (Hz)	50	60	50	50	50	50	50
Picture modulation	+	-	+	-	-	-	+
Sound modulation	AM	FM	AM	FM	FM	FM	AM
Where in use	Hong Kong United Kingdom	Canada US and most of Western Hemisphere Cambodia China (Nationalist) Iran Japan Korea Phillippines Thailand	Belgium France	Most of Europe and Africa Argentina Australia India New Zealand Pakistan Syria Turkey United Kingdom Venezuela Yugoslavia	Ireland	Romania Bulgaria China (Red) Czechoslovakia Hungary Poland Rumania USSR	Algeria Belgium France Luxembourg Monaco Tunisia



# The Professional Touch for CB

By JACK DARR

IT MAY NEVER HAVE OCCURRED TO YOU but the Citizens' band is truly the domain of the "amateur." Not the licensed ham, but the honest-to-John amateur in the dictionary sense of the word—a person unfamiliar with two-way radio theory and practice. Since many CB units are installed by these enthusiastic but inept amateurs, the professional touch is usually lacking. Overall performance often can be improved significantly with established techniques.

Disappointing useful range is the most frequent complaint from CBers. With only 5 watts output, CB sets suffer severely from mistuning, poorly located or inefficient antennas or mismatched transmission lines. Many sets enter the shop suffering primarily from "screwdriveritis" in one or another of its several forms. There seems to be an unexplained madness, not entirely limited to CB enthusiasts, that forces an otherwise logical man to shove a screwdriver blade into the slot of any adjustment screw and give it a couple of turns. As a result, a careful tuneup often will increase the talk-in range considerably.

Make sure the antenna-base flange is well grounded (I've found them floating). The rf output impedance of most CB rigs is 50 ohms, but for reasons of economy a 75-ohm transmission line occasionally is used. This won't have much effect in a mobile installation, but where the cable run is lengthy, as at the base station, the loss will be significant. For base-station transmission lines, low-loss coax like RG-8/U also will give a measurable improvement in output—about 3 dB per 100 ft.

Check the length of the output coax on mobile rigs. Many antennas are designed to accept a half-wavelength cable—about 11 feet 9 inches, or a multiple of that length. The half-wave cable is usually long enough to reach from a dash-mounted set to a rear-mounted antenna. The direct route is best—under the floor mat, alongside the driveshaft tunnel, then into the trunk.

The most useful accessory for antenna tuning is a field-strength meter. You can make a simple yet effective one from a diode, a pickup rod and a milliammeter (Fig. 1). A tuning device of this type reads only radiated rf power. A peak on the meter means the antenna is tuned for maximum output, and that's what you're after.

To use the meter, set the field-strength detector near the antenna and place the meter where you can see it. Peak the antenna-tuning adjustments for maximum deflection.

Some CB transceivers include a tuning meter on the panel as an aid to

tuning the antenna. A typical circuit is shown in Fig. 2. These devices are useful for preliminary adjustments, but for maximum output use the reading obtained from the field-strength meter, which indicates actual radiated rf energy. Panel meters are usually diode-coupled to the rf output stage, and a lot of things can happen between there and the antenna. If the panel and field-strength meters peak at different tuning-adjustment settings, make a careful investigation, because something's wrong. Check grounding, antenna length, lead-in length, etc.

A TVI trap is usually provided in the output stage to attenuate the second-harmonic radiation which falls nicely into channel 2 on 54 MHz. A portable TV set is a very good indicator for use in adjusting the trap to eliminate any interference.

Left alone, most receiver i.f. sections are very stable and trouble-free, but screwdriver mechanics find the slotted adjustment screws impossible to resist. If receiver sensitivity seems low, a quick check of i.f. alignment using a signal generator often will produce a big improvement. A fairly reliable indication of "screwdriveritis" can be obtained by checking the i.f. cans. Shaved metal at the tuning-adjustment openings suggests the use of a carpenter's screwdriver and no professional ability.

In all mobile units, the antenna stage of both receiver and transmitter

must be peaked after installation to compensate for changes in antenna effects, stray capacitance, etc. You can peak the receiver using a signal radiated from the signal generator.

It's often a good idea to sweep-align the i.f.'s to attain maximum selectivity. Some technicians have signal generators with AM sweep capabilities—the Hickok 188, for example. Others find their TV sweep generator can be tuned to provide a usable signal—at the 27-MHz carrier if not at the 455-kHz i.f. frequency. A sweep curve can be obtained by feeding the signal in at the antenna, if necessary. Sweep width should be cut down to about 1.0 MHz or less, but you can "read the curve" by increasing the horizontal sweep of the scope and spreading the trace enough to give a usable display.

Sweep alignment often reveals the presence of incipient oscillation or regeneration in rf or i.f. stages. A good response curve will be symmetrical, rising smoothly to a slightly rounded top, then falling off without notches or too wide a skirt. If feedback occurs in the circuit, you'll see a characteristic triangular-shaped trace with a pronounced sharp peak and a ragged-looking overall appearance. While a signal will pass through the i.f.'s, the audio will be harsh and screechy. It's also characteristic of feedback that, while you're tuning the i.f. strip, the curve will peak normally to a certain point, then suddenly break up as the stage goes into oscillation.

In mild cases, the malady can be cured by overall correct alignment. In severe cases, however, a filter capacitor probably will have to be replaced somewhere. The commonest cause of unwanted oscillations is insufficient capacitance to prevent feedback through the power supply.

You also can use the scope to obtain an indication of overall transmitter performance. Set a vertical-channel probe near the antenna, key the transmitter, and pick up the "bar" pattern of the rf carrier. Modulate the transmitter with a tone generator or by whistling into the mike. Look for the increase in pattern height that indicates upward modulation. Full modulation should increase the output by 22.5%. If the pattern shrinks or remains the same, there's trouble in the modulator section or in the final output stage.

Even though CB transceivers generate low-power signals, they should be fed into a dummy antenna during bench checks. A suitable load can be made from a pair of No. 47 pilot lamps in parallel, connected to a suitable plug and cable.

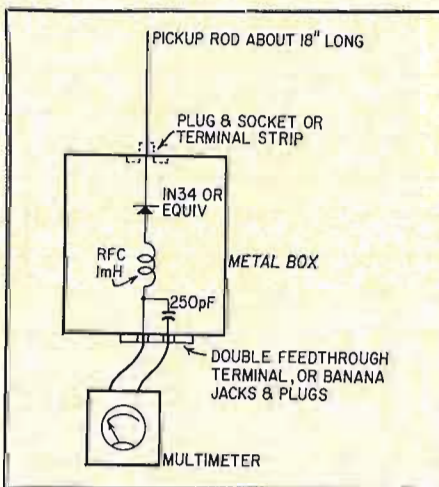

Fig. 1—Simple field-strength meter for CB.

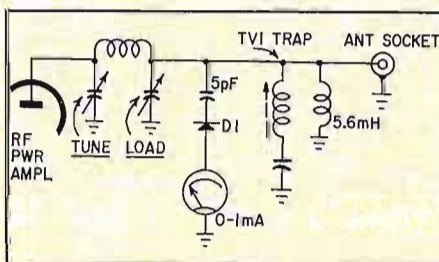
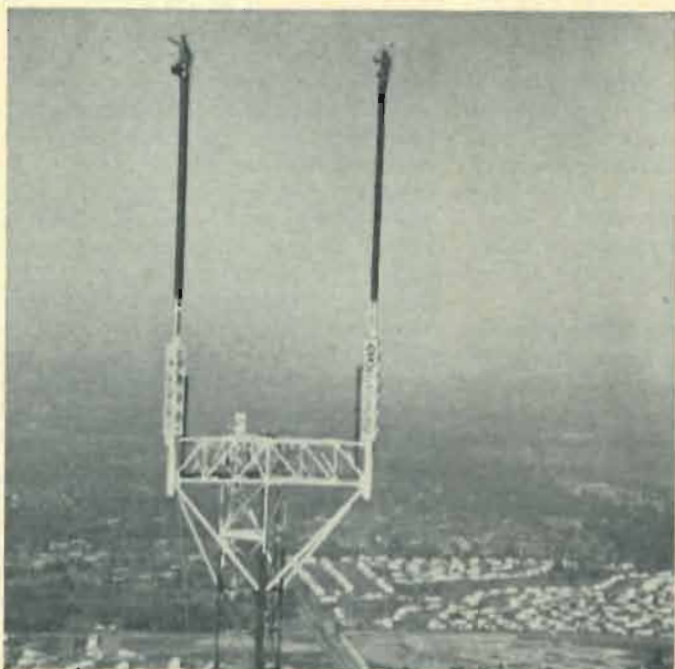

Fig. 2—Transmitter output-tuning meter.



# WHAT'S NEW



**WORLD'S FIRST MULTIAN TENNA TOWER** for uhf broadcasting stands 1,050 feet above Detroit area, where it's used by WKBD-TV and WTVS. WJMY-TV will add third antenna later.



**NO-TALK TELEPHONE MADE BY WESTERN ELECTRIC** speeds filing of quality-control information. The instrument has new-style pushbuttons, but no handset. As worker tests an assembled product for quality, she "dials" data-storage department and "punches" her inspection results into a computer bank.

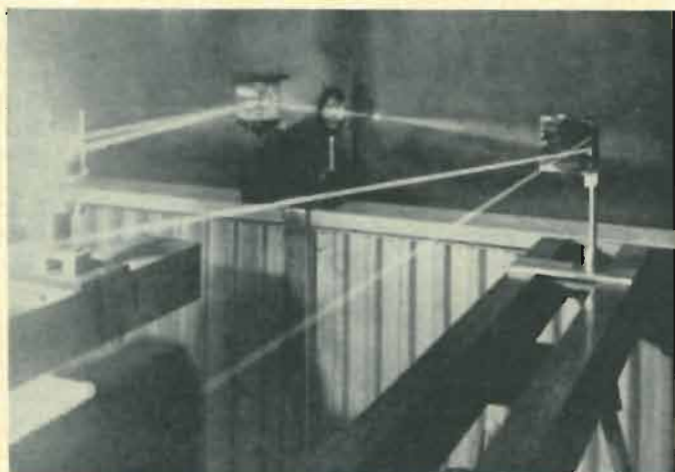

**INFRARED LASER BEAM CONVERTED TO GREEN** at several hundred megawatts of power. Accomplished by Compagnie Générale d'Electricité in France, green coherent light will bring greater accuracy in laser telemetry for determining satellite orbits. Technique may also be used for lunar mapping.

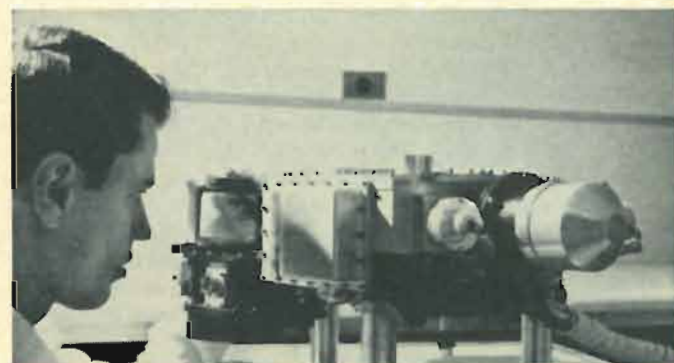

**NEW CAMERA USES DIELECTRIC PLASTIC TAPE**, records image electrostatically. It's designed for space-vehicle use by NASA in weather study and planet mapping. Single-unit camera and recorder is nearly immune to radiation, uses 100 feet of tape.



**SAMPLE PICTURE TAKEN BY RCA-BUILT DIELECTRIC CAMERA** illustrates good definition. Tape may be replayed or erased and reused indefinitely. Base of tape is coated with a gold-copper conductor, an arsenic selenide photoconducting material and a layer of insulating material. Optical image is "written" into insulator and stored until read out or erased. **END**



# DIRECT-VIEW 3-D IMAGES!

A startling new scientific technique can create images so real you almost think you can touch them

By ALLEN B. SMITH

THREE-DIMENSIONAL IMAGES, WHICH could be viewed without glasses, goggles or filters, have long been dreamed of. Most of us are so accustomed to viewing photographs—which are really abstract representations of real objects—that we find it difficult to imagine solid-appearing images. Such images are no longer dreams. They are being created right now.

During a recent trade-show demonstration of a new optical technique for creating images of remarkable reality, a respected physicist viewed an image intently, then reached out his hand. Encountering nothing but air, he shook his head slowly. "I've been reading about this for months," he said. "But I honestly didn't expect to see such a perfect image. It's really a little spooky!"

Known variously as laser photography, lasography, lensless photography and wavefront-reconstruction photography, *laser holography* resembles photography in only one respect—each records a pattern of light waves on a light-sensitive plate or film.

Human vision depends on the fact that white light falling on an object is reflected in several ways, each of which carries some specific information about the object. Three types of information are particularly significant: intensity (amplitude), direction (phase) and color (frequency). If it were possible to record all these elements, the object could then be reconstructed in image form. The recreated image would be identical to the original object; it would, in fact, be impossible to distinguish the two except by touch.

The problem is complex, however, because white light contains all wavelengths of visible light, from 3,800 Ang-

stroms (violet) to 7,500 (deep red). Since each microscopic point on the surface of any object reflects the amplitude and phase, as well as the color, of each discrete wavelength, white light reflected from even the simplest object contains a staggering amount of information. No means has yet been discovered to record it all.

A logical approach to the problem would be to develop some means of recording the amplitude and phase information using spectrally pure light—that is, light of a single wavelength. Early attempts by Gabor to use filters and minute point-source apertures to obtain useful narrow bands of monochromatic light were handicapped. Such techniques produced illumination levels too low to be useful. Gabor did, however, develop a technique for recording amplitude and phase information on what he called *holograms*. These holograms (from the Greek *holos*, meaning whole) were light-wave records, captured as patterns on photographic plates, which contained phase and amplitude information from reflected light waves. Image quality of early holograms was very poor, however, as a result of the impure light used to form them.

Nearly 15 years elapsed between Gabor's early experiments and the development of a light source having the unique properties necessary for making high-resolution holographic images. With the development of the laser, experimenters in several laboratories—particularly at the University of Michigan—began using the laser beam for making holograms. Made to order for this kind of optical recording, the laser emits light of a specific frequency from an extremely small point source.

These qualities of temporal (frequency) and spatial (from a single source) purity are known as *coherency*, the unique quality of laser light.

The processes of recording reflected light waves (making a hologram) and reconstructing the recorded waves (making a visual image) depend on two basic optical phenomena. The first is known as *interferometry*, an optical method for converting phase relationships into equivalent visual amplitude variations that can be recorded as a photographic pattern. The second, *wavefront reconstruction*, is a technique for transforming the pattern of recorded light waves on the hologram into an equivalent visible light beam. This light beam exhibits precisely the same characteristics of amplitude and phase as the light used in making the hologram. In other words, the reconstructed image looks exactly like the original object.

If coherent light from a laser is beamed onto a single reflective point, the reflected wave will radiate from the point in a series of ever-expanding, concentric, hemispherical energy pulses called wavefronts (Fig. 1-a). These wavefronts travel outward from the point until absorbed or diffused. Suppose that, instead of a single point, the laser beam illuminated an object consisting of a large number of reflecting points. (Any two- or three-dimensional object contains such points.) In this case, the result is a complex wave pattern made up of all wavefronts reflected from and concentric to each separate point. This badly scrambled wave (Fig. 1-b) contains all the data required to form an image of the object.

Since the complex wave cannot be recorded directly without destroying certain essential information, it must be modified by using interferometric tech-

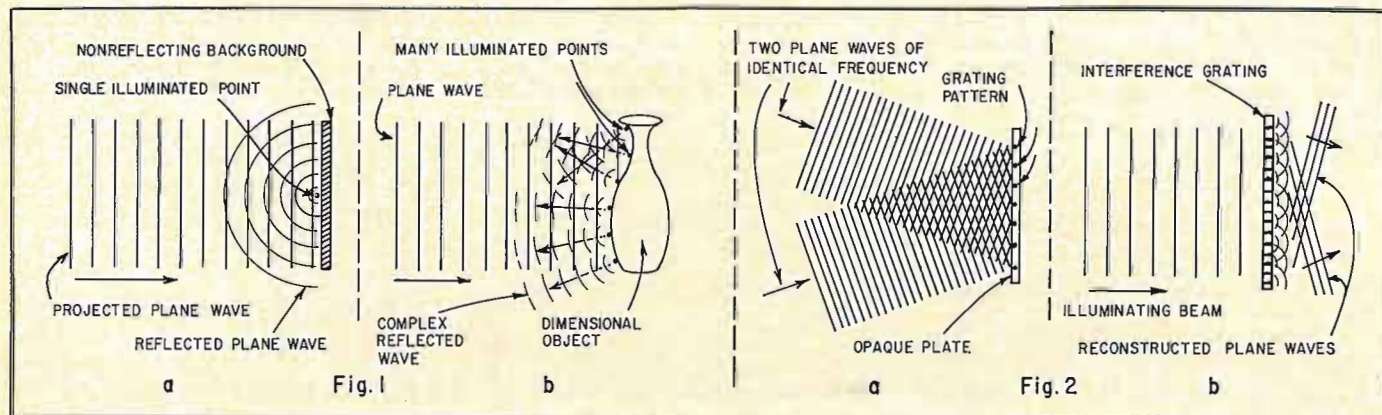
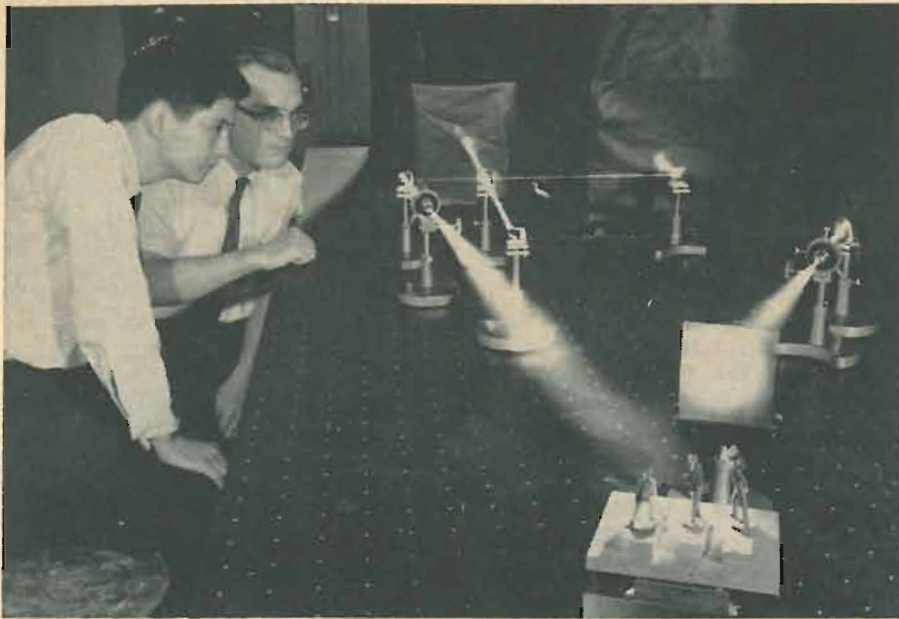

Fig. 1—Coherent light reflected (a) from a single point and (b) from many points. Note circular reflected wave patterns.

Fig. 2—Two laser beams interact (a) on plate, form grating. Illuminating beam (b) recreates original waves from grating.





Bell Labs scientists examine mixed-beam holographic apparatus making color recording.



Hologram grating pattern and whorls.

niques. The phase variations are thereby converted into amplitude equivalents. When this is accomplished, a photosensitive plate can be used to form a permanent record of the complex wave.

Fig. 2-a illustrates a simple case of light-wave interference in which two identical plane waves (wavefronts of coherent light perpendicular to the direction of the beam) fall on an opaque surface from different angles. These waves form a series of parallel interference fringe patterns on the opaque surface. The distance between the fringes depends solely on the angle formed by the two waves.

The fringes appear because at some points on the surface the two plane waves arrive in phase, their amplitudes adding and producing areas of increased illumination. At other points, the waves arrive out of phase so their amplitudes cancel, producing areas of reduced illumination. Intermediate points have values somewhere between light and dark. A chemically processed photographic recording of the pattern contains a series of parallel lines called a *grating*. When this grating is illuminated by a beam of coherent light as shown in Fig. 2-b, interaction between the light beam and the grating creates a procession of plane waves identical to those which formed the grating. The original waves are thus reconstructed.

In making an interference pattern, when one of the coherent waves is a plane wave and the other a complex wave reflected from a three-dimensional object, an interesting situation develops. Instead of being regular, the grating exhibits an irregularity which matches precisely the amplitude variations formed as the complex reflected wave strikes the plate. Where the am-

plitude elements of the complex wave are greatest, the fringes have highest contrast; where the wave amplitude is least, the fringe pattern is lowest in contrast. *Amplitude* variations in the complex wave, then, control *contrast* variations of the fringe pattern.

Since fringe spacing depends on the angle formed between the two light beams, the fringe pattern is relatively fine where the complex wave makes a large angle with the plane wave. Similarly, the pattern is coarse where the angle is small. *Phase* variations in the complex wave, then, alter the *spacing* of the fringe pattern.

Two of the foremost experimenters in the field of laser holography—Emmett Leith and Juris Upatnieks of the University of Michigan at Ann Arbor—have described the formation of holograms, using the reference-beam method outlined above, in terms of communications theory. In their useful analogy, the plane wave or reference beam is likened to a local oscillator and the complex wave to a modulated signal. The photographic plate, therefore, acts as a mixer stage for the two signals. Leith and Upatnieks, in fact, illustrate mathematically that fundamental, sum and difference light-wave frequencies are recorded on the plate and later recovered during wave reconstruction.

This analogy provides a good basis for describing what happens when the beam of coherent light from a laser is directed onto the completed hologram. The process of reconstruction is basically the reverse of the process which produced the hologram. The coherent light beam, when projected on the grating, interacts with the recorded fringe pattern. The effect is to impress the amplitude and phase information contained in the

hologram onto the light beam.

When the light beam meets the hologram at the same angle as did the reference beam during the recording process, the light emerging from the hologram consists of two useful signals. The first consists of the difference frequencies, which are identical to the original complex wave used in constructing the hologram. This reconstructed wave generates a virtual image which seems (to an observer) to lie on the light-source side of the hologram. This image is an exact replica of the object from which the original complex wave was reflected. It resembles a solid object.

The second signal consists of the sum frequencies, and these form a second image that seems to hang in mid-air between the viewer and the hologram. This combined image has a "pseudoscopic" appearance; some of its elements are reversed, making it look unnatural. Further processing of this second image (as discussed by Rotz and Friesem) produces an image of uncanny reality.

Using the two principles described, it's possible to record the complex light waves reflected from any three-dimensional object and then to "play back" that recording and reconstruct the complex wave. Since the reconstructed wave is identical to the original in all important aspects, the image formed by it is identical to that formed by the original object. Simply stated, the hologram captures the light waves reflected from an object, stores them and later releases them on command—a very satisfactory "light recorder."

The hardware required to make a holographic recording is quite simple, with the obvious exception of the all-important laser-beam generator, and is arranged as in Fig. 3. Since the illuminat-



ing and reference beams must be of exactly the same wavelength, a beam-splitter-and-mirror setup is used. This produces two coherent beams having the same wavelength. Diverging lenses A and B are microscope elements used to spread the sharply focused laser beams enough to light the entire object and cover mirror B.

Both mirrors are front-surface types used to avoid specular breakup and distortions of the beam due to double imaging. The photographic plate is a type used primarily in astronomical photography. It has extremely high resolution. (Eastman Kodak makes one type, the 649-F, in various sizes.) The object can be any three-dimensional form, the size of which does not exceed the incident-beam coverage area.

When developed (by ordinary chemical means) the photographic plate becomes the completed hologram. In appearance, the hologram resembles a granular photographic negative of a concrete slab, sometimes showing concentric *whorls* which look like fingerprints (see photo). (These whorls serve no useful purpose; they are simply noise elements caused by dust particles on the mirrors, beam splitters, lenses and photographic plate.) When examined under a microscope, the hologram reveals only an apparently random arrangement of exposed silver granules.

Holograms constructed as described here have a curious property. Each segment of the hologram contains all information necessary to reconstruct the original complex wave. This is true because each spherical wave advancing on the plate passes across the entire plate, exposing the complete surface of the emulsion. Because of this characteristic, two holograms can be made from one simply by breaking it into two segments. Increasingly smaller pieces, how-

ever, produce images of decreasing fidelity and resolution.

Because of the long exposure times and the very short wavelength of the light beamed from the laser, absolute rigidity of all hardware elements is required. Movement as slight as three or four millionths of an inch can inhibit formation of the pattern necessary for reconstruction. For this reason, most setups are made on massive steel plates with finely machined surfaces.

Wavefront reconstructions from the hologram are made using the arrangement of Fig. 4. The laser source is generally the same one used in constructing the hologram, and the diverging lens is similar to that previously used. As described earlier, the laser beam striking the hologram interferes with the recorded grating and generates the sum and difference signals indicated in the diagram. The unique optical characteristics of the two images have been covered earlier.

The laser beam used in reconstructing the image must strike the hologram at the same angle used during the recording process. This means the hologram can hold more than one set of information. Several entirely separate images may be recorded on a single photographic plate, using different reference-beam angles for each record. A succession of reconstructed images can therefore be produced simply by altering the angle at which the illuminating beam strikes the hologram. Using this property of discrimination, several experimenters have constructed images that appear animated.

The most recent development in the field was achieved last summer by Dr. George W. Stroke. He used a focused-image technique to obtain a three-dimensional laser-holographic image on an otherwise conventionally focused photo-

graphic plate. The hologram, observable in white light, has all the characteristics of holographic reconstruction described earlier. The importance of this new technique becomes clear when one realizes that the image is obtained using normal photographic procedures and equipment—lens, camera (though unconventional) and film—plus, of course, laser illumination and a reference beam. The reference beam, however, is introduced "in line" with the optical axis of the lens and reflected beam, not at an angle.

Several difficulties are found in conventional holographic techniques—"ghost images" and the spectral dispersion suffered in usual white-light reconstructions, for example. These are absent in the focused-image recording technique and in its white-light reconstruction. Sharpness and brightness levels of the images also surpass those previously attained by other methods.

Fig. 5 shows the basic setup for Dr. Stroke's technique. The focusing lens forms a conventional real image on the surface of the photographic plate, and the coherent reference beam is injected into the optical axis of the lens by the beam splitter. Two mirrors, along with the beam splitter, extend the path length of the reference beam so that it corresponds to that of the reflected beam. Interaction between the real image (formed by the reflected beam) and the reference beam provides the three-dimensional information in a manner similar to that used to record a conventional hologram. However, the familiar interferometric diffraction grating is not present. The image formed still is the result of an interference pattern, but one of a different class than that which forms a grating.

The focused-image hologram records only a small fraction of the information contained in a conventional hol-

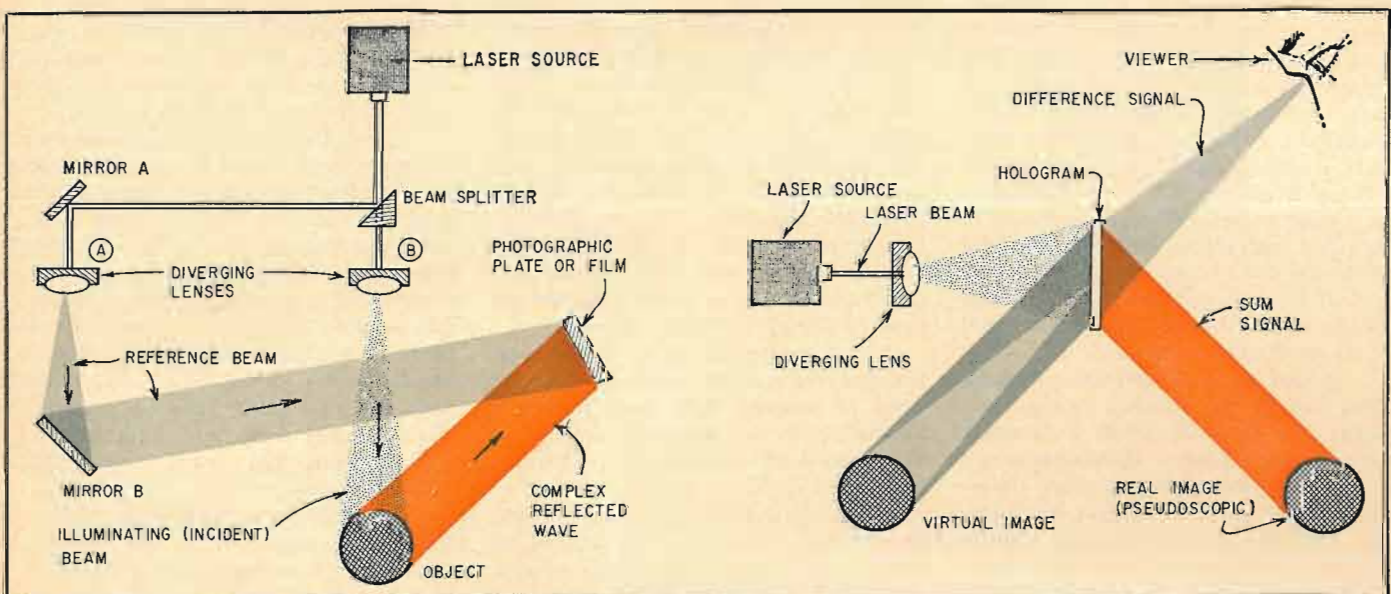

Fig. 3—The holographic arrangement for recording images.

Fig. 4—To view recorded holograms, this setup is used.



ogram and still allows reconstruction of a three-dimensional image of high quality. (With the lens-formed image, there is a 1-to-1 correspondence between each point on the object and every point on the plate.) In a conventional scattered-beam hologram, each point on the object is recorded at all points on the plate.) Focused-image holography, therefore, may solve the wide-bandwidth problem now associated with 3-D hologram transmission.

Most observers at holographic demonstrations ask how this new technique may be applied to everyday uses. There are many possibilities—three-dimensional motion pictures and television are two often discussed. There isn't space here for a complete summary of experimental work, but a few significant advances must be mentioned.

Most active research programs are seeking to overcome several factors which now restrict holographic techniques almost exclusively to the laboratory. There are several basic restrictions: exposure times are long; reconstructed images assume the color of the coherent light used; it's difficult to impart motion to the reconstructions, and there are extreme bandwidth requirements for image transmission. In all these areas, progress is being made.

Dr. Jerald Parker, a physicist for Electro-Optical Systems, Inc., has reported construction of an ionized-argon gas laser emitting light in the range of 5,145 to 4,545 Angstroms with a power of 1 watt. Because the light from this device lies in the most sensitive portion of photographic emulsions, required exposure times are reduced to about 10 seconds. Further promise comes from a technique (described by Jacobson and McClung) in which a mode-controlled pulsed laser has been used to produce high-resolution, two-beam holograms with exposure times of only 30 nsec.

One company, Technical Operations, Inc., is actually marketing a device called a Laser Fog Disdrometer which uses laser-holographic techniques to record all particles of fog, mist or other aerosols within a given three-dimensional space. Using a pulsed laser and exposure times of approximately 30 nsec, the device produces holograms that form images of the particles. The images can then be studied with all the advantages of parallax and dimensionality.

Other experimenters, notably Lawrence H. Lin and Keith S. Pennington of Bell Telephone Labs, and Dr. George W. Stroke and Antoine Labeyrie of the University of Michigan, have developed a method for making holograms that can be viewed using sunlight (or any other noncoherent white light). The holograms still must be constructed initially using laser illumination, however.

Lin and Pennington of Bell Tele-

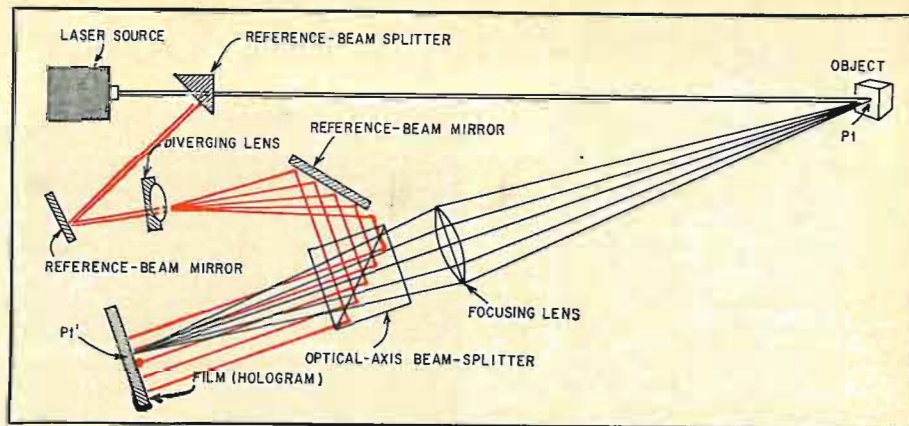

Fig. 5—This setup is used to produce a hologram on film which can be viewed directly.

phone Labs were among the first to create multicolor holograms using two laser sources emitting coherent light at different wavelengths. Employing a helium-neon device with an output at 6,328 Angstroms (red) and an argon-ion device at 4,880 Angstroms (blue), these scientists have developed a mixed-beam holographic technique capable of producing two-color reconstructions. Using the same basic concept, it should be possible to create full-color holograms and reconstructions as soon as laser devices having the required spectral colors are produced. Obviously, there are many potential applications.

In September 1965, engineers at Stanford University's Systems Technique Labs demonstrated the first holographic movies. Although very simple movements were recorded—steel balls rolling on a table and the hands of a wristwatch in motion—the technique laid the groundwork for further efforts to generate moving holographic images and present them for viewing by a large audience. The problems still are immense, but most serious experimenters are confident that dimensional motion pictures will be developed using holographic techniques.

Although wide-screen three-dimensional television in the home undoubtedly is years from actuality, Leigh and Upatnieks have fully described a television system employing wavefront-reconstruction techniques. As they describe the system, high-power pulsed-laser light sources—all locked in frequency to satisfy the coherency requirement—illuminate the scene to be televised. Using 10-nsec pulses, normal motion of the actors can be permitted without exceeding the wavelength of visible light. A continuous-wave laser of low illumination intensity, also synchronized with the pulsed lasers, is directed to a photosensitive grid in the camera system. This grid is similar to that of a standard image-orthicon tube. The coherent light reflected as a complex wave from the scene being televised falls on the detec-

tor grid and interacts with the CW-laser reference beam, forming the photoelectric equivalent of a standard hologram. The video signal resulting from scanning the fringe pattern can then be transmitted to the receiver.

The receiver most likely would consist of a screen of photochromic glass, a material which has extremely fine resolution. A laser beam, modulated by the transmitted video signal, would form a raster on the screen. Thus a hologram would appear on the screen for each field. A second laser, synchronized to the frequency of the studio-camera reference beam, would then illuminate the hologram creating the by-now-familiar virtual and pseudoscopic real images.

The fundamental difficulty in constructing a practical 3-D television system lies in the severe bandwidth requirements necessary to transmit dimensional video. The process which forms the interferometric fringe pattern generates frequencies extending beyond the present US bandwidth standard of 4.2 MHz. Because there is redundant information in a hologram, Stroke's focused-image technique described earlier seems the most likely solution to the bandwidth problem. Another possibility is the use of present light-wave-transmission techniques instead of rf-transmission methods. Another solution has been proposed by Winston E. Kock—the use of microwave, rather than laser, illumination. This method's feasibility has already been proved by R. P. Dooley and D. Duffy of General Electric. This light-source substitution would reduce the bandwidth requirement of the holographic video to the current US standard. It remains to be proved, however, whether adequate fidelity can be attained by this method.

Whatever benefit derives from these experimental efforts, the best is undoubtedly yet to come. So, make room in your life for a new basic technological tool that promises a broad range of communication, entertainment, research and analytical possibilities. END



# Triggered Scope for Color

By LARRY ALLEN

THE BARBER POLE WAS TURNING VIGOROUSLY. But not outside the barber shop—it was inside. And the pole was not motor-driven; it was electronic.

A few days before, Rocky had bought a brand-new 19-inch color set to entertain his customers while they waited for haircuts and shaves. It made a hit, too. That is, it did until Friday morning. Rocky had no idea there was trouble. The first three shows were black-and-white, and they looked fine. The first color show was another matter. Venetian blinds of color seemed to move around all over the screen.

By noontime Friday, there I sat, watching nine twisty barber poles wind their way up and down the face of that little 19-inch receiver. I had hooked up my color-bar generator, but couldn't get the colors to sync.

A bad tube, I thought, flipping open my tube caddy. A few minutes and I'd have the set (and Rocky) all settled down. Hah! Little did I know.

Tubes didn't do it. Neither did some hopeful twisting of controls, nor even one desperate, careful twiddle of the phase-detector transformer. Reluctantly, and with Rocky's pointed protests ringing in my memory, I hauled the set off to the shop. Rocky's parting reminder was a word picture of his Saturday customers sitting around with nothing to do but gossip and read papers and magazines. And something about not paying for a set that wouldn't work . . . I sort of tuned out that part.

I decided I'd try to get the little 19-incher going again before I finished my other calls. What helped me decide, a little bit, was a new triggered scope shining on its rollabout beside my bench—just waiting for me to try it out on a TV set. I had just got it all set up but hadn't had a chance to see if it was better than my regular scope.

Well, let me tell you—it was! I can't remember when I've gotten so enthusiastic about something. For the first

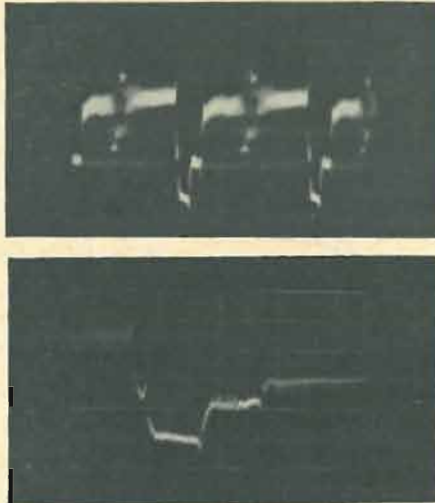

Fig. 1—Video waveform at top is expanded below with scope magnifier, showing burst.

time since I started servicing TV, I had the feeling I was really seeing what goes on inside a color set.

Anyway, I put this little color set on the bench and began scope tracing. There was a color show on channel 5, so I tuned it in. Take a look at the waveform I picked up at the video detector (Fig. 1-a). Did you ever see one that clear on a service scope? I never did. This was one line of color video signal. With the X5 expander on the triggered scope, I spread that waveform out like Fig. 1-b. Note how well you can see those burst cycles. What detail! It looked so good I wanted to play with the scope.

The thought of Rocky's parting words nudged me back to business. The coupling capacitor from the video detector to the first color amplifier (Fig. 2) is pretty small, so I didn't expect to get enough waveform at the color-amp grid to trigger the scope. But at the plate I found the waveform you see in Fig. 3-a; burst there was fine. (For your reference, Fig. 3-b shows the same waveform, but with no burst coming from the video detector.)

Again because of a small-value

coupling capacitor, the waveform (Fig. 3-c) at the grid of the burst amp doesn't tell much. Any burst information there is overcome by the flyback pulse that keys the tube on during burst period, to eliminate whatever video might remain in the waveform. Therefore, you can't tell if the burst is present. For that, go to the plate. What I found there (Fig. 3-d) showed that the burst was okay that far. Fig. 3-e shows how it would look without burst; keying action causes the horizontal-rate blip, contaminated with slight video.

But the scope showed nothing at one pin of the phase-detector diode. Working backward slightly, I touched the scope probe to first one end and then the other of the phase-detector transformer secondary. At both points I got the fine waveform shown in Fig. 3-f. The answer was easy: either the 330-pF capacitor was open or the board had a bad solder joint. Running a hot solder-gun tip over the connections cleared up the trouble.

Done. Tracked down in minutes by a triggered scope. Rocky had his set back for the Saturday games and it's been working fine ever since.

Yes, I could have found the trouble with any wideband scope, or even by enough testing with a vtvm. But I liked the waveforms I saw on the triggered scope—the feel of solid sync and the accuracy of the traces. There was no doubt of what I was seeing. Believe me, that makes waveform analysis twice as easy as it ever was before.

## Triggered vs recurrent sweep

How can a triggered scope show a waveform so much cleaner and more stable than a recurrent-sweep scope can? Partly because good bandwidth is usually built in, but even more because of how the trace is synchronized in a triggered-sweep scope.

Fig. 4 may help you understand synchronization in a recurrent-sweep scope. The sawtooth sweep oscillator runs all the time. A part of the vertical input waveform is fed (usually after it has been run through some of or all the vertical amplifier stages) down to a sync section. There it locks the sweep oscillator to the exact frequency of the input waveform. A switch usually allows you to sync on either the positive-going (Fig. 4-a) or the negative-going cycle (Fig. 4-b). With an asymmetrical wave, you generally choose the polarity of the most dominant leading edge. If the input waveform contains more than one frequency, as many complex waveforms do, the poor sweep oscillator has a tough time picking out a dominant frequency to synchronize on.

The sweep oscillator in a triggered scope is one-shot. It sweeps only once each time it is activated and then waits

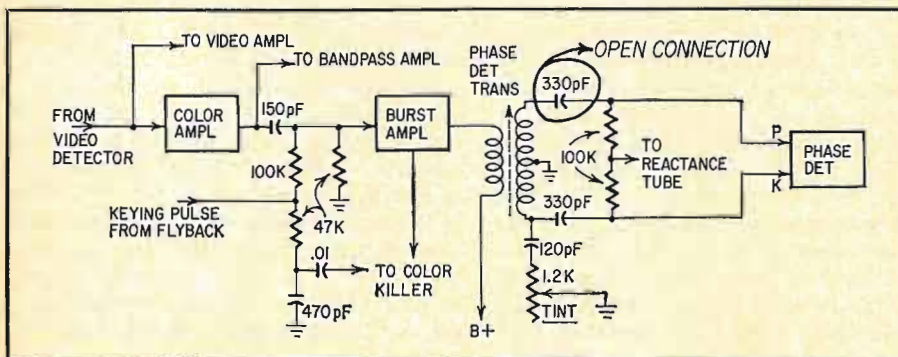

Fig. 2—Chroma circuit contained shifting-color fault, which was found with scope.



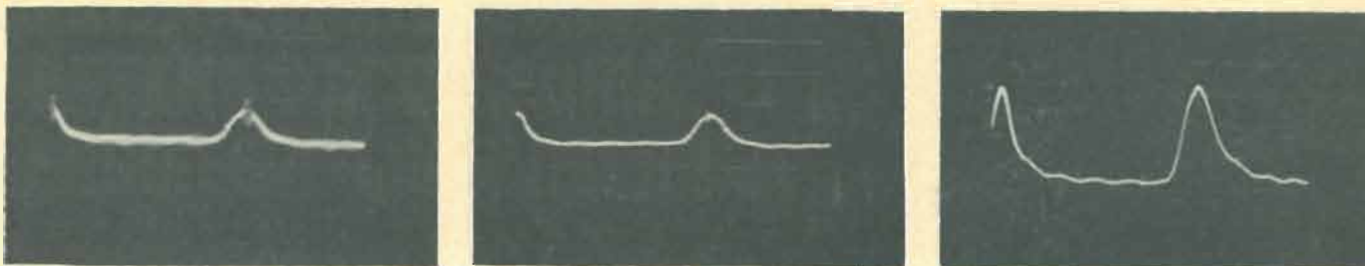
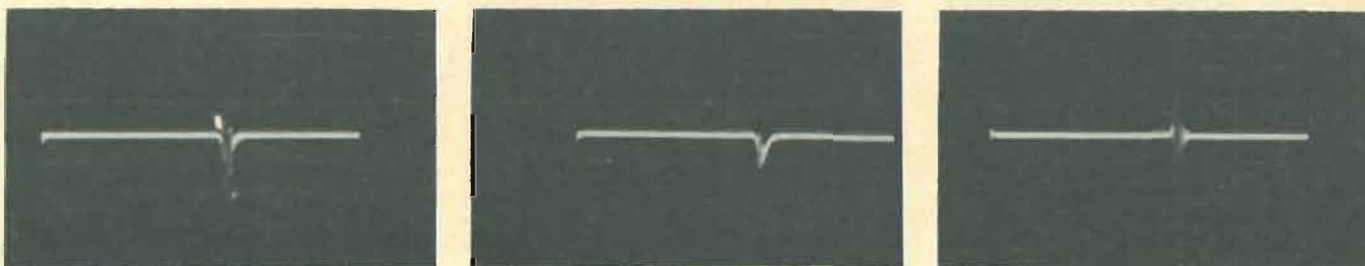

Fig. 3—Waveforms found at (a) color-amplifier plate, with burst; (b) color-amplifier plate, no burst; (c) grid of burst amplifier;



(d) plate of burst amplifier, with burst; (e) plate of burst amplifier, without burst; (f) phase-detector transformer secondary.

for another pulse of the chosen amplitude to trigger it again. On my triggered scope, the TRIGGER LEVEL control moves in either direction from zero-amplitude, so you can choose positive- (Fig. 5-a) or negative-cycle (Fig. 5-b) triggering. How far you turn the control from zero-center sets the level of input waveform that will fire the oscillator (Figs. 5-c and 5-d).

Once the triggering level is chosen, the sweep oscillator fires on the first excursion of the input waveform that reaches that level. The sweep moves the CRT beam across the scope screen at a speed that is chosen by the TIME/CM switch: the beam sweeps just fast enough to cross 1 cm of the scope graticule in the time chosen by the switch. Then the beam stops, snaps back to the left side of the scope face, and sits there waiting till some point of the input signal next reaches that triggering amplitude again. While the beam is sweeping the full screen width, the oscillator won't fire again, because the time constant chosen by the TIME/CM switch keeps the sweep going till it is all the way across the scope. Thus the TIME/CM switch can be set to show as many cycles as you wish of any particular waveform, no matter what triggering point (level) you choose with the TRIGGER LEVEL control.

So, you see, with this form of sync, you just set the TIME/CM switch to show the number of cycles you want to display (depending on the main frequency of the waveform), set the triggering with the TRIGGER LEVEL control, and the triggered sweep displays the trace you want, steadily and solidly.

Makes you wonder why everyone doesn't use a triggered scope, doesn't it? Cost has been a factor, but my scope is a kit type (a Heathkit Model IO-14) that didn't cost much more than a top-priced

service unit. Another factor is lack of familiarity; a lot of technicians just don't know how to use a scope with triggered sweep. The instruction booklet that came with mine shows in considerable detail how to put a triggered scope to work. Also, there are other books available that explain how triggered scopes work. Few mention, however, the steps to take to use a triggered scope specifically for troubleshooting color TV. Here are a few hints.

#### Setting up the scope

Follow the instructions that come with the scope for turning it on, adjusting intensity, focus, positioning of beam, etc. Turn up the graticule light, as the centimeter marks are a useful guide when analyzing waveforms.

The only really tricky part of setting up a triggered scope is the setting of the STABILITY and TRIGGER LEVEL controls. Short the probe leads together, and turn the TRIGGER LEVEL control to either end. Turn the STABILITY control up till the sweep is visible, then down just enough to quench it. This is the most stable and sensitive setting of the triggering system, so *do not* touch the STABILITY control any more during subsequent operation.

Next thing to think about is the *expected* amplitude of the voltage you're going to test. Take for example the 6.3-volt ac heater voltage. You'll want to set the vertical input attenuator (VOLTS/CM) to show a trace of reasonable height on the graticule; otherwise, the scope can't trigger properly. The 6.3 volts rms will cause a peak-to-peak trace of about 17.6 volts. With the VOLTS/CM switch set for 5, you'll get a trace over 3 cm high. If you're using a 10:1 low-capacitance probe, set the switch for 0.5 volt/cm. Always set this

switch before using the probe.

Next in order is to set the TIME/CM switch. The setting depends on the frequency of the dominant waveform you want to observe, and on how many cycles of it you want to look at. For the 60-Hz heater waveform we're using as our first example, set the TIME/CM switch to 10 msec. This setting will show five full cycles and part of another in the 10-cm-wide graticule.

In conjunction with the TIME/CM switch there is sometimes a MULTIPLIER switch, especially when the TIME/CM switch is a decade type (in steps of 10). If you want to look at fewer cycles of the 60-Hz signal, set the TIME/CM switch for 1 msec/cm. Since a 60-Hz sine wave takes almost 17 msec to complete a cycle, one cycle will extend well beyond the 10 cm of the graticule. Set the MULTIPLIER at 2, however, and you will have calibrated your graticule

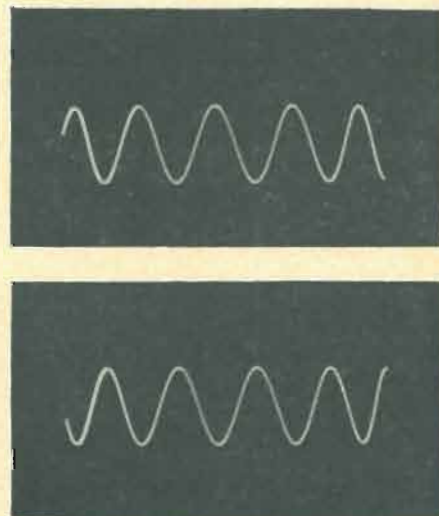

Fig. 4—Recurrent-sweep scope can sync on positive (a) or negative (b) half-cycles.



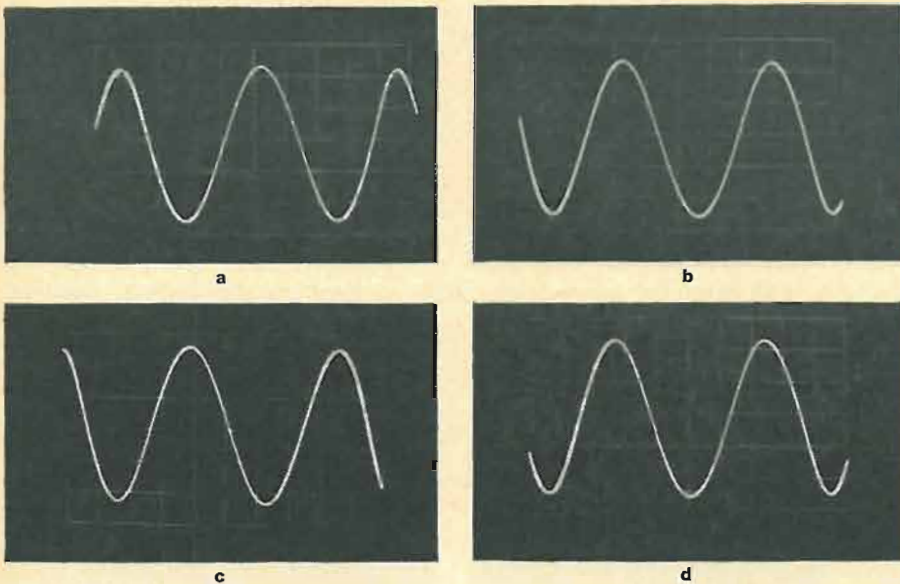

Fig. 5—Triggered scope can not only lock on (a) positive- or (b) negative-going waveforms but also at any level throughout the trace, as illustrated above by (c) and (d).

for 2 msec/cm. You will find one cycle of a 60-Hz waveform occupies about 8.4 cm of the graticule.

#### Settings for color troubleshooting

In the color receiver, you will be interested mostly in viewing video waveforms at either the horizontal-line or the vertical-field rate. Horizontal is by far the most useful—it is the only rate you'll use in chroma circuits. A horizontal line takes about 63.5  $\mu$ sec to complete. Consequently, if the TIME/CM switch is set for 10  $\mu$ sec, one line of horizontal information—a sync pulse, the associated blanking pedestal, color burst (if present), and one line of video information—will extend for almost 6.4 cm across the graticule. Move the MULTIPLIER to 2, and each cm of graticule will mean 20  $\mu$ sec; you will be able to see three full lines of horizontal waveform in the

10-cm-wide graticule.

On occasion, you may want to examine a small section of a video waveform—say, the color burst on its back porch of the horizontal sync pulse. You can use the expander or MAGNIFIER function of the scope. It has two positions: X1 or normal, and X5. Begin by setting the TIME/CM switch for 10  $\mu$ sec, and the MULTIPLIER at 1. Then merely switch the MAGNIFIER on (on most scopes a small warning lamp will light to remind you it is on). The sweep trace will expand to 5 times its former length, and you can move the HORIZONTAL POSITIONING control to look at the exact portion of the trace you are interested in. Be sure to switch the MAGNIFIER off and recenter the POSITIONING when you are through.

For viewing vertical-rate waveforms, the triggered scope may seem difficult to synchronize solidly. This is because the scope sweep tries to trigger on horizontal pulses too, since they are as tall in amplitude as the vertical pulses. Since it wants to trigger on the first pulse that reaches the triggering level, the triggering circuit finds it difficult to choose the right one. One way this is solved is by using external triggering. Just clip a lead from the EXT TRIGGER SOURCE pin to the vicinity of the vertical-sweep circuits in the receiver. Fig. 6-a, taken at the video detector, is synchronized with a lead clipped to the insulation of one vertical output transformer lead. Don't forget to turn the SOURCE switch to EXT. (And don't forget to turn it back to INT later for ordinary use.)

You can get a really good look at the vertical sync pulse by spreading it out with the X5 magnifier (Fig. 6-b). It was necessary to reposition the trace horizontally to see this portion of it.

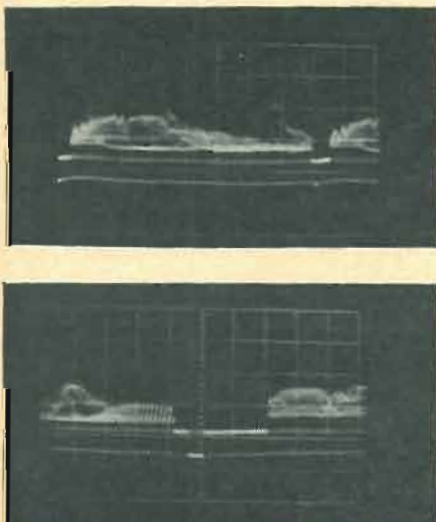

Fig. 6—Upper trace is normal width, bottom is expanded. External sync used.

#### When it doesn't work

After spending time teaching technicians how to use a triggered scope, I've found a few points that seem to be the biggest stumbling blocks. If you'll watch out for these pitfalls, you'll be able to teach yourself to run a triggered scope successfully.

The first problem usually is caused by inability to get a trace. If this happens to you, take these steps:

- (a) Temporarily turn up the STABILITY control. You should see a trace. If not, check the intensity and positioning controls.
- (b) With the STABILITY control still up and trace visible, turn the TRIGGER LEVEL to one end. Short the input probe to ground and turn the STABILITY control down slowly until the trace just barely disappears.
- (c) Recenter the TRIGGER LEVEL control. This is very important.
- (d) Turn the VOLTS/CM switch to its lowest position—.05 on my scope. Unground the input probe and touch it with your finger. You should get trace and vertical deflection. To see the trace better, set the TIME/CM switch to 1 msec.
- (e) Turn VOLTS/CM to approximately 1/10 the voltage you expect (if 10 volts p-p, set at 1; if 1 volt p-p, set at 0.1; etc.). Reconnect to your test voltage and adjust the VOLTS/CM switch so you have a trace height within the graticule.
- (f) Adjust TIME/CM for whatever waveform you're watching.

The other problem that crops up regularly is a trace that won't stand still but creeps or runs horizontally. I described this earlier in conjunction with viewing vertical-rate video waveforms. The trouble is caused by complex waveforms in which more than one frequency reaches the same maximum height or amplitude. In that case, even though you turn the TRIGGER LEVEL far from center, you finally go clear above the trace (thus blanking it out altogether) before you find a single peak to lock on.

The solutions to this problem aren't always simple, but they can be generalized by suggesting external sync as the best solution. In the case of video, an integrator can be used and an integrated video signal fed to the EXT TRIGGER input.

For viewing complex signals other than TV, there are other sources of trigger. Probably most often used is a very stable audio generator.

You now have enough information to do a capable job of troubleshooting color chassis with a triggered-sweep scope. Once you try it out and learn how to set up the controls, you'll find the triggered instrument much easier to use than any recurrent-sweep scope. You'll be as happy with it as I am. END



# Color Voltages Ain't Circular to Me!

Round and round or up and down—which way does the color signal travel?

By **STEPHEN KIRK**

COLOR MODULATION AND DEMODULATION are basically simple—it's the gosh-awful explanations that make it bewildering and as inscrutable as the genetic code. At least it seems that way to me.

After I had plodded through elucidations without number, I could easily have believed that a color demodulator is some kind of special beast that perhaps uses a vacuum tube with a circular plate and a cathode that sprays electrons into carefully calibrated slots every 30° to accommodate color-bar generators.

Now, I don't mind going around in circles (I've done it often enough), but it *is not* a circular voltage that, say, makes a picture-tube red gun conduct more or less. It's just a plain old up-and-down voltage that does it, the same as for any other tube grid. Up is positive, and down is negative.

The trouble is that engineers often use rotating vectors—those “circular” voltages with arrows in them—to make color modulation and demodulation more “understandable.” What they too often succeed in doing (for me, anyway) is making the clarification more complicated than the problem. It has often left me feeling that a demodulator must be something like a woman—necessary, but inherently baffling. That's why I'm telling you here about my “different approach.”

Color-television transmitters are modulated with up-and-down voltages. If the scene is redder, the output of the camera's red tube goes up. If a part of the scene is bluer, the output of the blue tube goes up. If the scene is magenta then both the red and the blue tubes put out more voltage.

At the receiver, these up-and-down signals are demodulated. If there is more red voltage for the red gun, the red on the screen will be brighter. When the blue is stronger, the blue gun will conduct more. If both guns conduct the same amount at the same time, the scene will be magenta or some shade mixing red and blue. That's what we see, and so the only important thing that is circular about color TV is the eyeball that's watching it.

Vectors would probably never have entered the picture if two carriers on different frequencies had been used for the color-difference signals, sometimes called R-Y and B-Y. But, to conserve space and bandwidth, the color engineers ingeniously used two carriers at the same frequency with separate modulation. A good explanation of how that's done (good, at least for electronics people) can be based on the electrostatically deflected CRT shown in Fig. 1. This shows how voltages at right angles to each other do not adversely affect one another.

If we put a certain voltage on plate A, the dot (beam) will move to position 1. If we remove this voltage and place it on plate B, the dot will move to position 2. Now if we put that amount of voltage on both A and B, the dot will move to position 3.

What's the point? The point is that the dot moved the same *upward* distance when the voltage was on both plates as it did when the voltage was on only plate A, and it moved the same *sideways* distance when the voltage was on both plates as it did when only plate B had

voltage. In other words, if we referenced the dot movement to zero (no voltage, dot at center) and measured the distance it moved either up or sideways, it's the same as far as either plate is concerned regardless of what's happening on the other plate.

That, in a nutshell is the basis for the theory (and it works) that two identical signals 90° apart can be modulated with two different sources at the same time with no complicated interaction. This sort of thing is what's done all the time with stereo cartridges that separate left channel from right with one needle in a single groove.

The stereo cartridge gets 90° or right-angle shift by mechanical means. You can get the same effect electronically by starting one sine-wave signal at a certain time and another just like it one-quarter of a cycle (90°) later (Fig. 2). This second signal is sometimes called a *quadrature* signal. The *quad* part of that word (they tell me) has to do with right angles, each of which is of course 90°. That's where the quad signal is—90° away from the first signal. The first signal is called *I*, for in phase—with itself, I guess.

Why all this talk about putting two signals close together? It has to do with saving bandwidth and making color compatible with black-and-white TV.

The color TV camera picks up nothing but R, G and B signals. (Yeah, I know they've got a new camera with a black-and-white pickup tube in it, but let's forget about it for now.) R, G and B are combined into a Y (luminance) signal that's 30% R, 59% G and 11% B. That's the monochrome, or compatible, signal that you see on a black-and-white receiver. It's also the starting point for the color picture on a color CRT.

You see, if they transmitted R, G and B on separate channels, there'd be no way for a black-and-white set to get a picture from a color program, without adding more circuitry. But the luminance signal worked fine. Now, to make a color picture, they needed additional color signals.

First, the color-TV engineers thought they'd transmit Y, R-Y, and B-Y. No need to transmit G-Y; since

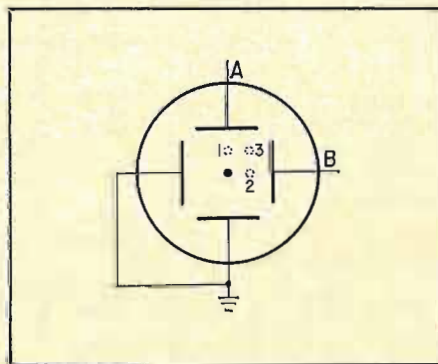

Fig. 1—CRT explains quadrature action.

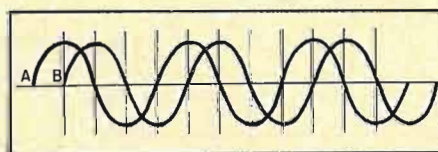

Fig. 2—Carrier B starts a quarter-cycle (90°) after carrier A, or in quadrature.



Y contains elements of all three colors, if you took R—Y and B—Y away from Y, all you'd have left would be G—Y. Okay—but it just so happens that they don't transmit all three colors with full bandwidth. There just isn't room within the standard 6-MHz television channel for such extravagance. Instead, the Y part of the color signal is transmitted with 4.2-MHz bandwidth (rather than 4-MHz, as with black-and-white), while one of the color-difference signals is transmitted with 1.5-MHz bandwidth, and the other, 0.5-MHz. Why? Just wait and I'll explain.

It so happens that the unmodulated or zero point of R—Y is around bluish-red and bluish-green. The zero point of B—Y is around reddish-green and yellowish-green. These are vital points.

Somebody found that you can paint a picture with only two colors (orange and a type of blue called *cyan*) and fool the eye into thinking it's a full-color picture, so long as you do this for *small* objects. When you get into large things, you gotta have all three colors. For the *really* fine details, like sharp edges of objects, or the checked pattern on a man's suit, you need only black-and-white information. The eye doesn't see color for fine details.

So the color engineers knew they'd have to transmit black-and-white with full 4.2-MHz bandwidth, and orange and

cyan with 1.5-MHz bandwidth, to accurately reproduce fine detail, and small objects in color. For large objects, they'd need all three colors, but this meant a bandwidth of only another 0.5 MHz, which was easy.

The black-and-white was no problem—they simply combined R, G and B into Y and used 4.2-MHz bandwidth. But to make orange and cyan with R—Y and B—Y, you'd have to transmit both with 1.5-MHz bandwidth, and there wasn't room. What to do?

They decided to shift the reference points of the two sets of color sidebands and they arbitrarily called the first one I—for in phase, as mentioned earlier. I is transmitted with 1.5-MHz bandwidth. The other they called Q—for quadrature; it has 0.5-MHz bandwidth.

Again to save bandwidth, the engineers used a single carrier for both I and Q signals. They split the carrier into two channels, delayed one 90° with respect to the other, and modulated the two with I and Q, respectively.

To keep from cluttering the total signal with beat frequencies, the 3.58-MHz carriers are removed before final transmission. To establish a sense of timing at the receiver, just a few cycles of the 3.58-MHz signal are sent out with the rest of the TV signal. It is this *burst* that locks in the locally generated 3.58-MHz carrier in the receiver. That ad-

justs timing in the demodulators for the main or I-signal carrier. The Q-signal carrier is then also redeveloped by delaying a sample of the I signal by 90°.

As we have already shown, you can have up-and-down color modulation on these two separate carriers without worrying about interaction between them. How can we recover these same two modulating voltages in the receiver? The secret, of course, is because we have re-created the two separated carriers in the receiver and have locked them in time with the transmitter. Now we can demodulate exactly what was modulated at the transmitter.

Demodulate a set of voltages in step with the first carrier, and you get a specific output. Then demodulate the same set of voltages in step with another carrier 90° later, and you get another specific output. In reality, then, you can take this modulated composite voltage and get two entirely separate outputs from it. That's how a composite color voltage can be transmitted without sending the carriers along.

There are several ways of actually converting the incoming video signal to R, G and B for the CRT. All present systems detect the Y signal (black-and-white video) in one or two stages, separate from the color stages. The circuit differences come from the methods of getting the color-difference signals.

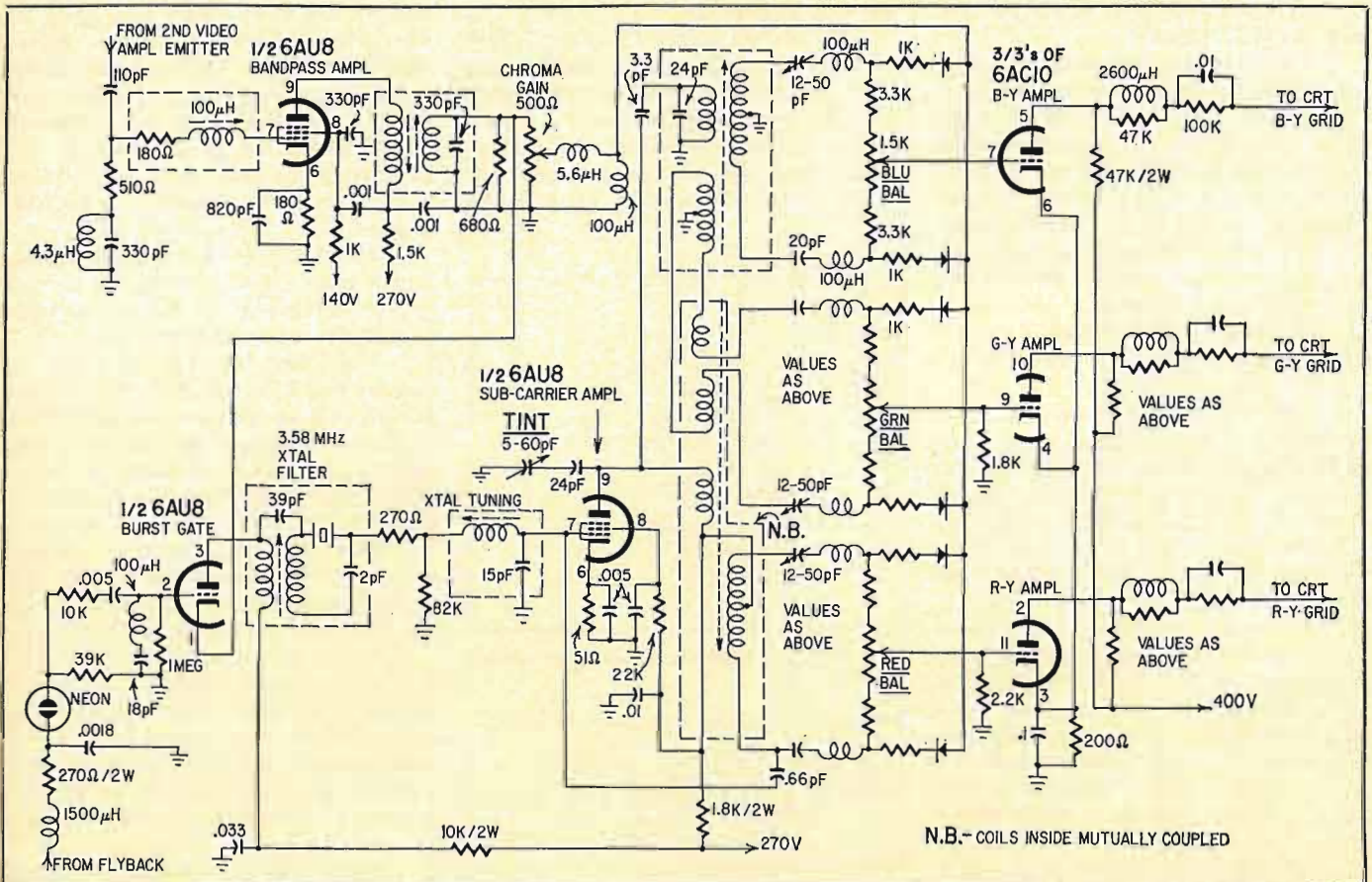

Fig. 3—G-E chassis CB uses one of the newest types of color demodulation, matrixing before detection.



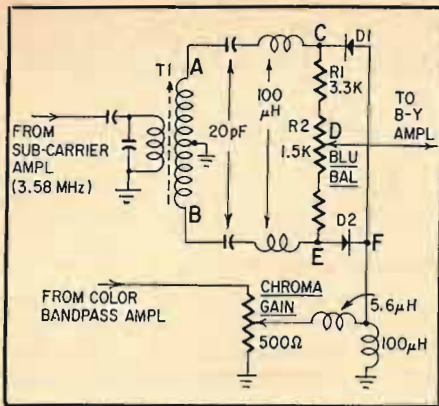

Fig. 4—B-Y detector in G-E KC chassis.

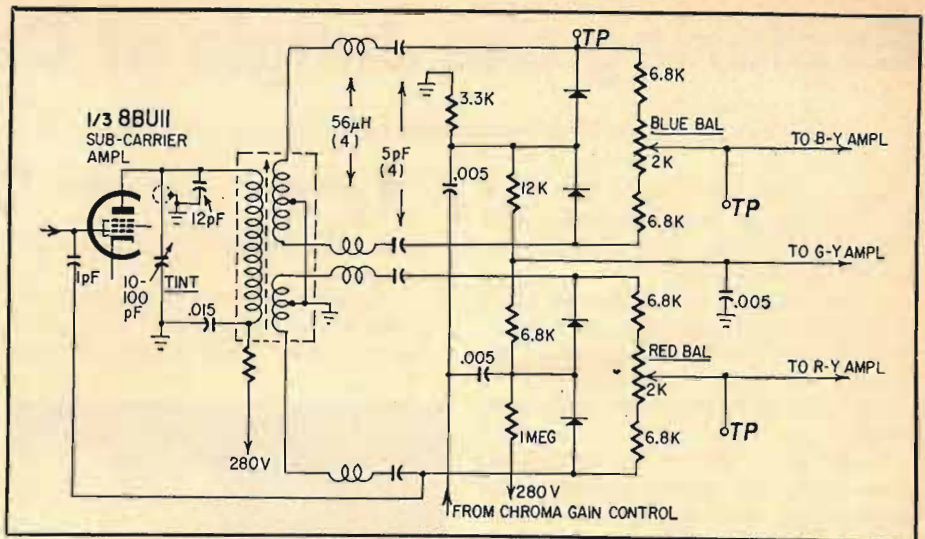

Fig. 5—Circuit of G-E Porta-Color uses two demodulators, with three outputs.

One way is to set up two demodulators, operate them on the I and Q reference points, combine their outputs in a certain manner to produce R and B. R and B are then combined and subtracted from Y to produce G.

Another way is to again use two demodulators, operating them on R-Y and B-Y references. By also using the Y signal, the demodulator outputs can produce R and B, as well as G.

A third method, used extensively now, is to employ still a *third* set of reference points, called arbitrarily X and Z. Their outputs are mixed differently from the previous examples, but the results are the same—R and B and, by using Y, G.

Engineers are ingenious, though (as well as baffling), and they have come up with another variation. Many receivers detect Y and the two color-difference signals first, then matrix the demodulated signals to produce R, G and B. Some newer circuits matrix color-difference signals *before* demodulating, usually by inductive coupling of three demodulators. Outputs are then some form of R, G and B.

This new arrangement is used by G-E in their KC and CB chassis.

Three essentially identical diode demodulators are used: one for B-Y, one for R-Y and another for G-Y. Fig. 3, the color demodulator circuit of G-E's "CB" chassis, will give you the idea. Obviously the signal from the color carrier must be of the right polarity. If there is *more* blue in the picture then we must have *more* positive voltage on the blue picture-tube grid. Getting the right polarity is simply a matter of connecting the diodes in the circuit correctly.

If we follow the signal through a single demodulator, we can see what happens (Fig. 4). Whenever the signal goes negative at the top end of T1's secondary, diode D1 will conduct. At the same time, the other end of the secondary is positive and, since D2 is opposite

in polarity from D1, diode D2 will conduct too. Because these two diodes are in opposition, the output at the center of R1-R2-R3 will be zero.

On the next half-cycle of 3.58-MHz signal, both diodes will be cut off. The voltage at the center of R1-R2-R3 remains zero.

So you can see that with a plain unmodulated (no color) 3.58-MHz signal applied to the diodes, the output is zero regardless of whether the diodes are conducting or not.

But let's suppose that, during the time when the diodes *are* conducting, a positive-going color signal arrives and is introduced between point F and ground.

Diode D1 will conduct more when this happens and diode D2 will conduct less. The two diodes now develop a positive voltage at point C and a more negative one at point E.

This means that during the time the diodes have been made to conduct by the half-cycle of the 3.58-MHz signal, a color-modulation signal will cause an up or a down output voltage. This can be amplified and used to drive the picture-tube grid voltage up or down. (Nothing circular here.)

On the next half-cycle of 3.58-MHz signal, though, both diodes are blocked and any color signal arriving at that time is disregarded by the demodulator.

We've now recovered one signal, let's say the B-Y. To recover the R-Y, all we need do is to build another demodulator and key it with our 3.58-MHz signal that is delayed by 90°. When the same composite color voltage arrives at this modulator, it will find a different zero-reference point, and the output voltage will represent only whatever was sent on the transmitter's quadrature carrier. In other words, these diodes are turned on at a different time—90° or one quarter-cycle later—so they see only the modulation on the quadrature carrier.

To get a G-Y signal, which is derived by using a portion of the inverted

R-Y and the inverted signals, G-E elects in their big-screen models to inject a portion of both carriers in the correct phase. This is how the green difference signal is recovered. In other words, they matrix *before* they demodulate. Most other companies choose to use only two demodulators and then matrix after demodulation to recover the G-Y signal.

In Fig. 5 is a portion of G-E's 11-inch Porta-Color set, which uses a G-Y voltage developed from between the back sides of the diode B-Y and R-Y demodulators. I guess you could call this matrixing *at* demodulation.

Other color demodulators work essentially the same. The 3.58-MHz signal is allowed to "key on" a tube or diode at the right time and in the right polarity. The resulting output is a simple up or down voltage, moving up and down in step with whatever color appears in the scene being televised. Thus it turns the color guns in the picture tube on at the right time to make the picture redder or less red, bluer or less blue—or any one of the combinations of colors in between. All these combinations of colors are in reality then mixed and matrixed by our brains.

Color signals are AM—once the carriers have been recreated at the receiver, the modulation can be detected just as with any other AM signal. At the transmitter, they put two signals seemingly into one by two carriers of the same frequency (3.58 MHz) but 90° apart in phase. At the receiver, that's how they have to be recovered. And this is the reason color demodulators are sometimes called synchronous detectors; they have to detect *only* in sync with their respective carriers. It makes no difference whether you call these reinserted carriers I and Q, R-Y and B-Y, or X and Z. The result is the same: Up-and-down voltages drive each CRT grid—up and down, not around in circles!

END



# Exploring the Jungle of Color Troubles

The trail leads down winding paths past hidden traps and misleading signals. Without logic, you'll be lost

"WILL YOU PLEASE SEND A MAN OVER this morning to check my color TV? The color seems to come and go, and sometimes it's terrible."

How many times have you come to the shop bright and early, to be greeted by a call like this? Sometimes you wonder where to start, there are so many components that could cause poor color.

Start at the source. The signal originates at the TV station, travels to the antenna, into the receiver, and eventually arrives at the CRT (same sequence for black-and-white or color). Why poor color? The station (or network) may be having color problems. Check this possibility first—try a known-to-be-good receiver at the shop before you go to the customer's house. If it shows a good picture on the station, you can assume the signal's okay to the antenna.

Next, suspect the customer's antenna. Except in high-signal locations, an indoor antenna isn't much good for color. Neither is an attic model—one day the color is there and the next it's weak or gone. A broadband antenna is a must. It's also got to be directive to eliminate multipath reception, which is the enemy of color burst. All this applies especially to the uhf color antenna. Often, you'll need a good four-stacked broadband model, and it should be on the roof.

The next link in the chain is the lead-in. Four good varieties are available: The round polyethylene-filled lead does a good job in close-in locations. Another local-fringe lead is a heavy-duty 300-ohm lead three times as thick as the old flat version. If interference is a problem, you can use a 72-ohm coax with transformers at each end, or a new 300-ohm shielded lead.

With the signal clean up to the antenna terminals, it's time for a look at the front end. Be sure the tuner and video tubes test good. Also see that all tubes are in their proper sockets. It's pretty easy for someone to carelessly interchange tubes.

This happened to me recently with an Admiral 1G11 chassis. The first tube should be a 6JH6, but a 6GM6 was there instead. In the second stage I found a 6GM6 which is the correct tube. In this case, the receiver had a good black-and-white picture, but was weak on color—especially on fringe-area stations. A lot of valuable time was lost on this job, simply because I *assumed* the tubes were in their proper sockets. *Never assume anything!* Substitute and check those tubes from the first rf through the chroma section. Be sure to

By HOMER L. DAVIDSON

replace any tube shields removed while testing tubes.

At this point, you've checked the obvious preliminaries, and so long as the receiver shows good black-and-white

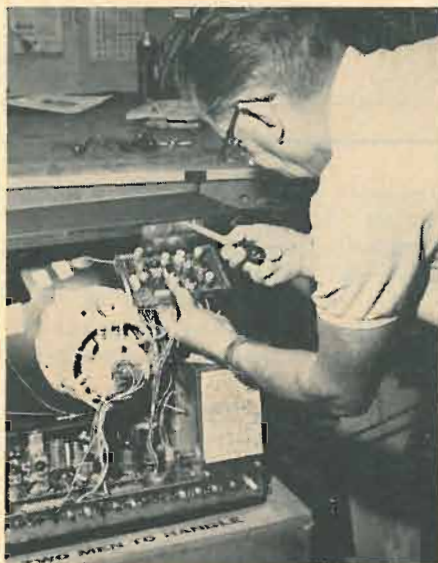

Most color receivers have convergence-board mounting that's handy for setup.

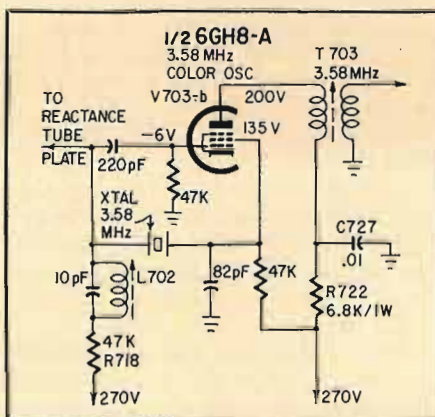

Fig. 1—The 3.58-MHz oscillator should be the first chroma stage that you check.

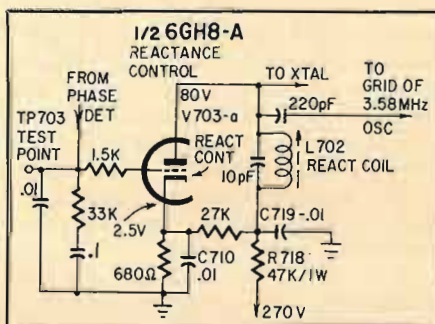

Fig. 2—Another possible trouble source.

but defective color, you can safely dig into the sections used for color only.

## Chroma section

It's a good idea to go right to the color-oscillator stage. Check the tube if there's no color at all. The 3.58-MHz oscillator is a crystal-controlled circuit whose frequency is varied slightly by a reactance tube. In older receivers the oscillator was a 6U8. Later, the 6EA8 came along; it did the job better. Now most color receivers use the pentode section of a 6GH8-A. Plug in a new tube to see if the oscillator will take off. Still no color? Take a voltage reading on the oscillator grid—it should be somewhere between  $-6$  and  $-10$  when a color program is being received.

A weak or intermittent 3.58-MHz crystal will cause poor or intermittent color (Fig. 1). You may find the color seeming to "breathe in and out" on the screen. This was found in early production runs of Admiral's G11 chassis. Besides color drifting in these models, you'll notice the fine tuning is critical. It's even worse on uhf, where color is more difficult to tune.

Again referring to Fig. 1, if C727, a .01- $\mu$ F bypass capacitor, has any leakage there will be no color and a correspondingly low voltage at the 6GH8 plate. A burned condition or a decrease in resistance of R722 will cause weak or no color with a very, very low grid voltage.

It's also possible that the reactance-tube circuit is at fault (Fig. 2). In some cases a slight adjustment of L702, the reactance plate coil, will start the circuit oscillating. Turn no more than a half turn of the small core, and do this only when voltage checks have failed to show up any oscillator trouble.

An RCA CTC16E chassis carried a slow-warmup complaint—20 minutes to get color from a cold start. While color would generally hold, it dropped out intermittently. When I arrived to check the set the owner, of course, had it running and there was plenty of color. I changed the color oscillator and hoped for the best. He called me at eight-thirty the next morning—the trouble was back. I told him to turn off the set, I'd be out in a couple of hours.

Sure enough, there wasn't a sign of color on the screen; I replaced the burst-and bandpass-amplifier tubes. No luck. Then I replaced *all* the tubes on the color board. Even the color-killer setting was turned up full. After about 20 minutes color came rolling in. I found I could make color come and go by push-



ing and prodding on the chassis.

The chassis was pulled and checked; all connections seemed tight. Never had trouble before with 3.58-oscillator transformer connections, and these seemed good. Finally, I found one end of C727 (Fig. 1) sticking through the etched board and lacking solder. A slight movement of the etched board, caused by normal operating heat, would make the contact. If C727 opens up, there's no color.

If you get into the 3.58-MHz stages at all, it's well to check alignment. Follow the factory afpc alignment instructions. Most RCA 3.58-MHz oscillator alignments (in the CTC16, for example) can be done in the following manner:

Connect a color-bar generator to the receiver antenna terminals. Adjust the receiver for normal color reception. Set the tint control to the middle of its range and the killer threshold control fully counterclockwise. Place a jumper from pin 1 of V702 (the burst-amplifier cathode) to ground. Connect a vtvm in series with a 470K resistor to pin 1 of V705A (the phase detector). Now adjust T703, the 3.58-MHz transformer, for maximum reading on the vtvm. If the 3.58-MHz oscillator is not running, adjust reactance plate coil L702 to start the oscillator.

When the reactance control stage isn't working correctly, color will run in waves through a black-and-white picture. The reactance control tube is in parallel with the tank circuit of the 3.58-MHz oscillator so that the signal produced in the oscillator will either lag or lead the signal produced in the tank circuit. In the RCA CTC16 chassis, half a tube is the oscillator and the other half is the reactance tube.

In oscillator or reactance-tube troubles, first replace this tube with a new one and then test the old one. If C719 or the reactance tube (Fig. 2) shorts, R718 gets real warm and its resistance decreases to the point where color sync is lost.

If cathode capacitor C710 has any leakage the result is the same. If C710 opens up, however, you can't tell a lot of difference in a color picture.

To align the reactance plate coil (L702) correctly, hook a color-bar generator to the antenna terminals, and adjust the receiver for normal color reception. Ground the reactance-tube input; most RCA receivers have a base wire protruding through the etched board (TP703) with a short ground clip (Fig. 3). Adjust the reactance plate coil (L702) to zero-beat with the 3.58-MHz oscillator. Watch the screen and adjust the slug so the color bars stand still or merely drift slowly across the screen.

The burst amplifier, which is keyed

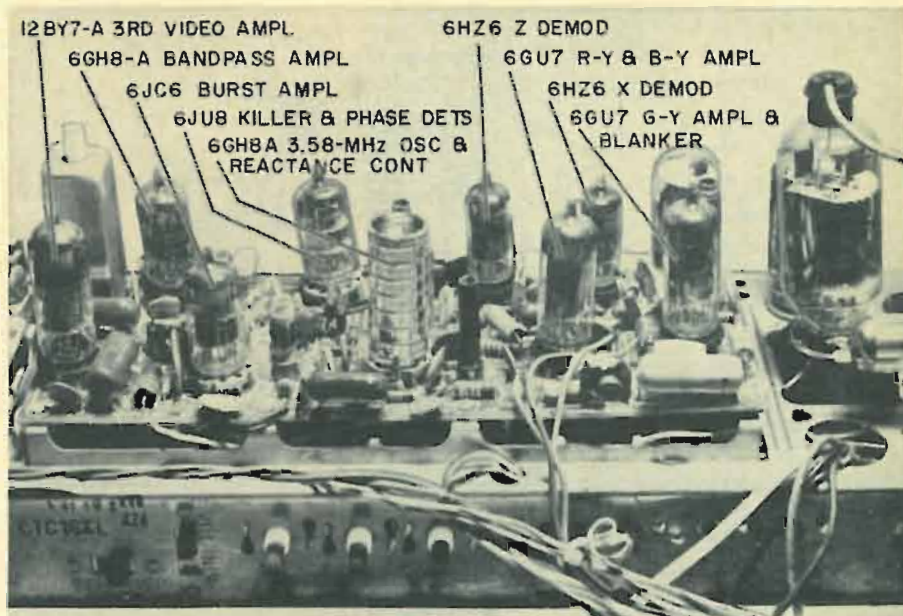

Here's where the tubes are found in the chroma section. Compare with Fig. 3 below.

into conduction by a horizontal pulse, amplifies the 3.58-MHz burst riding just after the horizontal-sync pulse. A weak burst-amplifier tube, therefore, will produce a poor color picture. Referring to Fig. 4, if cathode bypass C706 shorts, the tube will draw heavy current. You will notice on most of these tubes that the plate and screen voltages are high. The cathode will vary from 22 to 55 volts on a color broadcast. A change of bias on the burst-amplifier

tube results in poor color. Also, if R706 amplifies the 3.58-MHz burst riding just after the horizontal-sync pulse. A weak burst-amplifier tube, therefore, will produce a poor color picture. Referring to Fig. 4, if cathode bypass C706 shorts, the tube will draw heavy current. You will notice on most of these tubes that the plate and screen voltages are high. The cathode will vary from 22 to 55 volts on a color broadcast. A change of bias on the burst-amplifier

tube results in poor color. Also, if R706 burns or decreases to about 1,000 ohms, the tint (or hue) of the color picture will shift toward green. Likewise, if R705 decreases to 1,000 ohms, there will be no color. Even if R705 only drops to half value, color becomes weak (perhaps no color in extreme fringe areas).

An easy pitfall to avoid: If you go to a customer's home to troubleshoot a weak-color case, be careful how you use a color-bar generator. Too much signal

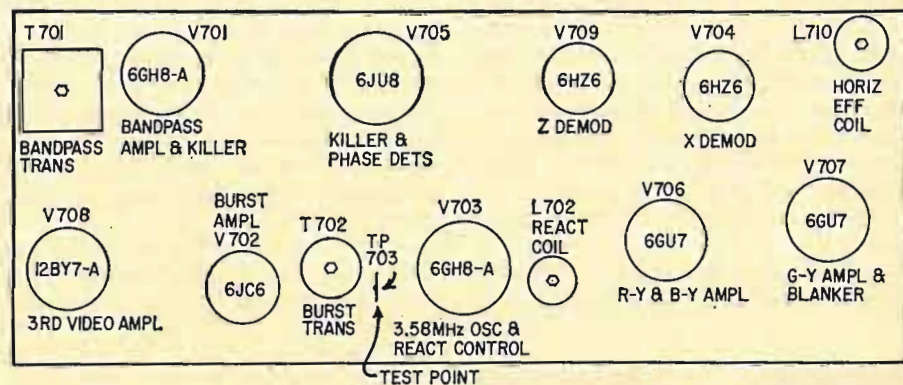

Fig. 3—Top view of chroma printed-circuit board shows the location of big components.

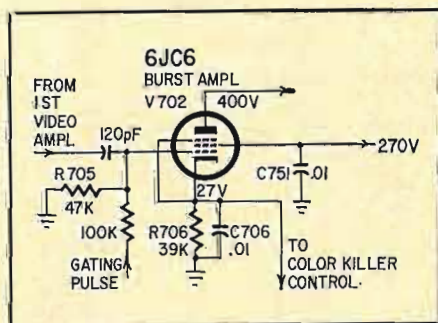

Fig. 4—The burst-amplifier stage must operate properly for correct color sync. Cathode voltage depends on signal level.

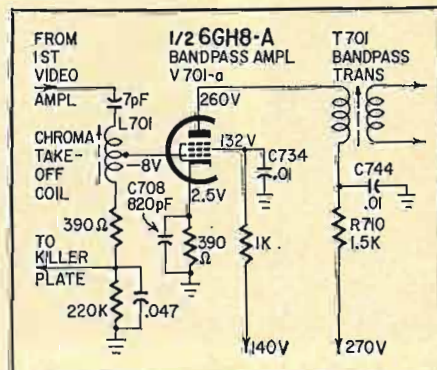

Fig. 5—The chroma bandpass amplifier.



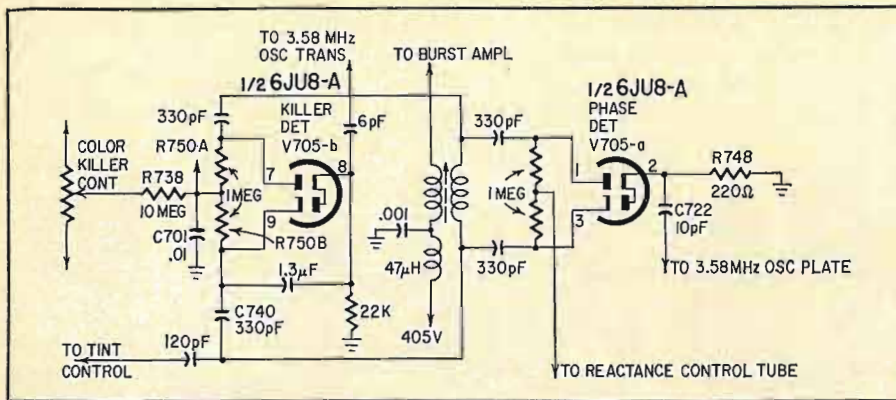

Fig. 6—These four diodes, all in same tube, detect presence and phase of color burst.

from the generator will make the receiver work okay. But the customer doesn't want to watch your generator! Use the station signal—even though it's weak—to troubleshoot the receiver.

The bandpass amplifier amplifies both color and sideband frequencies (Fig. 5). Do not attempt to align the chroma takeoff coil or bandpass amplifier without a scope and a marker generator. If there's a loose or poor solder joint on the chroma takeoff coil, you'll get intermittent or poor color. If cathode capacitor C708 shorts, normally pink flesh tones will become reddish. You'll also find tint control regulation is poor.

If screen bypass C734 leaks or shorts, color will be weak or nonexistent. If C744, the plate-supply bypass shorts, there will be no color in the picture and the color screen will become dark. If you find a shorted C744, be sure to check R710, because the short will draw an overcurrent through this resistor. This may possibly change its resistance. A decrease in R710's resistance will not affect color much, but an increase in resistance can result in no color.

The color phase detector (V705A) compares oscillator phase with incom-

ing burst phase. This detector supplies a correction voltage to keep the reactance tube in sync with the station signal. Color may be missing or out of lock if there is a weak or dead phase-detector tube. The color bars will then roll up or down the screen.

Referring to Fig. 6, if C722 shorts there will be no color, and B+ will appear at pin 2 of V705A. R748 will get quite warm and smelly. Check or replace the phase-detector tube when the color will not lock in.

The color killer, of course, keeps color out of a black-and-white picture when a color program is not being received. If there's no color on a color program, check the setting of the killer control. In fringe areas it may be wide open. In other cases the best color may be when the control is set to midrange. This is true in some Admiral 23-inch receivers. Also, color may be fine on a strong signal. But, on another channel, the control will have to be set higher to receive good color. Be sure and check out each channel individually, for good color, and set the color killer control accordingly. (You may have to compromise here.)

Refer again to Fig. 6. R738 can often cause a lot of color troubles. If the killer control opens up there will be col-

or in the picture at all times. When capacitor C701 shorts out, color will become weak, and the killer control will act like a regular contrast control.

In the killer detector circuit, R750A and R750B are a balanced pair. If either changes resistance you'll get weak or no color. If C740 shorts it will cause poor or weak color, and a shifting of tint in the picture.

The two demodulator circuits in a color receiver must be capable of both amplitude and phase detection of color signals. Naturally, these stages can cause poor color. A weak X-demodulator tube will cause poor or weak red color in the picture, a weak Z-demodulator tube, poor blue. Many times coupling capacitors C726 and C731 (Fig. 7) will leak or short, placing B+ on the color-amplifier grids. Sometimes the 3,900-ohm demodulator plate-load resistors will become hot and decrease in resistance. If either of the coupling capacitors (C731-C726) becomes defective, be sure to check R723A and R723B for correct values. A change in resistance here will show weak color on the screen.

The R-Y, G-Y and B-Y amplifiers tie directly to the control grids of the CRT. Any change in the tubes will change both the color and black-and-white picture. If the screen is all green on a black-and-white picture, check the R-Y amplifier tube and circuits. An all-red picture will be caused by a defective B-Y amplifier tube.

If C731 (Fig. 7) shorts or leaks there will be a greenish picture. A high B+ voltage will be on pin 2 of V706A, causing the R-Y amplifier to pull heavy current. R728, a 270-ohm cathode resistor, will burn and change resistance.

Capacitor C726 can cause similar action, producing a reddish color on the screen. It is always wise to change both capacitors, even though only one goes bad. Also change the common cathode resistor R728 and the plate resistor of each demodulator tube whenever you suspect overcurrent trouble.

When a customer complains of the picture being too blue or too green, check the color-amplifier tubes and circuits. A defective color CRT can also change the tint of a black-and-white picture. This happens when the tube ages—especially the older-model CRT's. Use a good CRT tester to check out any picture tube troubles.

It really isn't too difficult to troubleshoot color, if you progress logically through the set, function by function, stage by stage. Don't skip any links in the chain from the station signal to the CRT screen. And don't assume that something is okay just because it's supposed to be. Be skeptical, and you'll find the trouble. END

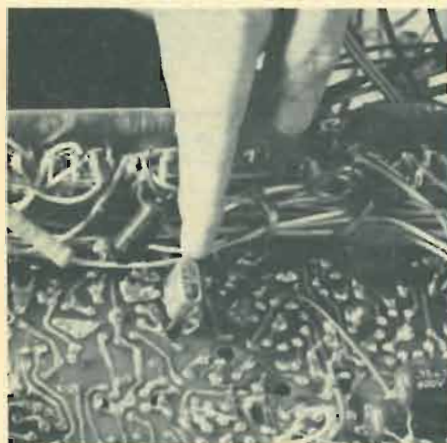

This 3.58-MHz crystal is in the grid-cathode circuit of the reference oscillator.

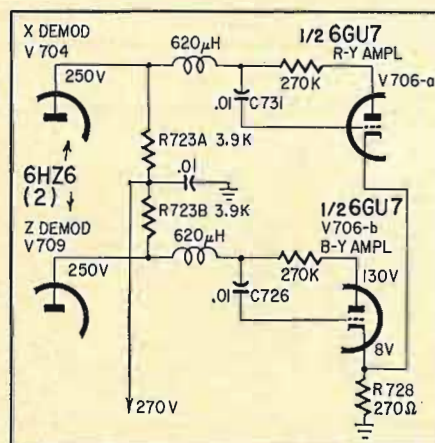

Fig. 7—Color-difference demodulators and amplifiers divide incoming chroma signals.



# The Development of Color-TV Signal

Luminance, chrominance, hue, saturation, and burst—they're all necessary to make a color picture

A BEAUTIFUL GIRL IN A COLORFUL costume is lounging in an attractive room. Would you like to have her lounge in *your* living room? Now it is possible—by way of color television. It takes but the flip of a switch, but this is no indication of the hours of mathematical development which went into this very complex system. The telephone was remarkable—the radio outstanding—television was a masterpiece—but *color* TV is an absolute miracle.

How does this miracle occur, and just what goes into the signal which finally brings the beautiful girl into your home? First of all there must be a color camera in the TV studio. It is much like a black-and-white camera except that it is really three cameras in one. There are three pickup tubes, each with a colored filter in front of it—red, blue and green. (Some cameras use a fourth tube for straight black-and-white, but this is not necessary to produce color. The resulting signal looks the same on the oscilloscope as that from the three-tube camera.)

The signal from each tube is regular video, just as in a monochrome camera. The tube with the red filter (we'll call it the red tube) sees only red, and the red components of other colors. The green tube sees only green, etc. We *could* send the signals from each of the tubes directly to the transmitter, and thence to your receiver. But this would require more than 12 MHz of broadcast channel, and since each channel is limited to 6 MHz, a different method must be used. The three signals are instead processed in a unit called a colorplexer or encoder (depending upon the manufacturer).

To visualize what is happening we must think about a few things first. You know what a conventional black-and-white signal looks like. At horizontal line rate an oscilloscope shows sync and blanking (including front and back porch) and video (see Fig. 1). This signal produces the brightness we see on a b-w receiver. It is called the *luminance*

By MILTON A. SIZER

signal. In a color transmission we also have the same luminance signal, but along with it (superimposed as far as the scope picture is concerned) is the color information called *chrominance*, which is all occurring at 3.58 MHz (nominal). On the scope it gives a

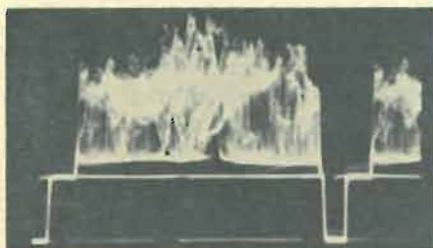

Fig. 1—Oscilloscope display of a black-and-white television signal at horizontal rate.

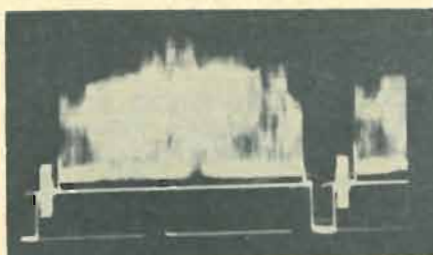

Fig. 2—Same display as Fig. 1, but this is a color TV signal complete with burst.

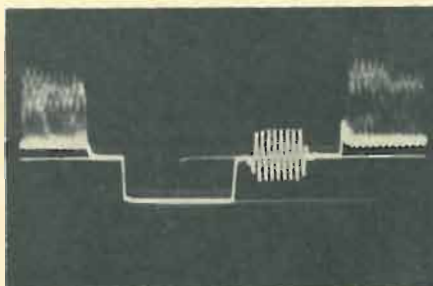

Fig. 3—Expanded scope trace of Fig. 2 shows details of color burst on back porch.

“fuzzy” appearance to an otherwise rather “clean” signal (Fig. 2)

In addition, something new has been added to the back porch. It is a burst of 3.58 MHz (8 or 9 cycles worth), called the “color burst” or “reference burst” (Fig. 3).

Let us see what is the makeup and purpose of each of these new signals. It is necessary for us to be able to combine a lot of information at the transmitting end, and then separate it all at the receiver. In black-and-white, brightness is the only variable, but in color, along with brightness, there is hue (that's the color—red, yellow, pink, aqua, etc.), and saturation (the intensity of the color—pale red, deep red, etc.). Even hue itself is the result of many combinations of the original red, blue and green signals, so you can see that many variables must be combined in what is called chrominance.

You are familiar with the method of transmitting a signal by means of amplitude-modulating a sine-wave carrier of steady frequency. Recently a method was discovered of modulating two carriers differing in phase, mixing them, and then at the other end unmixing them and demodulating each. This saves considerable space in the electromagnetic spectrum. In the color-TV system the 3.58-MHz subcarrier is divided into two such carriers differing only in phase (by  $90^\circ$ ). Picture a steady sine wave at 3.58 MHz. Now picture an identical signal, but shifted by  $90^\circ$  (see Fig. 4).

When properly modulated by the signals from the red, blue and green tubes, these carriers become known as I and Q, respectively. (I stands for *in* phase, and Q for *quadrature*, or  $90^\circ$  out of phase with I. Actually the I signal is not in phase with anything in particular, but is used as a reference for the Q-signal phase.)

A lengthy, although not difficult, mathematical derivation (which can be presented at a later date if there is a call for it) shows us how to modulate



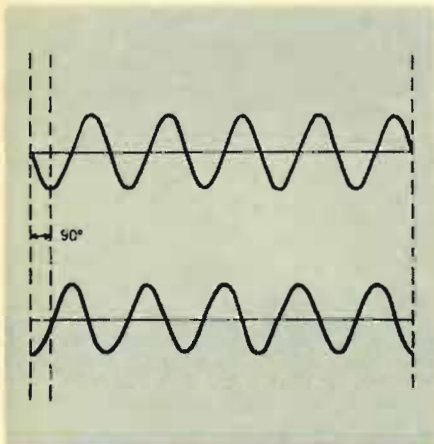

Fig. 4—Two continuous sine waves, of same frequency, with 90° phase difference.

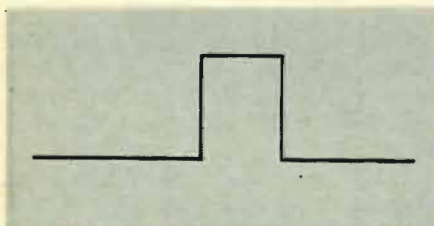

Fig. 5—Pure red output from red camera tube, when scanning all-red object in scene.

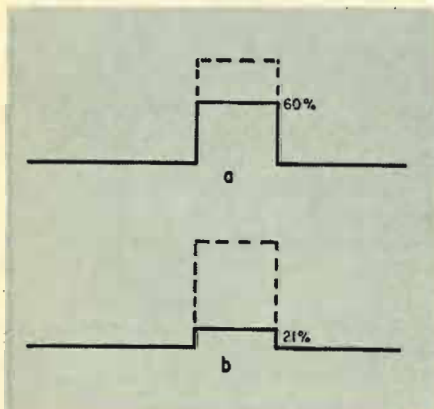

Fig. 6-a—The I signal takes 60% pure red. b—The Q signal takes only 21% pure red.

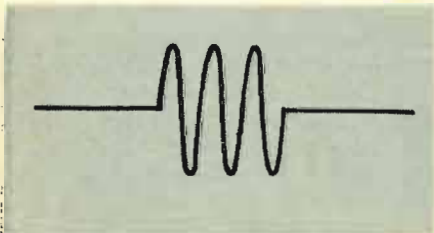

Fig. 7—The I signal after modulation by the red camera signal shown in Fig. 6-a.

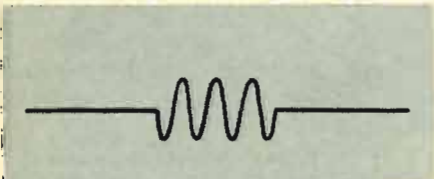

Fig. 8—Q signal after being red-modulated (Fig. 6-b) is still 90° out of phase with I.

the two carriers so that they will produce a usable chrominance signal. Here is the result of that derivation:

$$I = 0.60R - 0.28G - 0.32B \quad (1)$$

This means that the red signal is passed through a resistor matrix which reduces it to 60% of normal, producing 0.60R. The green signal is matrixed down to 28%, and then sent through an inverter stage to make it negative, producing  $-0.28G$ . The  $-0.32B$  is similarly produced. These three signals are then added electronically and the sum used to modulate the I portion of the divided carrier.

The Q carrier, differing in phase by 90° from I, is modulated according to the equation:

$$Q = 0.21R - 0.52G + 0.31B \quad (2)$$

In the modulation process, using balanced modulators, the carrier is suppressed and only the sidebands remain. One modulator stage processes the I signal, while another handles the Q signal. These two sets of sidebands are added together to produce the chrominance signal. This sum is also a 3.58-MHz signal containing all the needed information regarding color in the original scene. This is now added to the luminance signal (which will be discussed later) and the color signal is complete, except for the color burst on the back porch. An illustration of the formation of I and Q and the addition of the two are in order here.

The beautiful girl we've been talking about is wearing a red dress. Just for convenience, let us substitute a vertical red bar against a black background for the beautiful girl in the red dress. The output of the red tube would look like Fig. 5 on a scope. The output of the green and blue tubes would be zero in this area.

Equation (1) for I calls for 0.60R (green and blue are zero). Refer to Fig. 6-a. Equation (2) for Q calls for 0.21R (green and blue are zero). Refer to Fig. 6-b. The 60% signal, through a doubly balanced modulator, modulates one carrier, suppresses the video and carrier itself, and results in the sidebands only (I signal—see Fig. 7). The 21% signal modulates the carrier which differs in phase by 90° (Q signal—see Fig. 8). The I and Q signals are now added together, as shown in Fig. 9. Note that each signal has been spread out horizontally for clarity.

The final result is a sine wave of 3.58-MHz (nominal) frequency, with a new phase all its own. In this case red is illustrated. If another color were used, such as yellow or brown or pink or turquoise, other phases would result, since not only red but also portions of blue and green would be used.

Red in a picture will always have

the phase relationship to I and Q shown in Fig. 9. All other colors will have slightly different phase relationships, but always the same for any one color. A phase chart can be constructed (Fig. 10) representing all the colors in their phase relationships to each other. Note that red is of slightly different phase than the I phase (20°), but quite different than that of Q (70°), corresponding nicely to Fig. 9.

Since the carriers have been suppressed for transmission, they must be reinserted at the receiver, to separate the original I and Q signals and then to demodulate them. (This is done by sideband suppressed-carrier theory, a topic too lengthy to cover here.) However, these carriers must be reinserted in the same phase relationship with respect to the colors as the original carriers at the broadcast station. In the receiver there is a very accurate 3.58-MHz oscillator which needs only a reference phase to lock to, in order that it can be reinserted as a carrier. This reference is a small burst of 3.58 MHz on the back porch of every horizontal blanking period, sent by the station in exactly the proper and desired phase relationship to the colors.

For various reasons related to the mathematical derivation mentioned above, the I phase is 57° away from the reference burst, and the Q phase 147° from the reference burst, at the transmitting station. The receiver oscillator locks on this burst, and is then delayed 57°, at which time it exactly duplicates the original I signal. Using a couple of modulators acting this time as synchronous detectors, this reinserted I-signal carrier allows the I modulation to be retrieved while canceling Q modulation.

At the same time, a 90°-shifted 3.58-MHz sine wave is combined (in a different set of synchronous detectors) with the same signal, and the Q modulation is removed while the I is canceled. This sounds complicated (and it is) but the net result is this: Three different color video signals are combined to produce I and Q signals which, after transmission, are recovered in the receiver. How they are now reconverted into three primary colors will be taken up shortly.

So far we have completely ignored a very important part of the total color signal. It is the black-and-white portion, or the luminance. If a fourth pickup tube is used in the camera, this luminance signal is easily obtained. However, if a fourth tube is *not* used, the luminance signal (sometimes called the Y signal, or in other literature the M signal, for monochrome) can be obtained in a manner similar to the I and Q signals. This process is given by the following equation:

$$Y = 0.30R + 0.59G + 0.11B \quad (3)$$



These values of red, green and blue were selected because of eye sensitivities to various colors. This particular combination produces a signal which results in a proper gray scale in a black-and-white receiver. It is *not* used to modulate a carrier, but remains as pure video. This Y, or luminance signal, is transmitted right along with the I and Q sidebands, or chrominance signal (see Fig. 2).

In a black-and-white receiver only the Y signal is viewed, since there are no chrominance processing circuits. However, in a color receiver, the Y signal also plays a very important part. Whether we like it or not, we will now have to do a little mathematics. After all, the receiver performs this math, so we ought to be willing to do it too!

Using inverter and adder stages as well as resistor matrices, the receiver performs the following mathematical steps: (Remember now that we have a 3.58-MHz sine wave for I and a similar-but-90°-displaced sine wave for Q.)

If we take 96% of the I amplitude and add it to 62% of the Q amplitude we end up with a signal called R—Y.

Mathematically stated:

$$R-Y = 0.96 I + 0.62 Q \quad (4)$$

Similarly,

$$B-Y = -1.10 I + 1.70 Q \quad (5)$$

and

$$G-Y = -0.28 I - 0.64 Q \quad (6)$$

Now we have three signals: R—Y, B—Y and G—Y. If we add Y to each one in three adder stages immediately preceding the color tube, and feed right into each of the grids, we get:

$$R-Y+Y = R \quad (7)$$

$$B-Y+Y = B \quad (8)$$

$$G-Y+Y = G \quad (9)$$

Thus our three original colors have been restored, each in its entirety, and

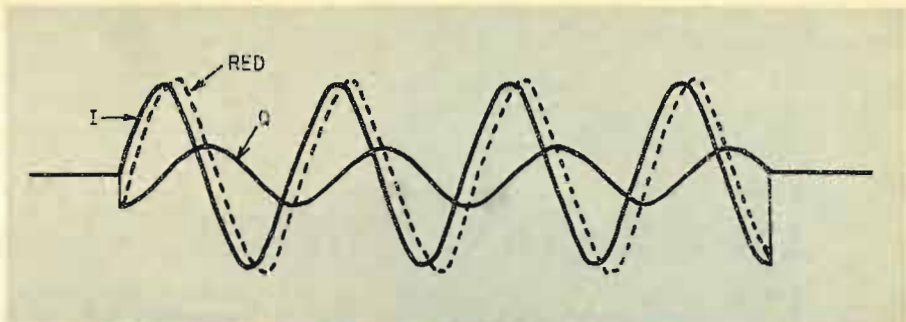

Fig. 9—Addition of I and Q signals (all-red modulation) produces dashed-line waveform.

produce a full color picture on the face of the picture tube.

The actual signal that you see on an oscilloscope really consists of the normal sync and blanking of a monochrome signal with the addition of the color burst on the back porch. The video contains not only mono information (luminance) but also color information (chrominance) which is a combination of the I and Q signals. Each color from the original scene (not just red, blue and green) is represented in the chrominance as a 3.58-MHz sine wave with a definite phase relationship to the reference burst on the back porch. When the viewer switches from one TV channel to another, the local 3.58-MHz oscillator in the receiver immediately locks onto the new reference burst so that the correct colors are assured—provided the station is transmitting colors in the proper phase relationship to the burst—and provided further that succeeding pieces of equipment do not shift this relationship by any one of several possible discrepancies.

If a difference in flesh-tone hue is noted when switching from station to station, it is a sure sign that camera chains or tape machines in one or both stations are not aligned perfectly, or that all discrepancies in equipment have not been entirely eliminated. Particularly in video tape reproduction there are nu-

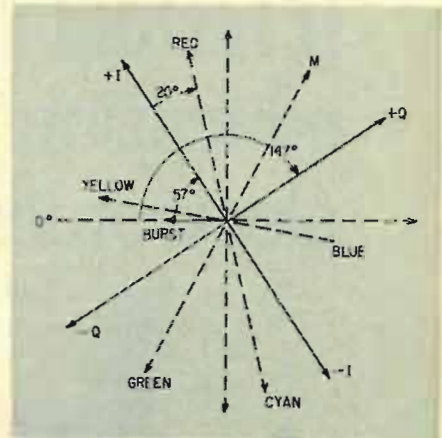

Fig. 10—This phase chart shows how the various colors relate to I and Q references.

merous possibilities for errors, and even with constant vigilance the results are not going to be perfect. Transmitting equipment and alignment also varies from station to station, and even from day to day in any one station.

But after all, that is why there is a phase (hue) control in the receiver—to counteract some of the discrepancies in the transmission of the signal. Unfortunately there is so far no sure method of counteracting these problems at the receiver, but some day the problems at the broadcast station will one by one be minimized. END

## WHAT'S YOUR EQ?

Conducted by E. D. CLARK

Two puzzlers for the student, theoretician and practical man. Simple? Double-check your answers before you say you've solved them. If you have an interesting or unusual puzzle (with an answer) send it to us. We will pay \$10 for each one accepted. We're especially interested in service stinkers or engineering stumblers on actual electronic equipment. We get so many letters we can't answer individual ones, but we'll print the more interesting solutions—ones the original authors never thought of.

Write EQ Editor, Radio-Electronics, 154 West 14th Street, New York, N. Y. 10011.

Answers to this month's puzzles are on page 99.

### Resistor Network

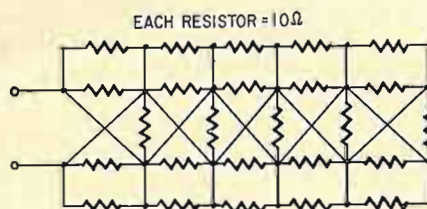

Another insomniac's  $R_T$  nightmare. Forget about Kirchoff's laws and loop-circuit calculations, though. Study the diagram carefully for about 30 seconds.

What's the total resistance at the terminals?—Dennis Howard

### Light Switching Circuit

Either one or both of the lamps in box B may be turned on by throwing either one or both of the switches in box A. In normal electrical work, this hookup would require three conductors between the boxes, not two, as shown.

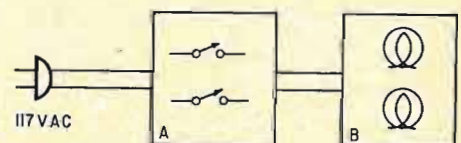

What's inside the boxes and how is everything wired?—Jim Wilhelm



**“He’s a good worker.  
I’d promote him right now  
if he had more  
education in  
electronics.”**

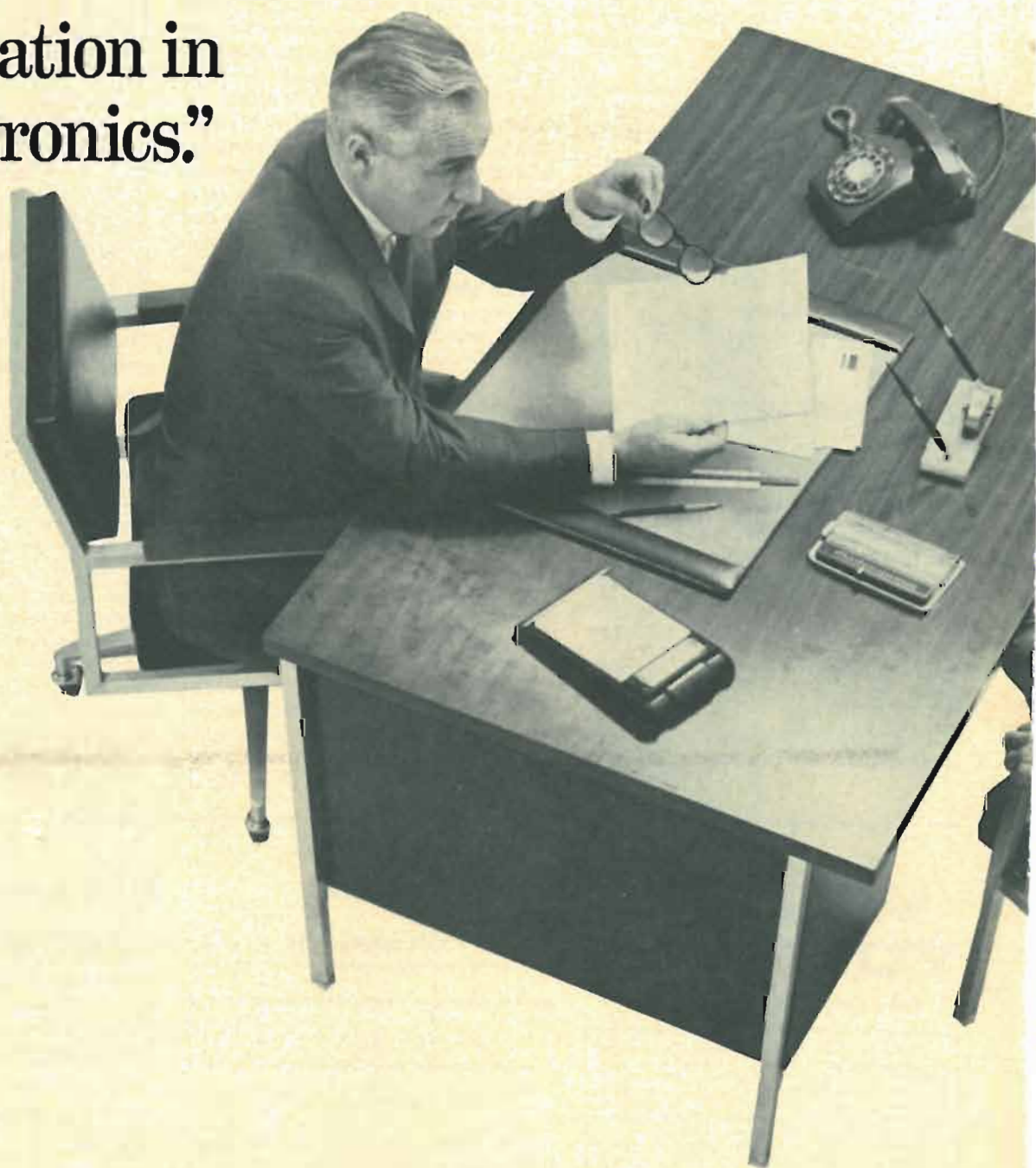



# Could they be talking about you?

You'll miss a lot of opportunities if you try to get along in the electronics industry without an advanced education. Many doors will be closed to you, and no amount of hard work will open them.

But you can build a rewarding career if you supplement your experience with specialized knowledge of one of the key areas of electronics. As a specialist, you will enjoy security, excellent pay, and the kind of future you want for yourself and your family.

Going back to school isn't easy for a man with a full-time job and family obligations. But CREI Home Study Programs make it possible for you to get the additional education you need without attending classes. You study at home, at your own pace, on your own schedule. You study with the assurance that what you learn can be applied to the job immediately.

CREI Programs cover all important areas of electronics including communications, servo-mechanisms, even spacecraft tracking and control. You're sure to find a program that fits your career objectives.

You're eligible for a CREI Program if you work in electronics and have a high school education. Our FREE book gives complete information. Airmail postpaid card for your copy. If card is detached, use coupon below or write: CREI, Dept. 1423 E, 3224 Sixteenth Street, N.W., Washington, D.C. 20010.



## The Capitol Radio Engineering Institute

Dept. 1423-E, 3224 Sixteenth Street, N.W., Washington, D.C. 20010

Please send me FREE book describing CREI Programs. I am employed in electronics and have a high school education.

NAME \_\_\_\_\_ AGE \_\_\_\_\_

ADDRESS \_\_\_\_\_

CITY \_\_\_\_\_ STATE \_\_\_\_\_ ZIP CODE \_\_\_\_\_

EMPLOYED BY \_\_\_\_\_

TYPE OF PRESENT WORK \_\_\_\_\_  GI BILL

- I am interested in  Electronic Engineering Technology  
 Space Electronics  Nuclear Engineering Technology  
 Industrial Electronics for Automation  
 Computer Systems Technology

APPROVED FOR VETERANS ADMINISTRATION TRAINING



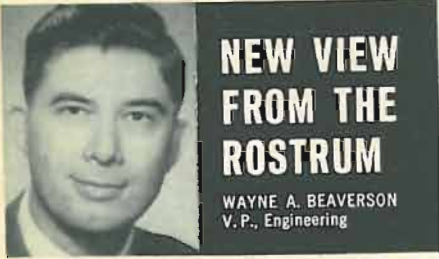

Many fixed rostrum microphone installations are compromises forced by the problems of acoustics, limited available speaker locations, and high mobility of speech makers who do not appreciate the problems created by their movement away from the microphone.

The simplest installations are based on a single omnidirectional microphone mounted on the rostrum. This is an ideal solution if the acoustic conditions are nearly perfect and the performer maintains a uniform distance from the microphone.

Greater working distance and/or higher sound levels can be achieved by substituting a cardioid microphone. By rejecting noise and lowering feedback sensitivity to the rear, the cardioid minimizes effects of the acoustical environment. Unfortunately, it also restricts lateral movement of the performer to about a 90° angle relative to the face of the microphone.

A common solution to the latter problem has been the use of two cardioid microphones, one on each side of the rostrum and angled in toward the center. While this does give a greater degree of freedom to the performer, erratic sound levels result as the performer approaches first one microphone, then the other. Even more serious degradation occurs due to phase difference caused by spatial differences as the subject moves relative to the two microphones.

One solution to these objections, employing two cardioid microphones, has recently been introduced. Basically, the two units are placed close together at the center of the rostrum, and angled out (from 15° to 25°). Optimum separation seems to be about 6 to 20 inches. This relocation reduces both phasing and amplitude differences to a minimum, while offering the performer the widest possible area of effective sound pickup. It is essential that both microphones be electrically in-phase and well matched.

While slightly greater feedback sensitivity may occasionally result from this arrangement, overall results are generally superior. A full discussion of this suggested technique, with diagrams, is included in the February, 1964 issue of *Microphone Facts* (pp. 97-101). It is available free on request from the address listed below.

For technical data on any E-V product, write:  
ELECTRO-VOICE, INC., Dept. 173E  
613 Cecll St., Buchanan, Michigan 49107



Circle 25 on reader's service card

## EQUIPMENT REPORT

### Sencore CG-10 "Lo-Boy" Color Generator

Circle 38 on reader's service card

COLOR-BAR GENERATORS ARE GETTING smaller and handier all the time. One of the newest is the Sencore CG-10 Lo-Boy, which is only 3 inches high, 10 inches wide and 10 inches deep. It's all-transistor and powered by self-contained dry cells, eight of them. With a total drain of only 16 to 20 mA, battery life ought to be pretty good.



All the standard color-TV test patterns are provided in the CG-10: vertical and horizontal lines, dots, cross-hatch, and the 10-bar keyed-rainbow color pattern. Two crystals are used: a 189-kHz for the timers, and a 3.56-MHz for the color-bar pattern. The rf carrier can be tuned to any low-band TV channel from 2 to 6. Fourteen transistors, 6 diodes and a Zener are used in the CG-10.

All controls are on the front panel (see photo), except for dot-size and rf tuning, which aren't needed so often and are on the bottom. A gun killer, separate from the generator circuits, has its control switches on the front, and a plug-in cable assembly is on the back.

The circuit starts with the familiar 189-kHz crystal oscillator, followed by only three "timer" or countdown stages. (Some original versions of this circuit used six or seven!) These timers are actually blocking oscillators. The "timing elements" are the only difference between them. A very high divide ratio is used. The first stage divides by 12, the next by 17 or 18 and the last by 15.

This high countdown ratio is made possible by the inherent characteristics of transistors. Their low rise time and very sharp cutoff characteristics make them ideal for pulse-generator work, and that's what these circuits are.

Dividing 189 kHz by 12 gives us the 15.75-kHz line frequency. This is fed through a shaper circuit, to develop horizontal pulses in the sync shaper, and also feeds a sync signal to the second timer, Q4.

The timer circuit (see diagram) is novel: Q4 divides the 15.75-kHz signal alternately by 17 and 18, controlled by bistable multivibrator Q5-Q6. Q4's output is 450-Hz pulses, for third counter stage Q7. Another set of 450-Hz pulses comes through C15 from a circuit called a half-line multivibrator (Q10-Q11).

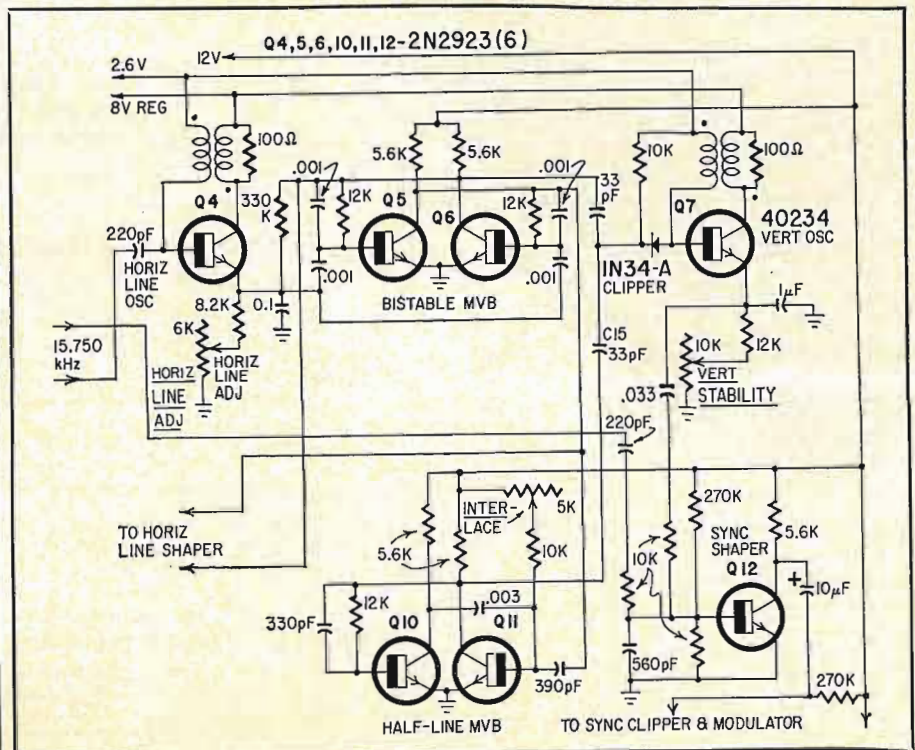



The last ones are delayed so that they appear between the first pulses, and the result is 900-Hz pulses! The third counter stage (Q7) divides the 900-Hz signal by 15 and makes 60-Hz vertical sweep. This signal is also fed to a sync shaper to make vertical-sync pulses.

Each time the horizontal-line oscillator (Q4) divides by 17, the half-line multivibrator fires and generates a new pulse 20-40  $\mu$ sec later. This "later" can be controlled by the INTERLACE control on the front panel. The vertical oscillator locks to this pulse source every other time it fires (it divides by an *odd* number); this allows us to shift one *field* of the TV raster by about 10  $\mu$ sec. Try this on a TV set with a sharply focused raster, and you can see the interlace change; one set of lines moves up and down! This is used to change the horizontal lines, making them wider or narrower, as you like. It also helps to get rid of jitter in the patterns. A similar arrangement is used to help to stabilize the horizontal-line pattern.

A gun-killer assembly is provided, completely separate from the rest of the generator. The control switches are on the right end of the front panel. A polarized socket on the back connects them to a set of color-coded leads. Each lead has a 100K isolating resistor mounted inside the insulation-piercing alligator clip. No adapters are needed. Just hook up to the solid-colored wires on the base of the color CRT—they're the grids. Ground return is made through the low dc resistance of the rf output cable ground lead.

The CG-10 is powered by eight C-cells in two plastic tubes. The tubes are replaceable, so if you forget and leave the batteries in too long, it won't damage the instrument. A battery-test terminal board is mounted on the back panel. This is connected through the on-off switch, so that you automatically measure battery voltage under full load, as you should.

The power supply to the crystal oscillator and timer stages is regulated at 8 volts by a Zener diode. All other stages are fed from the 12-volt line. The generator works well with a supply voltage from 12 to 9.5, below which batteries must be replaced.

As I said, this instrument uses only three timer stages. The controls are on the front panel. Each is plainly marked with "what it does": At the top is the horizontal-hold control, at the bottom the vertical-hold control, and in the center, the intermediate timer, which controls the number of horizontal lines you see in the pattern. As it says, "Adjust for 13 bars."

The hold controls act just like their receiver equivalents. If you get a slant-

# WHY risk your reputation with "just-as-good" capacitors?

When you pay little or no attention to quality in tubular replacement capacitors, you leave yourself wide open for criticism of your work . . . you risk your reputation . . . you stand to lose customers. It just doesn't pay to take a chance on capacitors with unknown or debatable performance records when it's so easy to get guaranteed *dependable* tubulars from your Sprague distributor!

## There's no "maybe" with these 2 great SPRAGUE DIFILM® TUBULARS!

The ultimate in tubular capacitor construction. Dual dielectric . . . polyester film and special capacitor tissue . . . combines the best features of both. Impregnated with HCX®, an exclusive Sprague synthetic hydrocarbon material which fills every void in the paper, every pinhole in the plastic film *before it solidifies*, resulting in a rock-hard capacitor section . . . there's no oil to leak, no wax to drip. Designed for 105°C (220°F) operation *without voltage derating*.

### DIFILM® ORANGE DROP® Dipped Tubular Capacitors



A "must" for applications where only radial-lead capacitors will fit . . . the perfect replacement for dipped capacitors now used in many leading TV sets. Double-dipped in rugged epoxy resin for positive protection against extreme heat and humidity. No other dipped tubular capacitor can match Sprague Orange Drops!



### DIFILM® BLACK BEAUTY® Molded Tubular Capacitors

The world's most humidity-resistant molded capacitors. Tough, protective outer case of non-flammable molded phenolic . . . cannot be damaged in handling or installation. Black Beauty Capacitors will withstand the hottest temperatures to be found in any TV or radio set, even in the most humid climates.

For complete listings, get your copy of Catalog C-616 from your Sprague distributor, or write to Sprague Products Company, 81 Marshall Street, North Adams, Massachusetts.

WORLD'S LARGEST MANUFACTURER OF CAPACITORS





## Thinking of college and a space age career in electronics?

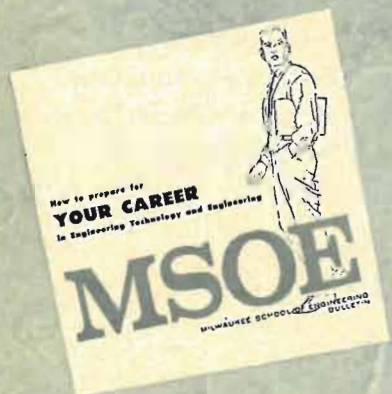

### Send for this booklet on ENGINEERING TECHNOLOGY AND ENGINEERING

Learn how you can prepare for a dynamic career as an electrical or mechanical engineering technician or engineer in such exciting, growing fields as avionics, missiles, reliability control, fluid mechanics, data processing, metallurgy, microelectronics, and advanced aerospace research.

MSOE offers residence study programs leading to these degrees in engineering technology and engineering

2 years—Associate in Applied Science  
4 years—Bachelor of Science

Also get facts about scholarships and financial aids, job placement and other student services, plus photographs of MSOE technical laboratories and student activities. For your copy, just mail the coupon—no obligation.

# MSOE

Milwaukee School of Engineering  
Dept. RE-167, 1025 N. Milwaukee St.,  
Milwaukee, Wisconsin 53201

Please send the "Your Career" booklet.  
I'm interested in

Electrical fields  Mechanical fields

Name.....Age.....

Address.....

City.....State.....ZIP.....  
MS-227A

Circle 24 on reader's service card

ing-line pattern, out of horizontal sync, simply adjust the upper or horizontal-hold control, and the pattern will lock in. Hold-control adjustment is easy; you set each to a knob index, perhaps twiddle it slightly, and the pattern falls into sync right away.

I recommend using a strong station signal to set H and V hold controls on a receiver, and then setting the generator's sweep controls to match. This method uses the program as reference, which is what the customer watches! Also, you avoid misconvergence if your generator happens to be slightly off.

For a complete convergence job, most manufacturers recommend starting with vertical lines only, getting them all lined up, then going to horizontal lines only, then finally to the crosshatch for final touchup.

The gun killer is, of course, very useful. You kill the blue gun, for example, and go through the R and G adjustments. You should wind up with a nice yellow raster.

The CG-10, by the way, doesn't come on instantly. Although solid-state, it contains a large (100- $\mu$ F) electrolytic across the 8-volt regulated line, which must charge. This takes 8 or 10 seconds. At this point, the generator's output appears. I made my pet stability test—tuned the CG-10 to color bars (as seen on a receiver), then turned it off for a few minutes, then turned it back on. The bars came in right on the button! This is an exacting test; any tuning drift shows up instantly as a change in colors of the bars.

The instruction book is helpful and informative. A full, legible schematic shows all operating voltages and currents. A trouble chart tells you how to keep the instrument working properly. On the back cover is a layout chart of the PC board used in the CG-10. It even tells which color wire goes to what terminal!

Things that impressed me: All controls and cables are plainly marked, so you can't get confused. Battery replacement information is marked on the CG-10's case. All in all, this generator is useful and compact at a reasonable price. Nice.—*Jack Darr*

Price: \$89.95, wired only

### Want to Identify Strange Transistors?

There is a device you can do it with, and know exactly what any particular transistor will do in a circuit, what voltages will make it operate best, etc. You'll learn how to build it in

**FEBRUARY  
RADIO-ELECTRONICS**

## Heathkit GR-25 Color Receiver

Circle 39 on reader's service card

FOR SEVERAL MONTHS NOW, I'VE PROBABLY answered more questions on Heath's GR-25 color TV receiver than on any other piece of current electronic equipment. Friends who've seen my GR-25 generally ask, "Why can't I get a good picture like that on my color set?" or "Why did you build a set when your experience should enable you to purchase a good set for less?"

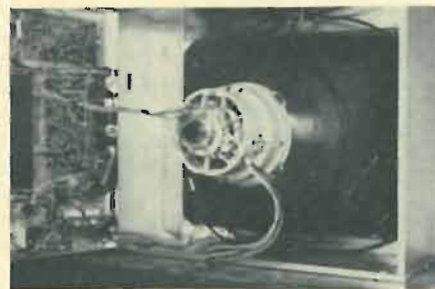

In reply to the first question, I point out that the brighter picture with more vibrant colors is produced by a picture tube that uses new rare-earth phosphors that were not used until just a year or so ago. I then add that the picture on a color set is adversely affected by stray magnetic fields. In the GR-25, the picture tube is almost completely shielded from external magnetic fields. In many other sets, the CRT's are not shielded and are easily magnetized by nearby lightning strokes, by the turning off of a nearby fan or vacuum cleaner, or even by the earth's magnetic field when the set is moved around while cleaning or decorating. Too, the picture tube, like in many sets made during the last 2 years, is automatically demagnetized (de-gaussed) each time you turn the set on. This insures good color purity and registration—even after the set has been moved around.

Also, the receiver uses the very latest in circuit developments to greatly simplify convergence—making it possible for the set builder to do a better convergence job in less time than many experienced technicians can do on an older model.

In answering the second question, I point out the pleasures of building (and troubleshooting) a piece of complex equipment, of being able to make color adjustments to meet my personal taste rather than accept the standards of a technician who sets up a factory-built set. The design of the chassis makes all test points and components readily available to the builder who wants to do his own maintenance. The built-in dot



# RCA ANNOUNCES NEW ANTENNA ACCESSORIES ENGINEERED FOR COLOR TV

New catalog tells the full-line story.  
Get it from your RCA Distributor.

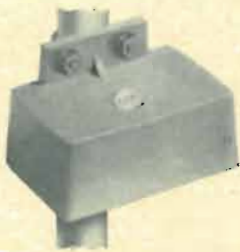

# 5

## RCA Deluxe Transistorized Antenna Amplifiers

... a full line of dual purpose units with the most advanced silicon transistors in high-gain, low-noise circuits. They are masterfully designed to bring in the sharpest picture on color or black and white TV. Or they can drive multiple receivers from a single antenna using RCA multi-set couplers as a small distribution system. Five types include: 300 ohm UHF type 10P223; 300 ohm VHF/FM type 10P213; 75 ohm coaxial VHF/UHF type 10P215 and 10P235; and 300 ohm VHF/UHF type 10P233—all with remote, A.C. operated power supplies.



# 4

## RCA Deluxe Multi-Set Couplers

... UHF/VHF/FM 300 ohms, couple two or four sets to one antenna or amplifier. Channels 2 to 83, types 10P302 and 10P304. Also VHF/FM 75 ohm coaxial types 10P752 2-set coupler; 10P754 4-set coupler.



# 3

## RCA Deluxe Band Splitters

... Separate UHF, VHF and FM signals from a single transmission line or combine separate antennas. 300 ohms. Three types include: 10P311 couples VHF/UHF signals to one line; 10A135 separates UHF and VHF at set; 10P312 separates UHF, VHF and FM.

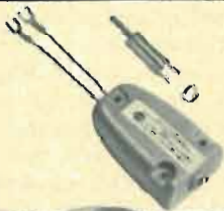

# 3

## RCA Deluxe Coaxial-to-twin lead Transformers

... streamlined for fast installation. Coax plugs in using solderless connector. Terminals for twin lead connections. Models: 10P723 and 10P753 for indoor use and 10P375 for outdoor use.



# 2

## RCA Deluxe Lightning Arrestors

... Positive contact with all varieties of twin-lead (flat, round, and oval). Eliminate lead stripping, insert line in slot, screw on cap for fast installation. Low insertion loss, does not increase VSWR of a good antenna even at critical UHF frequencies. Screw mount type 10A118; and strap-mount type 10A119.

When you buy antenna accessories bearing the  
RCA Mark of Quality, you know they're reliable.

RCA PARTS AND ACCESSORIES, DEPTFORD, N.J.



The Most Trusted Name in Electronics



# NOW

FROM



## A Complete Automotive and Ignition Tune-Up System



### MARK TEN

Capacitive Discharge Ignition System

\$44<sup>95</sup> Assembled

\$29<sup>95</sup> Kit Form

Get mileage you never dreamed of! 3 to 10 times spark plug life. Instant starts in all weather. Installs in only 10 minutes. Up to 20% gas savings. Dramatic increase in engine performance and acceleration.

## 2 NEW AUTO TUNE UP INSTRUMENTS



**DWELL METER**  
\$12.95 Ppd.



**TACH METER**  
\$14.95 Ppd.

These two new cousins to the world famous proven MARK TEN now give you the capability to tune your own car inexpensively, easily, with remarkable precision. These separate instruments are low cost, portable and the easiest to read you've ever seen.

- Delta's famous printed circuit design
- Superior in precision, quality and performance to instruments selling for FIVE TIMES as much
- Large dial, high quality jewel D'Arsonval meters
- Operates with standard, transistor or capacitive discharge systems as well as magnetos
- Instant readings — no confusing scales

Send Your Order Today



## DELTA PRODUCTS, INC.

P.O. Box 1147 RE • Grand Junction, Colo.

Enclosed is \$\_\_\_\_\_ Ship prepaid.

Ship C.O.D.

Please send:

- Dwell Meters @ \$12.95
- Tach Meters @ \$14.95
- Mark Tens (Assembled) @ \$44.95
- Mark Tens (Delta Kit) @ \$29.95

(12 volt positive or negative ground only)

SPECIFY —  Positive  Negative

6 or  12 Volt

Car Year \_\_\_\_\_ Make \_\_\_\_\_

Name \_\_\_\_\_

Address \_\_\_\_\_

City/State \_\_\_\_\_ Zip \_\_\_\_\_

DP 6-11

generator (see diagram) eliminates the necessity of using a color generator—in most cases one of the most essential color test instruments.

If you are looking for a color set for a custom installation, the GR-25 is one of the few available without a cabinet but with a finished escutcheon (front panel). You can build it into a wall, a custom cabinet or install it in the oiled-walnut cabinet available from Heath. In the latter, the 12 convergence adjustments and the height, vertical linearity, agc, sync, color-killer and dots controls are on the convergence bracket. The bracket can be mounted in a spot convenient to the operator or the service technician. In the Heath cabinet, the convergence bracket is mounted on the tilt-out speaker panel.

The set has 27 tubes, 10 diodes and 1 transistor (in the uhf tuner). The picture tube is completely shielded—except for the face—by a steel case or cabinet which Heath calls the Magna-Shield. The rear of this case is hinged and is used as the chassis.

In replying to interested readers, I give them a rundown on the set's circuitry and features of interest to the knowledgeable do-it-yourself'er, student and technician, pointing out that building and adjusting a color set is an excellent way to put theory into practice.

Building the set is not difficult. The 180-page manual is well laid out and very easy to follow. The tuner and i.f.-amplifier circuit board are prewired and aligned. The horizontal-output and high-voltage sections are prewired. All you have to do is mount the parts on the printed-circuit sound-sync, color and convergence boards; mount the remaining parts on the chassis and connect them with multiconductor color-coded wiring harnesses.

Heath says that the set can be completed in about 25 hours. Taking my time, I completed the wiring, prelimi-

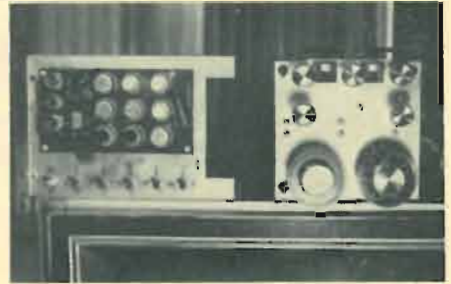

nary adjustments and dc convergence in about 30 hours and had a beautiful black-and-white picture.

Sync was a little critical and there was a hum that varied with the setting of the vertical hold control. Voltage and resistance measurements were within tolerances when measured at the tube socket terminals on the underside of the printed boards. I suspected a cold solder joint and concentrated on checking the connections I had made. Finally, I used socket adapters and repeated the voltage measurements. The screen grid of the sound i.f. and sync amplifier read 20 volts at the adapter socket and 145 on the underside of the board. A magnifying glass revealed a hair-line crack in the foil at the screen-grid terminal. A dab of solder solved this problem and gave me stable sync and beautiful hum-free sound.

The next step was dynamic convergence. This was quick and easy—much simpler and faster than I'd imagined it would be. Now, only one thing was wrong: no color on color broadcasts. Well, back to the soldering iron and magnifying glass. By repeatedly touching up all soldered joints—even those remotely connected to the color-killer, color-oscillator and related circuits—I finally got good color reception.

A few construction hints: When you've completed the wiring and are ready for preliminary adjustments, you'll find the manual instructs you to hang the convergence bracket and tuner on the right side of the shield box. There is a 12-wire cable that runs from the convergence bracket to the pole-piece assemblies on the rear of the yoke. When you swing the vertical chassis into place, make sure that this cable does not snag on tubes or other components on the i.f. circuit board. You could break a tube or do even more serious damage. Too, watch out for the lead from the chassis to the degaussing coil. You'll snip it in half if it gets caught between the bottom of the chassis and the shield.

Inspect the pole-piece assemblies carefully before you mount them in their holders. On two, I found that the leads from the coils had not been soldered to the lugs.—Robert F. Scott END

Price: \$469.95, kit only

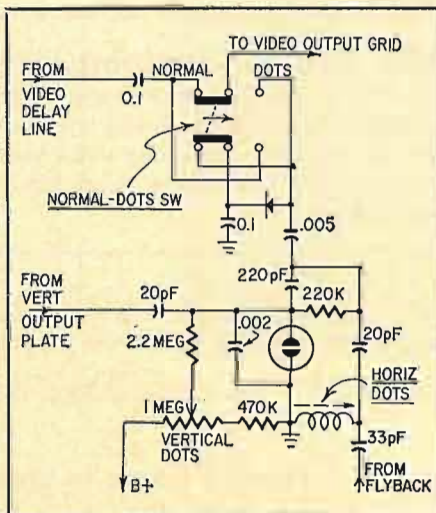



# Compare Color Generators

look at the rest... and you'll buy the best, new B&K model 1245

The all solid-state B&K Model 1245 Color Generator duplicates the waveforms transmitted by a color TV station.

Adherence to these waveforms makes it easy to converge the color tube, check sync and make other raster adjustments . . . and the color generator with station quality signal will be able to sync next year's sets. Generators with compromise waveforms do not give you this obsolescence protection.

Here are oscilloscope photographs from the outputs of two typical competitive color generators, one transistorized and one tube type, and the B&K Model 1245. The detailed analysis with each photograph shows a few of the reasons why you'll save time and effort with B&K.

## COLOR

## CROSSHATCH

### STANDARD STATION SIGNAL



One horizontal sync pulse with its color burst.



Two lines showing horizontal sync pulse with black and white tv signal



Good duplication of station signal including back porch. If the set won't sync, the set is defective.



Well defined back porch on horizontal sync pulse permits accurately setting color killer and almost eliminates need to adjust brightness and contrast.

### TRANSISTORIZED GENERATOR A



No back porch causes unstable color sync. Burst amplitude compression may permit sync on wrong color bar.

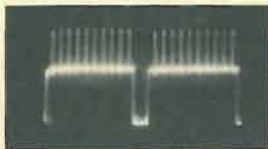

Square wave horizontal sync pulse with no back porch and poor dc coupling forces adjustments of brightness, contrast & fine tuning to obtain usable pattern.

### GENERATOR B

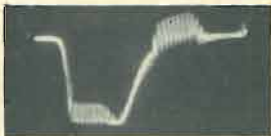

No back porch; color information on top of sync-pulse makes sync difficult on some sets.

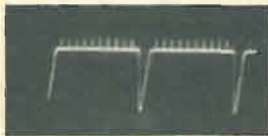

Complete absence of any back porch necessitates readjustment of brightness, contrast and fine tuning to obtain a usable pattern.

See your B&K Distributor for a demonstration or write for Catalog AP22.

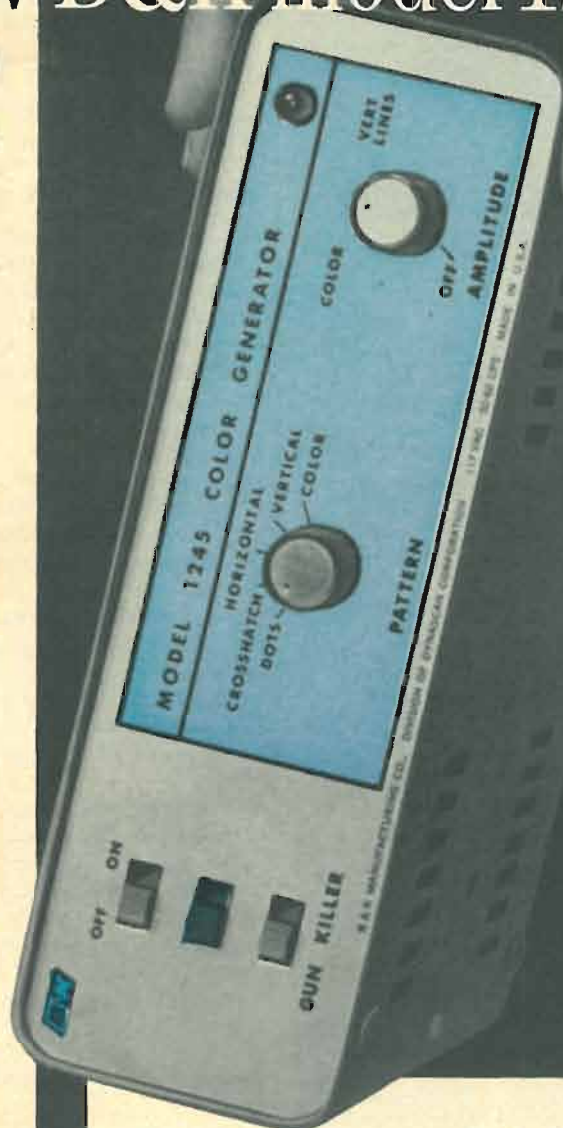

For the first time, with the no-compromise waveforms from the B&K Model 1245, it is possible to accurately set the color killer threshold control with a color generator.

The miniature size and convenience of the Model 1245 match its performance. It provides crystal-controlled keyed rainbow color bar display, and dot, crosshatch, horizontal line and vertical line patterns as well as gun killer controls that will work with any picture tube. Size only 2 7/8 x 8 1/2 x 8 7/8". Net \$134<sup>95</sup>.







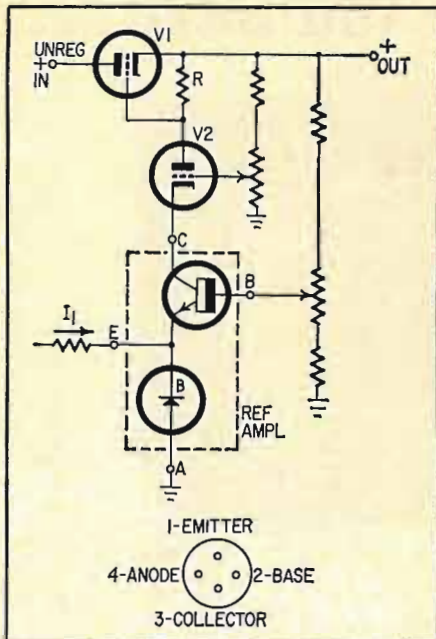

son Electronics units consist of an npn silicon transistor and a silicon voltage regulator diode having equal but opposite temperature coefficients. In addition, these elements are assembled to minimize the temperature differential and thus permit operation over a wide range of temperatures.

Maximum ratings: collector-to-emitter voltage 30, collector current 10 mA, total VR diode current 10 mA, power dissipation (25°C in free air) 300 mW. The numeral suffix indicates the temperature coefficient in parts-per-million. Complete electrical characteristics and application notes are contained in a comprehensive data sheet. The diagram, taken from the data sheet, shows how the reference amplifier may be used in a typical tube-type voltage regulator. The value of R is set so 100  $\mu$ A flows through it with a nominal value of output current. If the output voltage tends to increase, the reference-amplifier collector current increases. This increases the plate current of V2. The increased voltage drop across R increases the plate current of V2, thus lowering the voltage to its desired value.

#### ALL-GLASS RECTIFIERS

The 1N4383 through 1N4386 form a series of new Sylvania all-glass rectifiers. These silicon double-diffused units are capable of delivering 1 amp at 100°C at reverse working voltages to 1 kV. The glass package, 0.35 in. long and 0.12 in. in diameter, provides a hermetic seal with a leak rate less than  $1 \times 10^{-10}$  cc/sec. These 48-cent units can be used as half- or full-wave rectifiers, voltage multipliers and in blocking, damper and surge-suppressor applications. END

**NOW!**

**Join the  
P.O.M. Club!**

(Photofact-of-the-Month Club)

**ONLY \$10 PER MONTH  
brings you 20% MORE  
PHOTOFACT® coverage!**

**NOW! more current model  
coverage each month to keep  
you ahead earning more—  
AND YOU SAVE OVER  
\$60 PER YEAR!**

As a PHOTOFACT-OF-THE-MONTH CLUB member, you get 6 new PHOTOFACT Sets every month—the world's finest TV-radio service data—with all the time-saving, profit-boosting help you want!

**AT LEAST  
6 COLOR TV  
FOLDERS MONTHLY**

**complete current coverage of  
at least 50 chassis each and  
every month for less than  
20¢ per chassis model!**

To stay ahead, to save money (individually purchased sets now sell for \$2.50 each)—join the PHOTOFACT-OF-THE-MONTH CLUB now!



**20%  
more!**

**this great new monthly package  
exclusively for P.O.M. members!**

You get your 6 new PHOTOFACT Sets every month in sturdy new file folders sealed in factory carton to insure perfect condition and completeness—easier-than-ever to file and use. Now—only \$10 per month and you get 20% MORE COVERAGE!

#### TRY A THREE-MONTH P.O.M. SUBSCRIPTION

see how  
**PHOTOFACT**  
boosts your  
earning power!

subscribe through  
your Sams  
Distributor  
or use this  
handy  
order form

**HOWARD W. SAMS & CO., INC. Dept. REF-1**  
4300 W. 62nd St., Indianapolis, Ind. 46268

Enroll me for a 3-month membership in the Photofact-of-the-Month Club. I agree to pay \$10 per month, and understand I will receive 6 current Photofact Sets monthly for 3 months to be delivered by my Sams Distributor (named below).

Name \_\_\_\_\_

Shop Name \_\_\_\_\_

Address \_\_\_\_\_

City \_\_\_\_\_ State \_\_\_\_\_ Zip \_\_\_\_\_

My Sams Distributor is: \_\_\_\_\_

Signed: \_\_\_\_\_



# How To Have Fun While You Save . . .

**Regardless  
Of What You Pay  
For A Color TV...  
It Can't Perform As  
Well As This  
New Heathkit® "180"  
For Only \$379<sup>95</sup>\***



## Here's Why!

### Exclusive Features That Can't Be Bought In Ready-Made Sets At Any Price!

All color TV sets require periodic convergence and color purity adjustments. This new Heathkit GR-180 has exclusive built-in servicing aids so you can perform these adjustments anytime . . . without any special skills or knowledge. Just flip a switch on the built-in dot generator and a dot pattern appears on the screen: Simple-to-follow instructions and detailed color photos in the GR-180 manual show you exactly what to look for, what to do and how to do it.

Results? Beautifully clean and sharp color pictures day in and day out . . . and up to \$200 savings in service calls throughout the life of your set.



### Exclusive Heath Magna-Shield!

This unique metal shield surrounds the entire picture tube to help keep out stray external fields and improve color purity. In addition, *Automatic Degaussing* demagnetizes and "cleans" the picture everytime you turn the set on from a "cold" start . . . also permits you to move the set about freely.



### Vertical Swing-Out Chassis!

All parts mount on a single one-piece chassis that's hinged

to make it more accessible for easier construction, care and installation.

### Your Choice Of Installation!

Another Heathkit exclusive . . . the GR-180 is designed for mounting in a wall or your own custom cabinet. Or you can install it in either of Heath's factory-assembled and finished cabinets.



### From Parts To Programs In Just 25 Hours!

. . . and no special skills or knowledge needed. All critical circuits (VHF and UHF tuners, 3-stage IF assembly and high voltage power supply) are prebuilt, aligned and tested at the factory. The GR-180 manual guides you the rest of the way with simple, non-technical instructions and giant pictorials. It's like having a master teacher at your elbow pointing out every step. You can't miss.

### Compare These Advanced Performance Features . . . And The Price!

**Hi-Fi 180 Sq. Inch Rectangular Tube** with anti-glare safety glass, plus "rare earth phosphors", smaller dot size and 24,000 volt picture power for brighter, livelier colors and sharper picture definition.

**Automatic Color Control** and gated automatic gain control to reduce color fading, and insure steady, jitter-free pictures even under adverse interference such as nearby aircraft traffic.

**Deluxe VHF Turret Tuner** with "memory" fine tuning so you don't have to readjust everytime you return to a channel.

**2-Speed Transistor UHF Tuner** for either fast station selection, or fine tuning of individual channels.

**Two Hi-Fi Sound Outputs** . . . a cathode follower for play through your hi-fi system, plus an 8 ohm output for connection to the GR-180's limited-field 4" x 6" speaker.

**Two VHF Antenna Inputs** . . . a 300 ohm balanced and a 75 ohm coax to reduce interference in metropolitan or CATV areas.

**1-Year Warranty** on the picture tube, 90 days on all other parts. In addition, liberal credit terms are available.

**\*Kit GR-180**, everything except cabinet for custom mounting, 102 lbs. . . . . **\$379.95**

**Assembled GRA-180-1**, walnut cabinet shown above, 30 lbs., 18 1/4" D x 28 1/4" W x 29" H. . . . **\$49.95**

**Assembled GRA-180-2**, Early American cabinet, 37 lbs., 18 1/4" D x 28 1/4" W x 31 3/4" H. . . . Available February . . . . . **\$75.00**

## New 12" Transistor Portable TV — First Kit With Integrated Circuit

Unusually sensitive performance. Plays anywhere . . . runs on household 117 v. AC, any 12 v. battery, or optional rechargeable battery pack (\$39.95). Receives all channels; new integrated sound circuit replaces 39 TV parts; 3-stage IF for maximum gain with controlled bandwidth; gated AGC for steady, jitter-free pictures; instant "on" AC operation; preassembled & aligned tuners for peak performance; transformer operated power supply; front panel mounted speaker; easy 12-hour assembly. Rugged high impact plastic cabinet measures a compact 11 1/2" H x 15 1/4" W x 9 3/8" D. 27 lbs.

Kit GR-104  
**\$119<sup>95</sup>**



Circle 34 on reader's service card



# Build Your Own Heathkit® Electronics



**Heathkit "Starmaker"  
60-Watt Transistor  
Guitar Amplifier**

Kit TA-16  
**\$129<sup>95</sup>**  
\$300 Value!

60 watts peak power; two channels — one for accompaniment, organ or mike, the other with tremolo and reverb for lead guitars; two inputs per channel; two 12" heavy-duty speakers; line bypass reversing switch for hum reduction; 13 transistor, 6 diode circuit; 28" W x 9" D x 19" H. Leather-textured black vinyl cabinet of 3/4" stock; 120 v. or 240 v. AC operation; extruded aluminum front panel. 52 lbs.

**Harmony-By-Heathkit®  
Electric Guitar**



Kit TG-46  
**\$219<sup>95</sup>**  
\$331.50 Value!

Double cutaway style; hollow body; 3 pickups with 18 adjustable pole pieces; professional Bigsby vibrato tailpiece; 6 volume & tone controls; ultra-slim fingerboard — 24 1/4" scale; 2" thick curly maple body, shaded cherry red. Includes carrying case, neck strap, visual tuning aid, cord, pick, instruction book and record. 2 other models available at \$99.95 and \$119.95. 17 lbs.

**New! SB-101 80-10 Meter SSB Transceiver  
— Now With Improved CW Transceive Capability**



Kit SB-101  
**\$360<sup>00</sup>**  
(less speaker)

Now features capability for front panel switch selection of either the standard 2.1 kHz SSB filter or the optional SBA-301-2 400 Hz CW filter . . . plus simplified assembly at no increase in price over the already famous Heathkit SB-100. Also boasts 180-watt P.E.P. input, 170 watts input CW, PTT & VOX, CW sidetone, Heath LMO for truly linear tuning and 1 kHz dial calibrations. 23 lbs. SBA-301-2, 400 Hz CW filter . . . \$20.95. Kit HP-13, mobile power supply . . . \$59.95. Kit HP-23, fixed station supply . . . \$39.95.

**NEW Transistor Portable  
Phonograph Kit**



Kit GD-16  
**\$39<sup>95</sup>**

Worth At Least 50% More! And it sounds better. Assembles in just 1 to 2 hours . . . simply wire one small circuit board, mount the 4" x 6" speaker and plug in the preassembled changer . . . ideal beginner's kit. Features automatic mono play of all 4 speeds; dual Sapphire styli for LP's or 78's; 45 rpm adapter; olive and beige polyethylene over sturdy, preassembled cabinet. Operates on 117 v. AC. 23 lbs.

**NEW Heathkit® /Magnecord® 1020 4-Track Stereo  
Recorder Kit**



Kit AD-16  
**\$399<sup>50</sup>**  
(less cabinet)

Save \$170 By Doing The Easy Assembly Yourself. Takes around 25 hours. Features solid-state circuitry; 4-track stereo or mono playback and record at 7 1/2" & 3 3/4" ips; sound-on-sound, sound-with-sound and echo capabilities; 3 separate motors; solenoid operation; die-cast top-plate, flywheel and capstan shaft housing; all push-button controls; automatic shut-off at end of reel; plus a host of other professional features. 45 lbs. Optional walnut base \$19.95, adapter ring for custom or cabinet installation \$4.75

**30-Watt Solid-State FM /FM Stereo Receiver**



World's Best Buy In Stereo Receivers. Features 31 transistors, 10 diodes for cool, natural transistor sound; 20 watts RMS, 30 watts IHF music power @ ± 1 db, 15 to 50,000 Hz; wideband FM/FM stereo tuner; plus two pre-amplifiers; front panel stereo headphone jack; compact 3 7/8" H x 15 1/4" W x 12" D size. Custom mount it in a wall, or either Heath cabinets (walnut \$9.95, beige metal \$3.95). 16 lbs.

Kit AR-14  
**\$99<sup>95</sup>**  
(less cabinet)



**FREE!**  
**World's Largest  
Electronic Kit  
Catalog!**

Describes these and over 250 kits for stereo/hi-fi, color TV, amateur radio, shortwave, test, CB, marine, educational, home and hobby. Save up to 50% by doing the easy assembly yourself. Mail coupon or write Heath Company, Benton Harbor, Michigan 49022

**HEATH COMPANY, Dept. 20-1**  
Benton Harbor, Michigan 49022  
In Canada, Daystrom Ltd.

Enclosed is \$ \_\_\_\_\_, plus shipping.

Please send model (s) \_\_\_\_\_

Please send FREE 1967 Heathkit Catalog.

Name \_\_\_\_\_

Address \_\_\_\_\_

City \_\_\_\_\_

State \_\_\_\_\_

Zip \_\_\_\_\_

Prices & specifications subject to change without notice.

CL-267





**FINCO**  
"has 'em both!"



Model #65-1  
\$29.95  
list

Model #65-2  
\$39.95  
list

**BOOSTER COUPLERS  
FOR 300 OR 75 OHM**  
For Deluxe Home or Commercial Use

Now available for either 75 OHM CO-AX or 300 OHM operation . . . you can't beat the price, quality and performance of Finco's famous 2-tube, 4-set VHF or FM Distribution Amplifiers. Finco challenges 'em all! Equip either model with Finco low loss splitters (#3001 or #3003) and you can drive up to 16 sets in a master antenna system!

All Finco Products Are Engineered for Color!



**THE FINNEY COMPANY**

34 West Interstate Street, Bedford, Ohio

Circle 27 on reader's service card

Because you've got to SEE it to BELIEVE it  
..... we will send you a FREE sample!

*instant lettering*®



**DATAMARK**

— the easy new way to label your projects!

Just rub over the pre-printed words or symbols with a ballpoint pen and they transfer to any surface — looks like finest printing! Label control panels, meter dials, letter on anything!

LOOK FOR *instant lettering*®

**DATAMARK SETS** only \$1.25 each — at leading electronic distributors

DATAMARK SETS AVAILABLE FOR:

- Amateur Radio, CB
- Audio, Hi-Fi, TV
- Experimenter Home Intercom
- Industrial Test Equipment
- Switch & Dial Markings
- Alphabets & Numerals in 1/8", 1/4" and 1/2"

— each set has black, white, and gold  
SEND FOR FREE SAMPLE RE-4

**THE DATA CORPORATION**  
85 HIGHLAND AVENUE • PASSAIC, N. J. 07055

Circle 28 on reader's service card

FROM THE TECHNICIAN'S NOTEBOOK:

**Don't Neglect Color-TV Linearity**

A fine point in receiver servicing that's often overlooked, adjusting the raster to correct proportions will establish you as a "pro"

By **MATTHEW MANDL\***

WHEN YOU GET INVOLVED IN CONVERGENCE, purity and degaussing, don't forget to give the vertical and horizontal linearity a going-over. Too often the color adjustments take so much time we're apt to neglect this final step. True, the linearity touchup won't improve the color reception, but it will add that final professional touch and the customer will enjoy the picture more, even though he may not always know why.

In making home calls for black-and-white servicing, a technician doesn't always carry a crosshatch generator. But the experienced man can do a fairly good job with a few simple tricks.

For the horizontal, adjust the width very slightly beyond the sides, so transmission variations will not show lack of width on some stations. Horizontal drive (if the set has a control for it) is then adjusted to give an average scene good linearity.

\* Industrial electronic consultant and faculty member of Technical Institute, Temple University.

For the vertical, more accurate results are possible. Deliberately misadjust the vertical hold control to get a slow vertical roll. Watch the dark blanking bar as it rolls. Adjust the vertical linearity and height until the bar stays the same thickness throughout the roll.

The same procedures work for color receivers. With color test equipment on hand, however, we have a ready way to check linearity accurately by using the vertical and horizontal pattern-generating features of the equipment. We can do a much better job than we could otherwise.

Technicians use color bar generators to check a color set by injecting the signal into one of the video stages. This produces a rainbow color bar pattern on the screen and helps pinpoint poor color rendition, lack of color, and unbalance between colors. The color display contains colors ranging from yellow through orange, red, blue and green.

Even though vertical and horizontal crosshatch bars are available from these instruments, the horizontal linearity can be checked with the rainbow pattern. Fig. 1 is a black-and-white reproduction of the rainbow pattern on a color receiver that has poor horizontal linearity. Note the wider spacing of the center bars. Here a simple width-control adjustment did the trick, since a misadjustment of this control alters horizontal linearity.

For checking vertical linearity, set the generator to produce horizontal lines as shown in Fig. 2. Note the wider spacing at the top of the screen. Here both the vertical linearity control and the height control have to be adjusted several times to correct the linearity and mask the picture properly in a vertical direction.

While there is interaction between height and linearity controls, requiring juggling with both for final results, there is no interaction between vertical and horizontal linearity. We don't have to go back and recheck horizontal linearity after doing the vertical. And, of course, once you've set vertical and horizontal linearity, they hold for color or black-and-white. Because the job is so simple, there's no reason to neglect it during color servicing—particularly since your color test equipment helps speed the work. END

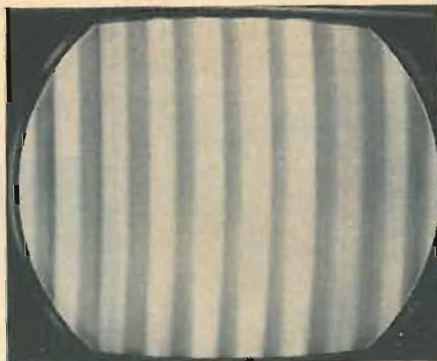

Fig. 1—Black-and-white reproduction of color-bar pattern. Nonuniform width of bars indicates poor horizontal linearity. Adjust horizontal drive for even spacing.

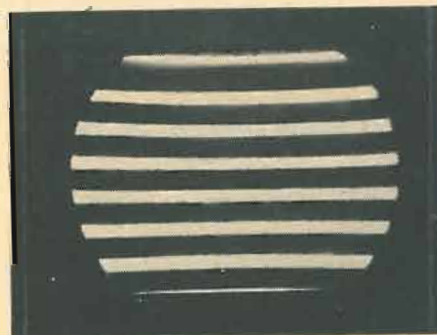



Fig. 2—Horizontal lines, unevenly spaced, point up a case of bad vertical linearity.





With the time it saves\* in set-up, you can take a breather, make a few more calls and still have time to play with the kids.

### \*RCA's new Hi-Lite Color Tube with Perma-Chrome

If you've been waiting half an hour for the picture tube to warm up every time you repair or install a set, here's good news. RCA's new rectangular Hi-Lite Color Tubes with Perma-Chrome lock colors in place instantly, eliminate distorted color as the set warms up. Colors are true and unchanging

from turn-on to turn-off. Saves hours of set-up time. New Hi-Lite Color Tubes with Perma-Chrome now in RCA Victor consoles. **New service switch in all 1967 color chassis.** Three-position for Normal, Service and Raster. When Raster is selected, all video and noise is removed from

the color picture tube, leaving a noise-free Raster. Purity is adjustable without removing an IF tube or using other means to remove noise and/or interference from the screen.



The Most Trusted Name in Electronics

© RCA 1967





# What you don't know about TV, Transistors & Test Instruments, may be costing you a promotion or a pay raise!

Here is an extraordinary offer to introduce you to Gernsback Library's famous Electronics Book Club, specially designed to help you increase your know-how and earning power.

## WHY SHOULD YOU JOIN!

Whatever your interest in electronics—radio and TV servicing, audio and hi-fi, industrial electronics, communications, electronics as a hobby—you'll find that the Electronics Book Club will help you get the job you want, keep it, improve it, or make your leisure hours more enjoyable. By broadening your knowledge and skills, you'll build your income and electronics enjoyment as well.

## WHAT BOOKS ARE OFFERED?

From Gernsback Library and other leading publishers come the country's most respected books in the field of electronics. All are deluxe, hard-covered books of permanent value, offered at considerable cash savings to members, regardless of higher retail prices.

## HOW THE CLUB WORKS

The Electronics Book Club will send you, every other month, the News Bulletin describing a new book on a vital area of electronics. As a member, *you alone* decide whether you want a particular book or not. You get 3 books now for \$1.99 and need take only 4 more within a year, from a wide selection to be offered. And the Club *saves you money* on the books you take, regardless of higher retail prices.

## HOW TO JOIN

Simply mail the coupon today. You will be sent your three handbooks—BASIC TV COURSE, FUNDAMENTALS OF SEMICONDUCTORS and THE OSCILLOSCOPE (regular retail price \$15.55). We will bill you \$1.99 (plus a few cents postage). If you are not pleased with the books, send them back within 10 days and membership will be cancelled. Otherwise you will enjoy these benefits:

- ★ Get three books immediately for \$1.99 (regular \$15.55 value).
- ★ Free 10-day examination privilege.
- ★ Continuous cash savings.
- ★ Free charts and reports given with many books.
- ★ You alone decide which books you want. Books are returnable.
- ★ Club Books are practical working tools, written by experts.

Get these three income-boosting books ... a \$15.55 value

only **\$1.99**

by joining the Electronics Book Club today!

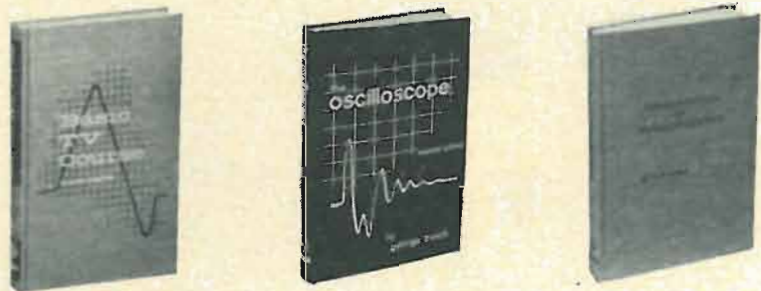

### BASIC TV COURSE

By George Kravitz. Perfect introduction to TV, in clear, non-mathematical language. Starting with the forming of the picture, the book shows how the picture tube works, the television signal, the television receiver, antennas and tuners, how the video IF works, the video detector and AGC, the video amplifier at work, how the sync section works, horizontal output and high voltage supply, how the sound section works, how transistor portable TV's work. 224 pages, completely illustrated. Retail Price \$5.75.

### FUNDAMENTALS OF SEMICONDUCTORS

By M. G. Scroggie. Provides a complete background in semiconductor devices, beginning with basic facts on electrical conduction through transistors, rectifiers, photoelectric devices, thermistors, varistors, diodes, crysars, etc. Supplies enough theory in a simple way to make it possible to understand more advanced literature. Also explains how the special properties of semiconductors are being applied in many kinds of useful devices. Dozens of charts, diagrams and photos. 160 pages. Retail Price \$4.60.

### THE OSCILLOSCOPE

By George Zwick. (Revised Edition). Teaches you how to operate the scope, how to use it for alignment and shows you how to solve every type of service testing problem you are likely to encounter. Demonstrates how to interpret waveforms correctly, how to use scope probes, how to measure low input voltages, how to perform specific experiments using the oscilloscope, etc. 224 illustrated pages. Retail Price \$5.20.

Gernsback Library, Inc., Electronics Book Club, Dept. RE 17  
154 West 14th Street, New York, N.Y. 10011

Please enroll me in the Electronics Book Club and send me the 3 income-boosting handbooks: BASIC TV COURSE; FUNDAMENTALS OF SEMICONDUCTORS; THE OSCILLOSCOPE. Bill me only \$1.99 plus shipping (for this \$15.55 value). If not pleased, I may return the books in 10 days and this membership will be cancelled.

As a member, I need only accept as few as 4 additional books a year—and may resign any time after purchasing them. All books will be described to me in advance, every other month, in the Club Bulletin, and a convenient form will always be provided for my use if I do not wish to receive a forthcoming book. You will bill me the special Club price for each book I take (plus a few cents postage)—regardless of higher retail prices. Offer good in U.S.A. and Canada only.

Name ..... (Please Print)

Address .....

City ..... State ..... Zip Code .....

SAVE: Enclose your \$1.99 now with this coupon and we will pay postage. Same return guarantee privilege; prompt refund if not satisfied.



**NEW**  
FROM  
**ALLIED**

# *knight-kit*® *Safari*® II & III Citizens Band Transceivers

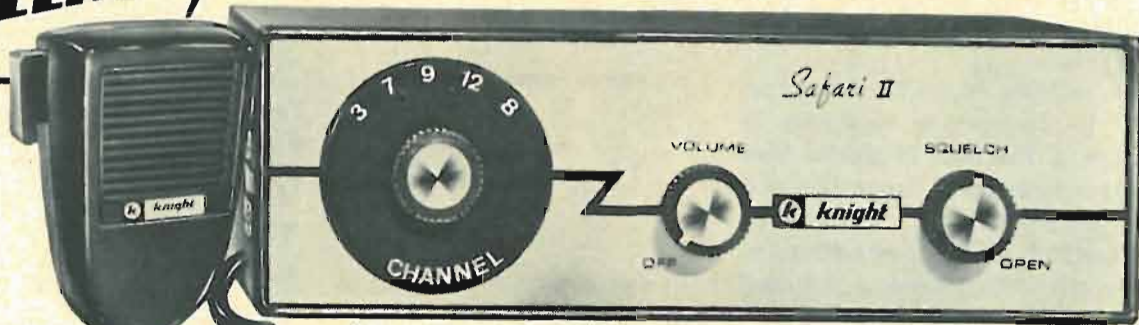

## *Safari II* 5-Watt 5-Channel Transceiver Kit

Versatile, easy and fun to build, features compact solid-state design with factory assembled and aligned transmitter section, yet is priced remarkably low. Full 5 watts input power, 5 crystal-controlled channels. Just 2 1/8 x 6 7/8 x 8 1/2" overall. Connects to 12-volt battery in car, truck or boat in minutes . . . use as portable with optional battery pack, or as base station with optional AC supply. Simple 3-control operation—illuminated channel selector, squelch control, on/off volume control. Series gate noise limiter circuit overcomes interference. Unique push-to-talk microphone/speaker.

With Mike/Speaker,  
Channel 9 Crystals  
**\$59.95**

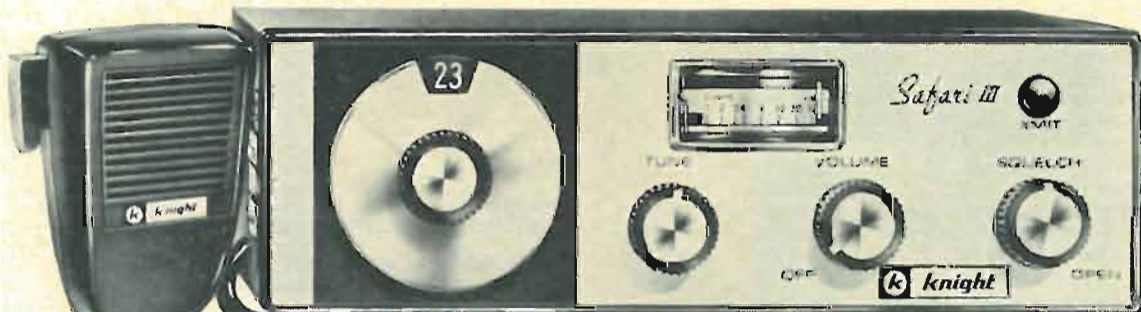

## *Safari III* 5-Watt 23-Channel Transceiver Kit

Designed for those who want the best in CB at a low price. All the deluxe features of the Safari II above . . . PLUS provision for 23 crystal-controlled channels; easy-to-read front-panel "S" meter and fine tuning control to tune in stations that are off frequency; and transmit indicator light.

With Mike/Speaker,  
Channel 9 Crystals  
**\$84.50**

Read the unique money-back guarantee below . . . exclusive in the industry . . . then rush the coupon for full details and Special Introductory Offer.

### **KNIGHT-KIT GUARANTEE**

Build a Knight-Kit in accordance with our easy-to-follow instructions. When you have completely assembled the kit, you must be satisfied or we will return your money, less transportation charges, under the Allied guarantee of satisfaction.

**ALLIED RADIO**

**ALLIED RADIO, Knight-Kit Div., Dept. 2-AA,  
P. O. Box 8528 Chicago, Illinois 60680**

Send me full details and Special Introductory Offer on the **Knight-Kit Safari II & III**.

Name \_\_\_\_\_  
PLEASE PRINT

Address \_\_\_\_\_

City \_\_\_\_\_ State \_\_\_\_\_ Zip \_\_\_\_\_



## RADIO-ELECTRONICS READER'S SERVICE

Here's how you can get manufacturers' literature fast:

1. Tear out the post card on the facing page. Clearly print or type your name and address.
2. Circle the number on the card that corresponds to the number appearing at the bottom of the **New Products, New Literature** or **Equipment Report** in which you are interested.  
For literature on products **advertised** in this issue, circle the number on the card that corresponds to the number appearing at the bottom of the advertisement in which you are interested. Use the convenient index below to locate quickly a particular advertisement.
3. Mail the card to us (no postage required in U.S.A.)

**Advertisements in this issue offering free literature (see the advertisements for products being advertised):**

AEROVOX CORP. (Pg. 26)	Circle 21		
ALLIED RADIO CORP. (Pg. 79)	Circle 37		
AMPEREX ELECTRONIC CORP. (Second Cover)	Circle 7		
ARROW FASTENER CO., INC. (Pg. 99)	Circle 136		
<b>B &amp; K MANUFACTURING CO. (Pg. 71)</b>	<b>Circle 31</b>		
BLONDER-TONGUE (Pg. 22)	Circle 17		
BRACH MANUFACTURING CORP. (Pg. 84)	Circle 107		
BROOKS RADIO & TV CORP. (Pg. 100-101)	Circle 138		
BURSTEIN-APPLEBEE CO. (Pg. 97)	Circle 133		
<b>CASTLE TV TUNER SERVICE, INC. (Pg. 6)</b>	<b>Circle 10</b>		
CLEVELAND INSTITUTE OF ELECTRONICS (Pg. 84)	Circle 109		
CLEVELAND INSTITUTE OF ELECTRONICS (Pg. 88)	Circle 115		
CORNELL-DUBILIER (Pg. 27)	Circle 22		
CORNELL ELECTRONICS CO. (Pg. 106)	Circle 146		
COYNE ELECTRONICS INSTITUTE (Pg. 103)	Circle 141		
<b>DELTA PRODUCTS, INC. (Pg. 70)</b>	<b>Circle 30</b>		
DATAK CORP. (Pg. 76)	Circle 28		
DE VRY TECHNICAL INSTITUTE (Pg. 7)	Circle 11		
<b>EASTMAN KODAK CO. (Pg. 25)</b>	<b>Circle 20</b>		
EDMUND SCIENTIFIC CORP. (Pg. 105)	Circle 143		
EICO ELECTRONIC INSTRUMENT CO., INC. (Third Cover)	Circle 149		
ELECTRO-TEK, INC. (Pg. 98)	Circle 123		
ELECTRO-VOICE, INC. (Pg. 66)	Circle 25		
<b>FINNEY CO. (Pg. 76)</b>	<b>Circle 27</b>		
FINNEY CO. (Pg. 99)	Circle 137		
<b>HEALD ENGINEERING COLLEGE (Pg. 99)</b>	<b>Circle 125</b>		
HEATH CO. (Pg. 74-75)	Circle 34		
<b>INTERNATIONAL CRYSTAL MFG. CO., INC. (Pg. 108)</b>	<b>Circle 148</b>		
INTERNATIONAL RADIO EXCHANGE (Pg. 85)	Circle 110		
<b>JERROLD ELECTRONICS CORP. (Pg. 89)</b>	<b>Circle 120</b>		
JFD ELECTRONICS CORP. (Pg. 14-15)	Circle 14		
<b>McGRAW-HILL BOOK CO. (Pg. 17)</b>	<b>Circle 16</b>		
MALLORY DISTRIBUTOR PRODUCTS CO. (Pg. 23)	Circle 18		
<b>MIKE QUINN ELECTRONICS (Pg. 93)</b>	<b>Circle 122</b>		
MILWAUKEE SCHOOL OF ENGINEERING (Pg. 68)	Circle 24		
MUSIC ASSOCIATED (Pg. 98)	Circle 124		
<b>OLSON ELECTRONICS, INC. (Pg. 102)</b>	<b>Circle 139</b>		
PERMOFLUX CORP. (Pg. 93)	Circle 121		
POLY PAKS (Pg. 107)	Circle 147		
<b>QUAM-NICHOLS CO. (Pg. 87)</b>	<b>Circle 113</b>		
<b>RADAR DEVICES (Pg. 1)</b>	<b>Circle 8</b>		
READING IMPROVEMENT PROGRAM (Pg. 101)	Circle 134		
RYE INDUSTRIES, INC. (Pg. 95)	Circle 131		
<b>S &amp; A ELECTRONICS INC. (Pg. 83)</b>	<b>Circle 106</b>		
SAMS, HOWARD W., CO. INC. (Pg. 24)	Circle 19		
SAMS, HOWARD W., CO. INC. (Pg. 73)	Circle 33		
SCOTT, H.H. INC. (Pg. 85)	Circle 100		
SENCORE (Pg. 87)	Circle 114		
SCHOBER ORGAN CORP. (Pg. 12)	Circle 12		
SHURE BROS. (Pg. 16)	Circle 15		
SOLID STATE SALES (Pg. 105)	Circle 144		
SPRAGUE PRODUCTS CO. (Pg. 67)	Circle 26		
SURPLUS CENTER (Pg. 98)	Circle 134		
SYLVANIA ELECTRONIC TUBE DIV. (Pg. 13)	Circle 13		
<b>TAB (Pg. 102)</b>	<b>Circle 140</b>		
<b>UNITED RADIO CO. (Pg. 104)</b>	<b>Circle 142</b>		
<b>WARREN ELECTRONIC COMPONENTS (Pg. 106)</b>	<b>Circle 145</b>		
WELLER ELECTRIC CO. (Pg. 96)	Circle 132		
WEN PRODUCTS, INC. (Pg. 94)	Circle 130		
WUERTH PRODUCTS CORP. (Pg. 86)	Circle 112		



# NEW PRODUCTS

More information on new products is available free from the manufacturers of items identified by a Reader's Service number. Turn to the Reader's Service Card facing page 80 and circle the numbers of the new products on which you would like further information. Detach and mail the postage-paid card.  
 Hz = hertz = cycles per second; kHz = kilocycles; MHz = megacycles

**KNIGHT-KIT VOM, model KG-640**, has 57 ranges, from 0.8 Vdc. Ac volts (12 ranges): 2, 4, 8, 16, 40, 80, 200, 400, 800, 1,600, 2,000, 4,000 full scale. Dc volts (12 ranges): 0.8, 1.6, 8, 16, 40, 80, 200,



400, 800, 1,600, 2,000, 4,000. Output volts (8 ranges): 2, 4, 8, 16, 40, 80, 200, 400 full scale. Resistance (3 ranges): 0-1,000, 100,000 ohms, 10 megs. Center scales at 12, 1,200 and 120K. Current (10 ranges): 80, 160, 400, 800  $\mu$ A; 8, 16, 200, 400 mA; 8-16 amps dc. Dc sensitivity: 20,000 or 10,000 ohms per volt (function of scale multiplier switch). Frequency response: 20 Hz to beyond 200 kHz. Accuracy: within 3% of full-scale reading on dc to 1,600 volts; within 5% on ac to 1,600 volts. Batteries: 1 standard C-cell, 4 standard penlight cells.—Allied Radio Corp.

Circle 46 on reader's service card

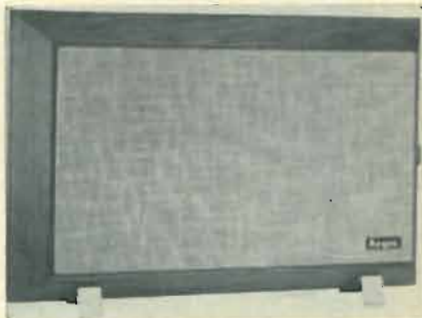

**HI-FI SPEAKER SYSTEMS**, the *Astra* and the *Solitaire*. *Astra* built on same design principle as sound column. Four speakers, 2 high-compliance Jensen woof-

ers, 2 direct-radiator tweeters. Response 50-17,000 Hz. Oil-finished walnut cabinet 33 $\frac{3}{4}$  x 10 $\frac{1}{2}$  x 4 in. *Solitaire* (see photo) designed to hang on wall or stand on own removable feet, for home or office use.

High-compliance Jensen woofer balanced and matched to separate direct-radiator tweeter. Built-in volume control. Oil-finished walnut cabinet 18 x 12 x 3 $\frac{3}{4}$  in.—Argos Products Co.

Circle 47 on reader's service card

**BASS-GUITAR SPEAKER SYSTEMS**, the *PMC-1* and *PMC-2*. Portable. Designed to obtain maximum performance from bass-guitar amplifiers. Design reduces cone travel for given amount of power; high efficiency allows lower volume control setting to deliver given amount of acoustical power without work-

Brand New  
and Exclusive!

Discriminates  
Between  
Desired  
Signal and  
Unwanted  
Noise!

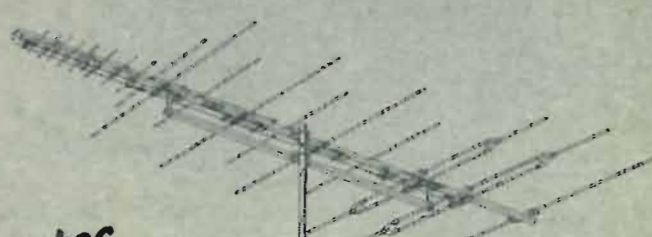

3-Way  
Combination

FREE SPACE  
STANDING WAVE  
MAGNETIC  
ANTENNA

(UHF-VHF-FM-COLOR)

Here for the first time, is an antenna with the unique ability to discriminate between the desired signal and unwanted noise! A complete absence of minor lobes and an extremely high front to back ratio are characteristics of these antennas. This is made possible by the development of the Free Space Standing Wave Magnetic Drive Antenna system (F.S.M.). The outstanding electrical qualities, combined with the simplified mechanical construction of this system yields a total performance package unparalleled in today's market. 4 models, 60-inch to 180-inch boom, all modestly priced.

There's a Quality Built S & A Antenna to Meet Every Need!

*S&A Electronics Inc.*

Manufacturers of the TARGET ANTENNA

210 West Florence St. • Phone (419) 693-0528 • Toledo, Ohio 43605



COLOR TV & UHF GHOSTS BEWARE

of the **Brach**  
LATEST "GHOST ENEMY"  
**UHF/VHF**  
**TV ANTENNAS**  
for Black/White & Color



- Ultimate in Design!
- Unequaled in Performance
- Outstanding in Value!

"GHOST ENEMY"  
Model #6702  
Gold Finish

Pinpoint tuning of UHF Loop with separate knob control.

Dept. Stores, Distributors & Television Manufacturers—Let us quote you on your PRIVATE BRAND requirements.

SEND FOR our latest catalog with our complete line of antennas

**BRACH MFG. CORP.**  
Div. of General Bronze Corp.  
899 Main Street, Sayreville, N.J. 08872

Circle 107 on reader's service card

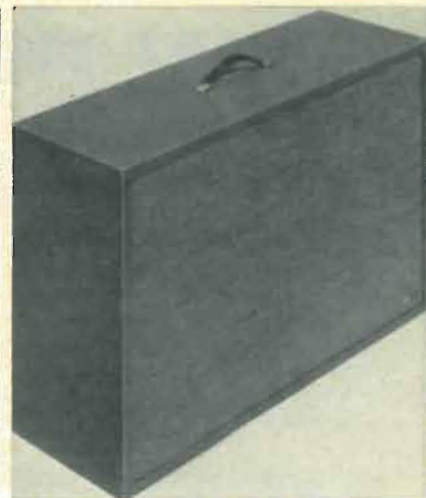

ing speaker at maximum capability. 12-in. speakers. 2-in. diameter voice coils, 2-lb magnets. *PMC-1* has 12-in. woofer, handles 60 watts. *PMC-2* has two 12-in. woofers, handles 120 watts.—Utah Electronics

Circle 48 on reader's service card

**CARDIOID DYNAMIC MICROPHONE**, model *M216*. Reduces feedback in PA, recording applications. Hermetically sealed cartridge. Cast-metal case.



Fits any stand with  $\frac{1}{8}$ -27 thread. Impedance: 50K ohms. Response: 100-12,000 Hz.  $1\frac{1}{2}$  x  $4\frac{1}{2}$  in. 20-ft shielded cable.—Olson Electronics, Inc.

Circle 49 on reader's service card



**PORTABLE 12V RECHARGEABLE POWER SOURCE**, the *CRL-1200 Power Pack*. Built-in charger. For wide range of applications. Continuous operation to

**LOOK! A NEW ELECTRONICS SLIDE RULE**  
with complete instruction program



Here's a great *new* way to solve electronic problems accurately, easily . . . a useful tool for technicians, engineers, students, radio-TV servicemen and hobbyists. The Cleveland Institute Electronics Slide Rule is the only rule designed *specifically* for the exacting requirements of electronics computation. It comes complete with an illustrated Instruction Course. You get four AUTO-PROGRAMMED lessons . . . each with a short quiz you can send in for grading and consultation by CIE's expert instructors.

See for yourself. Learn how to whip through

all kinds of reactance, resonance, inductance, AC and DC circuitry problems in seconds . . . become a whiz at conventional computations too!

This all-metal 10" rule is made to our rigid specs by Pickett, Inc. . . . comes complete with top grain leather carrying case *and* Instruction Course. A \$50 value for less than \$25. Send coupon for FREE illustrated booklet *and* FREE heavy vinyl Pocket Electronics Data Guide. Cleveland Institute of Electronics, 1776 E. 17th St., Dept. RE-135, Cleveland, Ohio 44114.

**GET BOTH FREE!**



**ELECTRONICS**

**SLIDE RULE**

**Send coupon today →**

**Cleveland Institute of Electronics**  
1776 E. 17th St., Dept. RE-135 Cleveland, Ohio 44114

Send FREE Electronics Slide Rule Booklet. Special Bonus: Mail promptly and get FREE Pocket Electronics Data Guide too!

NAME \_\_\_\_\_ (Please Print)

ADDRESS \_\_\_\_\_ COUNTY \_\_\_\_\_

CITY \_\_\_\_\_ STATE \_\_\_\_\_ ZIP \_\_\_\_\_

A leader in Electronics Training . . . since 1934

Circle 109 on reader's service card



40 hr or more, depending on current or wattage requirement of equipment used. Charging time 7 hr for 90% charge; 12 hr for complete charge. Operates from  $-30^{\circ}\text{F}$  to  $+122^{\circ}\text{F}$ . Not damaged by temperatures as low as  $-60^{\circ}$  or as high as  $+158^{\circ}\text{F}$ . Charge loss during storage 3% per month. Recharges to full capacity after 2½-yr shelf life. Two type RP-680 6-volt 8-amp/hr lead-silica-gel batteries; CRL-1000 solid-state automatic charger. Black leather carrying case.  $8\frac{1}{2} \times 2\frac{1}{2} \times 9$  in., 9½ lb.—Centralab, Electronics Div. of Globe-Union, Inc.

Circle 50 on reader's service card

**PORTABLE SOLID-STATE SPEECH SCRAMBLER**, the E75. Provides privacy over telephone land lines and radiotelephone circuits. Code card scrambles voice into any of 2,000 possible electrical speech patterns unintelligible to any-



one other than person with matching code card and identical equipment. No special technical knowledge required for operation. Switch controls. Power source 117 Vac, 12 Vdc. Packaged in standard attache case—Lynch Communication Systems Inc.

Circle 51 on reader's service card



**IN/OUT-OF-CIRCUIT TRANSISTOR TESTER**, the TR-139, checks transistors or diodes without disconnecting lead. Two readings: ac beta and leakage current ( $I_{e_{le}}$ ). In- and out-of-circuit pro-

# SCOTT



## Scott's new one-afternoon tuner kit delivers amazing FET Performance

Now you can get factory-wired performance from a kit that takes only one afternoon to build! Scott's new LT-112B is the only kit with Field Effect Transistor circuitry\*, enabling you to enjoy more stations more clearly. Interstation Muting Control effects complete quiet between FM stations . . . oscilloscope output allows laboratory-precise correction for multipath distortion.

For your free copy of Scott's 16-page full-color illustrated Guide to Custom Stereo, (circle Reader Service Number

Scott . . . where innovation is a tradition



"Scott's LT-112 . . . is one of the finest FM stereo tuners we have tested and it is easily the best kit-built tuner we have checked . . . Because of its simple construction and trouble-free nature, it is a logical choice for anyone who wants the finest in FM reception at a most remarkable price." HiFi/Stereo Review.

LT-112B specifications: Usable sensitivity, 1.8  $\mu\text{V}$ ; Cross modulation, 90 dB; Stereo separation, 40 dB; Capture ratio, 2.5 dB; Price, \$189.95.

\*Patents pending

Write to: H. H. Scott, Inc., Dept. No. 970-10, 111 Powdermill Road, Maynard, Mass. Export: Scott International, Maynard, Massachusetts.

Prices slightly higher west of Rockies. Subject to change without notice. We reserve the right to make changes and improvements without notice.

Circle 100 on reader's service card

## ATTENTION! CB OPERATORS

save on citizens radio equipment

### Discontinued Models From International Radio Exchange

Select that extra transceiver for mobile or base installation, or equip a new station. Our stock includes International types as well as other makes.

Write Today for A Complete List of Equipment in Stock



**RADIO EXCHANGE**  
18 NO. LEE, OKLA. CITY, OKLA. 73102  
Division Of International Crystal Mfg. Co.  
Dealing In Used Citizens Radio Equipment



Circle 110 on reader's service card



## ONLY CCTV CAMERA KIT ON THE MARKET

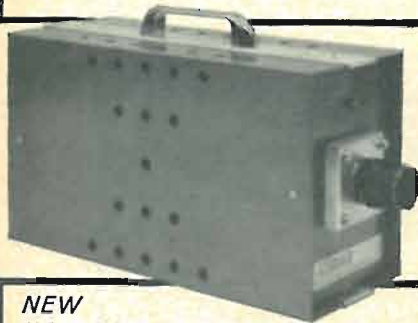

**NEW  
IMPROVED MODEL!**

- Vidicon
- 25mm. f1.9 Lens
- Cable
- Instructions

**\$209<sup>50</sup>**

**\$20 DOWN  
\$10 MONTH**

**ASSEMBLED \$259.50**

The affordable answer to an easy-to-use, top performing surveillance camera. Hundreds of uses in home, store, plant, office, hospital, school. Connects instantly to any TV set. Gives excellent picture with light from 150-watt bulb. Operates up to six sets. Complete — nothing else to buy. Optional lenses and tripod available.

All parts guaranteed one year. Vidicon guaranteed 90 days. Make check or money order to CONAR. Shipped REA collect.

**SEND FOR FREE CONAR CATALOG**

**CONAR** Division of National Radio  
Institute, Dept. AC7C  
3939 Wisconsin Avenue, Washington, D.C. 20016

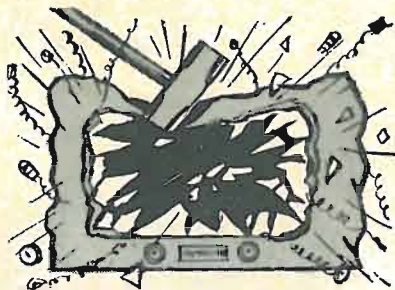

## STOP! WRECKING YOUR TV . . .

Inrush surge currents at 'Turn-On' destroy more TUBES, RECTIFIERS, and CAPACITORS than all other causes . . . EFFECTIVE, AUTOMATIC REDUCTION of the punishing inrush currents is immediately provided by the . . .

## WUERTH SURGISTOR®



117 V.  
AC-DC

Watts Range	Wuerth No.	Workman No.	G-C No.	Price List
100-275	4100-2	SR-1	25-894R	1.95
250-400	8050-4	SR-2	25-896R	2.95
300-500	8035-5	SR-3	.....	3.30
450-650	1025-6	.....	.....	4.95
600-850	1020-7	.....	.....	5.45
800-1200	1015-8	.....	.....	5.95
1170-1500	1010-9	.....	.....	6.95

Use SURGISTORS with your TV, Hi-Fi, Film Projector, or any other device requiring inrush surge current protection. SEE your distributor or dealer TODAY. Or, send order direct to us for prompt action.

**WUERTH PRODUCTS CORP.**

1931 Pembroke Road Hollywood, Florida

Circle 112 on reader's service card

cedures identical. Parameters of unknown transistors determined without setup book or manual.—Sencore, Inc.

Circle 52 on reader's service card



**POWER CONVERTER**, the *Power-maker*. Converts 12- or 24-volt battery power to 60 Hz ac; 300 watts continuous power. Accepts standard 2- or 3-prong plugs. Transistorized. Models available operating from 24-volt batteries to supply 400-Hz; also remote-control unit and automatic battery selector for 2-battery vehicles. 5½ x 6½ x 6¼ in., 11½ lb.—Topaz Inc.

Circle 53 on reader's service card

**MICROCIRCUIT TAPE PLAYER**, model M8610. Utilizes microcircuit in audio amplifier section. Plays 8-track stereo cartridges currently used in many automobile systems. Cartridge automatically switches at end of each program; repeats automatically until turned off.

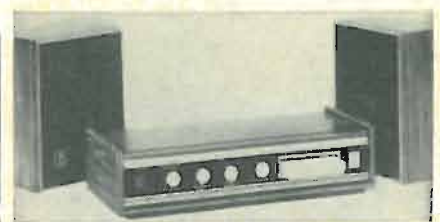

Pushbutton control. Shifts from one to another of 4 selections on 8-track cartridge. 9 x 6-in. stereo speakers. The model U8-600, not shown, plays through any stereo radio phonograph with standard input jacks. Tone, volume, balance are controlled through companion radio or amplifier. Cartridge component 4 x 8 x 1.8 in.—General Electric, Consumer Electronics Div.

Circle 54 on reader's service card

**AM-FM MULTIPLEX STEREO RECEIVER**, the ER-420. Tuned rf amplifier stage, 4 tuned i.f. amplifiers. Double cascade limiter for top and bottom clip-

# ACHIEVEMENT '67 IN ELECTRICAL/ ELECTRONICS ENGINEERING

**EXHIBITS  
NEW YORK  
COLISEUM**

**TECHNICAL  
SESSIONS  
NEW YORK HILTON**

Monday through Thursday  
**MARCH 20-23 1967**

- 69 Technical Sessions at the New York Hilton. Hours: Mon. 9:30-12:00 a.m.; 2:00-4:30 p.m. — other days 9:00-11:30 a.m.; 2:00-4:30 p.m.
- FOUR COMPLETE FLOORS OF EXHIBITS at the New York Coliseum including over 700 firms. Hours: 10 a.m.-8 p.m. 4 Days.
- Gala Annual Banquet — Wednesday 7:15 p.m. New York Hilton Grand Ballroom — \$15.00
- Free shuttle busses between the Hilton and the Coliseum — every few minutes.
- Registration — IEEE Members \$2.00 Non-members \$5.00 Ladies \$1.00 High School Students \$2.00 if accompanied by an adult. One student per adult Monday through Wednesday. Thursday only — limit of 3 students per adult. Good for all days — Technical Sessions and exhibits. In and out privileges.



**IEEE** '67 International  
CONVENTION / EXHIBITION





ping of noise pulses. Two-channel push-pull output; harmonic distortion at full rated output less than 1%. Frequency response essentially flat over audio range of 20-20,000 Hz. Low- and high-cut filters. Simultaneous tape recording jacks, tape monitor switch. Operates from 117- or 220-volt line. Front-panel earphone jack.—Pioneer Electronics U.S.A. Corp.

Circle 55 on reader's service card



**SPEAKER SYSTEM**, the *Baby Grand*. 3-in. tweeter, 5-in. styrene suspension-cone woofer. Frequency response: 40-20,000 Hz; input: 35 W; impedance: 8 ohms. Oiled walnut cabinet; leopard, tiger, zebra skin or standard grillecloth. 11½ x 6½ x 7¼ in.—Martel Electronics

Circle 56 on reader's service card



**NICKEL-CADMIUM DISC CELLS**, models S131, S132, S133. Built-in safety vent protects cell and equipment from charging malfunctions. Sintered negative and positive plates; porous structure increases volume of active material in direct contact with electrolyte. S131: 225-mA/hr cell; 0.985 x 0.350 in., 0.45 oz. S132: 150-mA/hr cell; 0.985 x 0.250 in., 0.35 oz. S133: 500-mA/hr cell, 1.350 x 0.360 in.,



...and the public address system will use QUAM speakers!



MODEL 8C10PA

For top quality public address. This 8" speaker has a 10 oz. ceramic magnet, frequency response of 55-13000 Hz., easily handles 12 watts. One of 34 Quam speakers for sound system applications.

Men who specify loudspeakers in enormous volume have to be particular about quality and performance. That's why more and more sound system installers are developing the habit of specifying Quam.

It's a good habit to acquire, because Quam makes good speakers for public address, background music and other sound system needs, as well as for radio-tv-automotive replacements.

Whatever kind of speaker you need, look for Quam, the Quality line, in the red, white, and blue package at your distributor.

**QUAM** QUAM-NICHOLS COMPANY  
234 E. Marquette Road—Chicago, Illinois 60637

Circle 113 on reader's service card

EVERY 8 MINUTES...



**SOMEONE BUYS A NEW SENCORE CG10 LO-BOY STANDARD COLOR BAR GENERATOR**

It's time you too switched to Sencore and saved \$100.00 in the bargain. The new compact LO-BOY is a solid Sencore value that outperforms the highest priced generators—and is already selling at the rate of one every 8 minutes.

Compare these features:

- Ten standard RCA licensed color bars plus all patterns found on more expensive generators.
- New patent pending counting circuits using silicon transistors. Crystal controlled timers for the utmost in stability.
- New front mounted timer controls for quick adjustment if they should ever jump. Absolutely eliminates timer instability.
- All solid state. Battery powered by long life "C" cells.
- HI in performance—LO in price. . . . (Less than the cost of a kit.) . . . only \$89.50

**SENCORE CG138 LO-BOY**—Just like CG10 except AC operated, 4.5 mc crystal controlled signal; recommended for troubleshooting. . . . only \$109.50



**SENCORE**  
NO. 1 MANUFACTURER OF ELECTRONIC MAINTENANCE EQUIPMENT

426 SOUTH WESTGATE DRIVE, ADDISON, ILLINOIS 60101

Circle 114 on reader's service card



0.95 oz. can be stacked in shrink-on plastic jackets to form batteries as shown.—Sontone Corp.

Circle 57 on reader's service card



**PAGING SYSTEM**, uses 8 D-batteries, 12-volt storage battery, or 110-220-Vac with adapter. Solid-state 15-watt amplifier, dynamic cardioid microphone, gooseneck support, press-to-talk base. Additional amplifiers, with own speakers, may be connected in series. System can be powered by one microphone.—Audio Div., American Gelsco Electronics, Inc.

Circle 58 on reader's service card

**2-BAND WEATHER RECEIVER**, the *Weatheradio*, tunes special weather frequencies as well as standard broadcast band. Weather band covers the FAA net-



work of reporting stations. Weather information transmitted continuously and can be tuned any time of day or night. 8-transistor receiver is also broadcast radio. 6 x 2½ x 3½ in., 14 oz.—Nova-Tech, Inc.

Circle 59 on reader's service card

## Now, for men in electronics —“a whole new era of quick calculation”

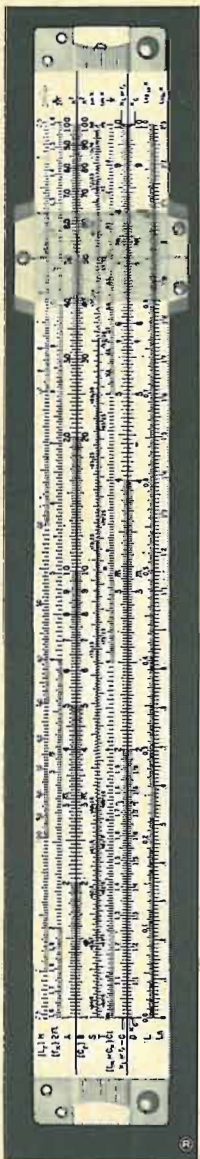

**T**HERE MUST BE THOUSANDS OF PEOPLE in electronics who have never had the marvelous adventure of calculating problems with a single slide rule; other thousands have had to content themselves with a slide rule not specifically designed for electronics. For both groups, the new slide rule designed and marketed by Cleveland Institute of Electronics and built for them by Pickett will open a whole new era of quick calculations.

“Even if you have never had a slide rule in your hands before, the four-lesson instruction course that is included takes you by the hand and leads you from simple calculations right through resonance and reactance problems with hardly a hitch. If you already use a slide rule, you’ll find the lessons a first-rate refresher course. And it explains in detail the shortcuts built into this new rule.”

From an article in  
**Radio Electronics Magazine**

Want complete details about this time-saving new Electronics Slide Rule? Just mail coupon below...or write Cleveland Institute of Electronics, Dept. RE-134, 1776 East 17th St., Cleveland, Ohio 44114.

Mail this coupon for  
**FREE BOOKLET**

How to Solve Electronics Problems in Seconds



With new Electronics Slide Rule and Instruction Course

**CIE** Cleveland Institute of Electronics  
1776 E. 17th St., Cleveland, Ohio 44114

Please send me without charge or obligation your booklet describing the CIE Electronics Slide Rule and Instruction Course. Also FREE if I act at once: a handy pocket-size Electronics Data Guide.

Name \_\_\_\_\_  
(please print)

Address \_\_\_\_\_

City \_\_\_\_\_ State \_\_\_\_\_ Zip \_\_\_\_\_

Accredited Member National Home Study Council  
A Leader in Electronics Training... Since 1934

RE-134

Circle 115 on reader's service card

**REPLACEMENT TV RELAYS** for specific television chassis. Nylon cams; glass-filled nylon bobbin and cover; acetyl copolymer material in integral molded platform/bearing and armature hinge to reduce friction. Stainless-steel antiresidual. Open, snap-on dust cover, or hermetically sealed construction.—Cornell-Dubilier Electronics Div.

Circle 60 on reader's service card

Write direct to the manufacturers for information on the item listed below:

**DX COMPUTER, W910P's Second Op**, revised, fourth edition. Durable, laminated card stock. Provides beam headings to every country in world from major geographic locations in U.S.; immediate identification of prefixes with specific lo-

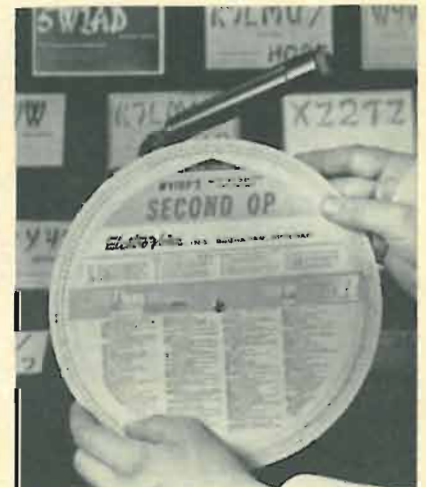

cation of prefix, time zone, continent, postage rates. Provisions for logging contacts, receipt of confirmation.—Electro-Voice, Inc., 600 Cecil, Buchanan, Mich. 49107

END



# NEW LITERATURE

All booklets, catalogs, charts, data sheets and other literature listed here are free for the asking with a Reader's Service number. Turn to the Reader's Service Card facing page 80 and circle the numbers of the items you want. Then detach and mail the card. No postage required!

**OSCILLOSCOPE, PLUG-INS BROCHURE**, 20 pages, looseleaf-punched. Describes model 777 dual-beam high-frequency oscilloscope, 20 plug-ins, accessories. Specifications. Illustrates cross sampling of display capabilities of combinations of plug-ins.—Fairchild Instrumentation, Div. of Fairchild Camera & Instrument Corp.

Circle 61 on reader's service card

**UNDERWATER COMMUNICATIONS EQUIPMENT BOOKLET**, 4 pages. Describes equipment for submersibles, underwater stations and ranges, surface vessels, divers. Specifications, some illustrations.—Underseas Div., Westinghouse Defense & Space Center

Circle 62 on reader's service card

**COLOR TV TEST EQUIPMENT**, the Commander line. Spec sheets, looseleaf-punched. Includes photographs, accessories and applications.—Amphenol Corp.

Circle 63 on reader's service card

**1967 STEREO COMPACT GUIDE**, 16-page brochure. Explains stereo hi-fi and how it works. Complete color photos, descriptions, specifications. Full line of components.—H. H. Scott, Inc.

Circle 64 on reader's service card

**1967 PLAYBACK STEREO COMPONENTS AND SYSTEMS CATALOG**, No. AL-1353, 10 pages. Illustrations, specifications on full range of products. Includes high-style equipment cabinets.—Altec Lansing

Circle 65 on reader's service card

**GENERAL CATALOG**, No. 18, Barry's Greensheet, 71 pages. Variety of electronic equipment, components, accessories. Includes miscellaneous items. Tube price list.—Barry Electronics Mail Order Corp.

Circle 66 on reader's service card

## Having Trouble With Winter Starts

Here's a modern device you can build for \$25! Saves your points, makes your plugs fire, even with a load of carbon fouling them. Full instructions in

**FEBRUARY RADIO-ELECTRONICS**

**PRESS-TO-TEST INDICATOR LIGHTS**, Catalog L-201, 4 pages, looseleaf-punched. Subminiature, miniature. Meet or exceed requirements of MIL-L-7961B, MIL-L-3661. Lamp-selection charts for lamps employed by indicators (T-134, T-3¼ incandescent lamps). Complete data, descriptions, drawings, new number designations.—Dialight Corp.

Circle 67 on reader's service card

**FREQUENCY MEASUREMENT EQUIPMENT, ACCESSORIES CATALOG**, 23 pages. Illustrations, applications, diagrams. Complete descriptions. Installation, operation manual.—General Radiotelephone Co., Instrumentation Div.

Circle 68 on reader's service card

**CB CATALOG**, 11 pages, looseleaf-punched. Base-station antennas, matchers, special cables,

leads, body mounts, springs, special mounts, accessories. Descriptions, illustrations.—New-Tronics

Circle 69 on reader's service card

**HI-FI HEADPHONES BROCHURE**, 3 pages. Binaural, monaural, with boom microphones. Replacement parts. Accessories. Descriptions, illustrations, price lists.—Permoflux

Circle 70 on reader's service card

Write direct to the manufacturers for information on the items listed below:

**LAMP CATALOG**, No. 104, 11 pages. Miniature, subminiature, microminiature lamps meet industry standards. Illustrations, diagrams. Quick-reference tables include base design, design voltage, approx. candlepower, hr. of life, dimension.—Hudson Lamp Co., 528 Elm St., Kearney, New Jersey 07032

END

improves color reception  
3 ways...

NEW  
JERROLD

## PARALOG Plus™

- 1. Plus GAIN**—provides sharper directivity to eliminate color ghosts.
- 2. Plus FLATNESS**—eliminates tilts which cause incorrect colors on the TV screen. Industry experts say that color antennas must be flat within  $\pm 2$  db. Paralog-Plus antennas are flat within  $\pm 1$  db per channel.
- 3. Plus MATCH**—to prevent color-distorting phase shifts.

To give you these *exclusive* color features Paralog-Plus has a unique Bi Modal Director system that actually works on high and low band channels simultaneously, making each element serve double duty.

What's more, you get a choice of 300 ohm and 75 ohm coaxial outputs, *plus* excellent gain over the entire FM band. For the greatest realism in lifelike color, try the Paralog-Plus.

JERROLD ELECTRONICS CORPORATION  
DISTRIBUTOR SALES DIVISION  
401 Walnut St., Phila., Pa. 19105

Circle 120 on reader's service card







# Where's the first place to look for electronic ideas? See the Gernsback book rack at your local parts distributor for facts, tips, hints, answers & know-how!

When you need professional help on tough electronics problems, go directly to the Gernsback Library Book Rack at your favorite electronics parts distributor. Here you'll find answers on radio and TV servicing, transistors, hobby projects, test instruments, audio, hi-fi, stereo, tape recording, communications, industrial electronics, to name just a few areas. Each book is designed to give you practical assistance in the field you desire. Examine the recent titles below.



### New Skill-Building Transistor Projects and Experiments

By Louis E. Garner, Jr. This unusual handbook helps you discover everything about transistors by actually doing things with transistors. Shows how to conduct experiments to gain new facts and prove key points. You'll assemble your own circuits, make your own tests, draw your own conclusions based on the knowledge you've acquired. Projects include: headphone amplifier, hi-fi preamplifier, power megaphone, cigar-box portable, electric eye, rain alarm, etc. 192 value-packed pages.

Order #129 ..... Softbound \$2.95



### Color TV Repair

By 10 Servicing Experts. Top technicians like David R. Anderson, Ed Bukstein, Jack Darr, Homer L. Davidson, Art Margolis, Robert Middleton and Warren Roy have created here an important tool for the profit-minded service technician. Tells you clearly and concisely just what can go wrong in color TV receivers and how to fix them. First each trouble symptom is described in detail, then a perfect solution is provided for the problem. Book covers color circuits. ABC's of color TV servicing, antennas and boosters, replacing the color picture tube, how to pinpoint the defective color section fast, servicing the chroma circuits, unexpected causes of TV color failure, troubleshooting with a color bar generator, color servicing tips, plus a glossary of color TV terms. 106 pages.

Order #123 ..... Softbound \$2.95

### Servicing AGC Circuits

By Harry E. Thomas. This practical how-to-do-it manual first shows you everything that can go wrong with AGC circuits and then goes on to reveal all you need to know to correct the trouble. Enables you to locate breakdowns quickly in AGC circuits, and then make your repairs rapidly and intelligently. Specific service approaches are plainly spelled out so you can use them immediately. Special emphasis is placed on TV troubleshooting, giving you the devices and techniques used in modern circuitry. Easy-to-read explanations, helpful illustrations. 204 pages, available through parts jobbers only.

Order #126 ..... Softbound \$3.95



### Probes for Test Instruments

By Bruno Zucconi and Martin Clifford. A probe is a link. It is a device you connect between a test instrument like a scope or v.t.v.m. and a radio or TV set being repaired. The finest scope or v.t.v.m. is limited by the kind of probe you use, and by how much you know about putting probes to work for you. Now comes this valuable handbook showing you in clear detail exactly what probe to use for a particular job. Covers crystal-demodulator probes, voltage-doubler probes, balanced probes, low-capacitance probes, high-voltage probes, isolation probes, direct probes, specialized probes, vacuum-tube and semiconductor probes. 224 pages, newly revised.

Order #54 ..... Softbound \$2.50

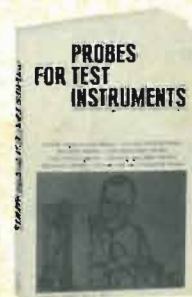

### The Handbook of Electronic Tables

By Martin Clifford. Here is an effective new approach to solving electronics problems. You don't have to make mathematical computations, or carry a slide rule or memorize any formulas whatsoever. Every answer you will ever need is worked out for you in 160 fact-packed pages of accurate electronic tables. Simply take the figures of your electronics problems and turn to the appropriate table. Then move your finger across the table and read the answer, instantly. You'll find these tables are easy to use, offer a wide choice of solutions and provide a high degree of accuracy.

Order #125 ..... Softbound \$2.95

**Get These Books At Your Parts Distributor or Mail This Coupon**

Gernsback Library Inc., Dept. RE 17  
154 West 14th Street, New York, N.Y. 10011

Please send the books checked below. I enclose \$.....

(Prices 10% higher in Canada)

- 129 (\$2.95)       123 (\$2.95)  
 54 (\$2.50)       125 (\$2.95)

Name .....

Address .....

City .....State.....Zip.....

My Distributor is .....



# R-E PUZZLER

Try this electronics word puzzle based on electronics terms.

Perfect score is 100; give yourself 4 points for each correct word you fill in.

- |   |  |   |
|---|--|---|
| <p>1 Precise matching of two waves or functions.<br/>                 2 Has the force that attracts ferrous metals.<br/>                 3 Tubular coil for producing a magnetic field.<br/>                 4 Substance capable of transmitting electricity.<br/>                 5 Tube containing anode, cathode, control electrode and two grids.<br/>                 6 Aids more accurate measurement or adjustment.<br/>                 7 Radiates electromagnetic and electrostatic fields.<br/>                 8 Opposition to the flow of alternating current.<br/>                 9 Element to stir up electron</p> | <p>emission in tubes.<br/>                 10 Fitting for making electrical connections.<br/>                 11 Outermost area of TV reception.<br/>                 12 Ability to receive, contain, or absorb.<br/>                 13 Two million changes every second.<br/>                 14 Conveyor of communication information.<br/>                 15 Permits certain range of frequencies, suppressing others.<br/>                 16 Unit of quantity of electric charge in MKSA system.<br/>                 17 One of three elementary particles.</p> | <p>18 Unit of movement of electrons.<br/>                 19 Way of showing circuit, parts, assemblies.<br/>                 20 Helical or spiral devices that retard or prevent changes in current flow.<br/>                 21 Actuates auditory nerves.<br/>                 22 Constituent part or assembly.<br/>                 23 Sinusoidal wave with frequency that is multiple of another.<br/>                 24 Balances out internal feedback voltage of high-gain amplifier stage.<br/>                 25 Radiation pattern of a vertical antenna.</p> |
|---|--|---|

Solution next month



## PERMOFLUX . . . WILL GO TO YOUR HEAD . . . IF . . .

you're seeking the ultimate in frequency response, superior engineering and durability. Write today for the dealer nearest you. A demonstration will prove to you why Permoflux headphones are used by the leading experts in all professions where sound is foremost.

*All ear speakers are fully warranted for life.*

STANDARD OF THE WORLD



P.O. Box 6364, Dept. RE 1  
GLENDALE, CALIFORNIA

Circle 121 on reader's service card

## INTEGRATED CIRCUIT SALE PRICES YOU CAN AFFORD

- IC's TO-5 case, 6-8-10 lead, include Gates Buffers, Flipflops etc. Asstd. 100. . . . . \$10.00
  - IC's Flat Packs—some as above Asstd. 100. . . . . \$12.50  
(All IC's sample tested over 50% good) test info. included.
  - Hi-gain (Darlington) Amplifiers TO-18 similar 2N998, 2N999. 6 for . . . . . \$2.95
  - P Channel Field Effect Trans. Similar 2N3277, 78 TO-5. 3 for . . . . . \$2.95
  - NPN HV, Hi power Amplif., 20MHz 30 watts TO-59 stud similar 2N2897. 6 for . . . . . \$2.95
  - NPN Power Trans. Asstd. TO-59, DO-3 DO-66, 6 for . . . . . \$2.95
  - SCR's 8 amp TO-59 stud, similar 2N3269, 70, 71, 72. 100 to 400 PIV. 6 for . . . . . \$2.95
  - Pancake Trans. tiny TO-46 PNP or NPN, 30 for . . . . . \$2.95
  - Dual 6 lead TO-5 NPN or PNP, Diff Amplif. Dual Switch, Choppers, similar 2N2915-18, 2N3726, 6 for . . . . . \$2.95
  - Dual 6 lead TO-18 NPN only, similar above & Dual 2N706, 6 for . . . . . \$2.95  
100 duals, choice for . . . . . \$25.00
  - Signal Diodes Asstd Glass & Min. black dot few Zeners. Sample tested, aver 100 good.. \$2.95
  - Giant Assortments Sample Tested 80% good. 1000 all Transistors TO-5, TO-18, TO-46. . . \$19.50
  - 1000 as above but including also 6 lead Trans, Darlington's, IC's, FET's, few diodes. . . . \$19.50
- Above Assortments Sample Tested as noted  
Other Assortments Fully tested & Grd.
- All devices sold are Diffused Silicon Planer
- Free GOODY bag with 2 or more assortments

Send Postage for Amazing Free Catalog

All Cash orders sent Postpaid, COD's 25% deposit  
Californians add 4% Sales Tax

## MIKE QUINN ELECTRONICS

Building 727 Langley Boulevard  
Oakland Airport, California 94614

Circle 122 on reader's service card



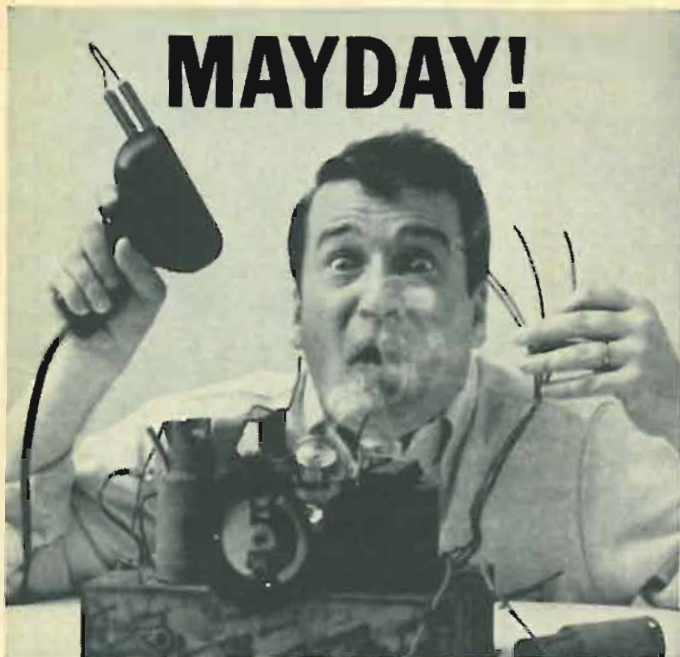

# MAYDAY!

Don't go to pieces...  
even if your soldering did! Next time

## USE A GOOF-PROOF WEN SINGLE-POST SOLDERING GUN!

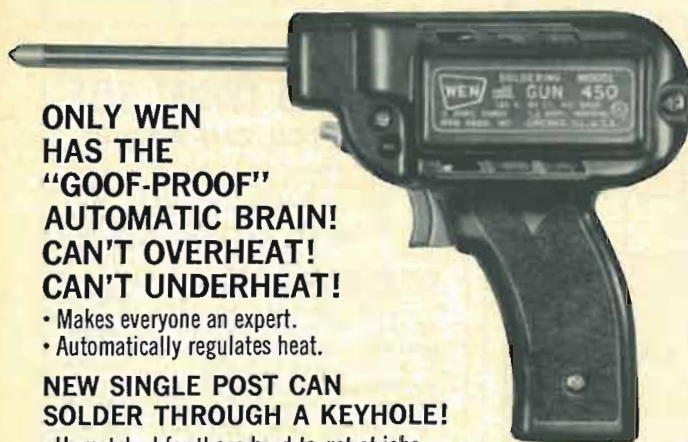

**ONLY WEN  
HAS THE  
"GOOF-PROOF"  
AUTOMATIC BRAIN!  
CAN'T OVERHEAT!  
CAN'T UNDERHEAT!**

- Makes everyone an expert.
- Automatically regulates heat.

**NEW SINGLE POST CAN  
SOLDER THROUGH A KEYHOLE!**

- Unmatched for those hard-to-get-at jobs.
- Reduces risk of melting fragile components.
- Single post won't bend from overheating.

**START AS LOW AS \$4.95!**

- WEN's 3-in-1 Gun delivers from 25 to 450 watts of heat power.
- See the complete line at your dealer.
- Send for free brochure.

**WEN PRODUCTS, INC.  
5810 NORTHWEST HIGHWAY,  
CHICAGO, ILL. 60631**



**WEN PRODUCTS, INC. — DEPT. 51  
5810 NORTHWEST HIGHWAY, CHICAGO, ILL. 60631**

Please send colorful **FREE** brochure on WEN's complete line of Soldering Guns . . . and other WEN tools!

Name \_\_\_\_\_

Address \_\_\_\_\_

City \_\_\_\_\_ State \_\_\_\_\_ Zip Code \_\_\_\_\_

I now own a soldering  GUN  IRON  PENCIL  NONE

Circle 130 on reader's service card

## The Trouble That Couldn't Happen

By **MILTON LOWENS**

Part I—The Problem

MR. GOLDSMITH'S VOICE OVER THE TELEPHONE SOUNDED frantic. "Election day and my TV is crazy. Can you help me out? I'll pay double time—anything—to watch the returns tonight."

"Well, I'm pretty busy. Do you have any sound?"

"Oh, the sound is fine. So is the picture. Except for one minor detail."

"What's that?" I asked, beginning to feel a bit annoyed. Could this be just a perfectionist crank with no real emergency?

"Well, I have a good picture, but it's upside down."

I wasn't sure I understood.

"Upside-down? What do you mean?"

"Just what I said. Upside-down. The picture would be fine if I stood on my head. It might be more comfortable if I turned the TV upside down, though."

I could hear the smile on the customer's face. I tried another tack.

"What did you do to the set?" I asked sternly, figuring that somehow the yoke must have been turned 180 degrees. Maybe this was a do-it-yourself amateur job gone wrong.

"Nothing!" the voice sounded sincere. "I haven't touched the set. It's 3 years old and this is the first time we ever had trouble with it. The back has never been off; no tubes have been changed. You know we've been your customers for years. We never call anyone else. How about helping us out now?"

"I'll be over in an hour." My curiosity was stirred, as well as my desire to help. "By the way, what kind of set is it?"

"A big Magnavox. It had a beautiful picture. We were watching a Western, I think, when the picture collapsed into a horizontal line for a moment and then opened up again—but upside down. We thought there might be something wrong at the TV station so we switched around. But all the channels were upside down. That means the trouble must be in the set, doesn't it?"

"Certainly seems that way. You wouldn't know the model number, off hand?" I wanted to check the schematic before I went over.

"No, I'm sorry," was the reply. "It's a big stereo-hi-fi combination. Too heavy for me to move to see the back."

"Okay, it's not too important. By the way—did you notice any burning smell or any change at all in the sound when the trouble came?"

"No, nothing like that at all. Matter of fact, the set is playing right now, upside-down picture and all. My youngster likes it that way. Says it's different, for a change. Is it okay to leave it on?"

"Sure." I figured whatever the trouble, it had stabilized and I wanted to see it as it was. I had seen too many peculiar troubles that disappeared between the phone call and my service call. "I'll see you in an hour or two."

I wasn't really busy at all, but Mr. Goldsmith might as well figure I was doing him a favor. I had taken the day off and had lots of time. I had voted already. I wanted the time to think this one over. In my TV service training we always stressed the importance of careful diagnosis, of thinking through a problem before tackling it.

So, I started to figure. An upside-down picture could result from reversed leads to the vertical deflection coils. That would change the phase of the vertical sweep by 180°. But if nobody had touched the yoke or its leads, then I must look



for other causes of the 180° phase shift. What causes such shifts? Amplifiers! I could almost hear a student reciting. "Every time a signal passes through an amplifier its phase is shifted 180°." That must be it! One of the vertical amplifiers must have failed in such a way as to pass the signal without amplifying it. Therefore no reversal of phase as required and the picture is upside down. So the elaborate problem must be a simple tube change. It wouldn't take long. I glowed inside.

Mr. Goldsmith greeted me warmly, and led me to his big, well-furnished living room without delay. There it was, just as he had said: A teen-ager on the sofa, his heels against the wall where his head should have been; his head hanging over the edge of the cushion. He was watching the picture; it was upside down. "Sure is strange," I admitted. Might as well be frank. "I've never seen anything like it before."

I studied the picture intently. Mr. Goldsmith's technical description had not been quite accurate. The picture was not normal. There were clear retrace lines, and vertical deflection was about two-thirds of what it should have been to fill the screen. There was no evidence of any foldover, but the top of the picture (where the heads were) was compressed. The vertical linearity control corrected the distortion at the further expense of height. Still, insufficient vertical deflection seemed to confirm my theory of tube failure, so I couldn't wait to get the back off and change a tube or two.

While I was at it, I noticed that all the screws were tight; none were missing. No, this was a virgin set. My early suspicions about someone tampering were unjust. To be extra sure, though, I quickly checked the yoke leads, looked at the plug that connected the yoke to the chassis to make sure it had not been plugged in wrong, and the yoke clamp, too. Everything was as it must have been when it left the factory. Might as well change the tubes in the vertical circuit. The tube layout chart indicated only one possible suspect: a 6CM7 twin-triode used as vertical oscillator and output. Without shutting off the set, I plugged a new tube into the socket and watched the bright horizontal line intently as the tube warmed up. Mr. Goldsmith watched too. The line expanded, the picture rolled a bit and locked in solidly, as before. Upside-down!

There was nothing left but to lend Mr. Goldsmith the little portable I keep in my truck for such occasions, and pull the chassis.

Back in my workshop, I couldn't wait to get the set hooked up. After all, my theory about the defective amplifier stage still was tenable. Even if the tube was okay, there might be some kind of a grid-plate short in the socket or printed circuit which might feed the vertical oscillator output directly to the yoke: hence insufficient height and no phase reversal. I turned the set on. The sound came on first, loud and clear. I had hit a station break. Then as the picture jelled, I almost fell off my stool. No, the picture was still upside-down; but it was backward, too—a mirror image, just as if the leads to the horizontal deflection coils had also been reversed. *Both sweeps*, horizontal and vertical, were 180° out of phase. For a moment I thought I might have put the yoke onto the neck of my test picture tube backwards, but no such luck; it was a 90° yoke and the big flare at the front made mistakes impossible. My theory was falling apart fast. A few voltage checks demolished it. Every voltage was exactly as specified by the manufacturer!

The widely experienced TV service technicians who serve as electronics instructors at Gompers Vocational were skeptical when I told them about Mr. Goldsmith's upside-down-backward picture at lunch the following day. The consensus was that the customer was pulling my leg.

"I wouldn't believe him, Milt," George said. "This guy must have had trouble and called someone else. Now he's ashamed to admit it. Chances are that they had a fight about



## A clever tape file

Stores 5 reels in one sturdy plastic case with swing-out compartments. Protects these valuable tapes, keeps them handy, indexed and orderly. Stacks horizontally or vertically, comes in three sizes (for 3-, 5-, 7-inch reels). Handsome two-tone beige. (A neat 8-mm film file too!)

3": \$2.99  
5": \$4.45  
7": \$4.95  
(all prices less reels)



Available through your local distributor, or write to:

**RYE INDUSTRIES INC.**

130 Spencer Place, Mamaroneck, N.Y. 10543

Circle 131 on reader's service card

# EIGHT INSTRUMENTS IN ONE

- Out-of-Circuit Transistor Analyzer
- Dynamic In-Circuit Transistor & Radio Tester
- Signal Generator
- Signal Tracer • Voltmeter
- Milliammeter
- Battery Tester
- Diode Checker



## Transistor Analyzer Model 212

Factory Wired & Tested — \$19.50  
Easy-to-Assemble Kit — \$13.50

**YOU DON'T NEED A BENCH FULL OF EQUIPMENT TO TEST TRANSISTOR RADIOS!** All the facilities you need to check the transistors themselves — and the radios or other circuits in which they are used — have been ingeniously engineered into the compact, 6-inch high case of the Model 212. It's the transistor radio troubleshooter with all the features found only in more expensive units. Find defective transistors and circuit troubles speedily with a single, streamlined instrument instead of an elaborate hook-up.

### Features:

Checks all transistor types — high or low power. Checks DC current gain (beta) to 200 in 3 ranges. Checks leakage. Universal test socket accepts different base configurations. Identifies unknown transistors as NPN or PNP.

Dynamic test for all transistors as signal amplifiers (oscillator check), in or out of circuit. Develops test signal for AF, IF, or RF circuits. Signal traces all circuits. Checks condition of diodes. Measures battery or other transistor-circuit power-supply voltages on 12-volt scale. No external power source needed. Measures circuit drain or other DC currents to 80 milliamperes. Supplied with three external leads for in-circuit testing and a pair of test leads for measuring voltage and current. Comes complete with instruction manual and transistor listing.

EMC, 625 Broadway, New York 12, N. Y.

Send me FREE catalog of the complete value-packed EMC line, and name of local distributor.

NAME \_\_\_\_\_ RE-1

ADDRESS \_\_\_\_\_

CITY \_\_\_\_\_ ZONE \_\_\_\_\_ STATE \_\_\_\_\_

# EMC

ELECTRONIC MEASUREMENTS CORP.  
625 Broadway, New York 12, New York

Export: Pan-Mar Corp., 1270 B'way, N.Y. 1



Now there's a full line of

Weller®

## Soldering Tools for all soldering needs

Each model outperforms any other soldering tool of comparable size and price. All have replaceable tips of solid copper, instant heat, long reach, and rugged construction that means long-life, dependable performance.



### Weller Dual Heat Guns

Feature trigger-controlled dual heat, efficient double-barrel design, long-life tip, and work spotlight. Available in three wattage ratings, and in handy soldering gun kits. Priced from \$6.95 list.

### Weller MARKSMAN Irons

Best for intricate soldering or continuous-duty operation. Five sizes—all lightweights—with replaceable, premium-plated  $\frac{1}{8}$ " to  $\frac{5}{8}$ " tips. From \$2.98 list. Also in complete kit form with a soldering aid, solder and 2 extra soldering tips.



Try them all . . . at your electronic parts distributor!

**WELLER ELECTRIC CORP., Easton, Pa.**  
WORLD LEADER IN SOLDERING TECHNOLOGY

Circle 132 on reader's service card

the price or something and the serviceman switched the leads on the yoke to get even because he didn't get the job."

"What about the retrace lines and insufficient height? Switching yoke leads wouldn't cause that," I replied.

"True," Manny chimed in, "but maybe that was the trouble to begin with. Why don't you troubleshoot that and stop worrying about the reversed sweeps? You know there isn't one chance in a million for both to go bad at the same time in the same way. And there's nothing in common between the horizontal and vertical sweep except the power supply and sync. I can't see how either would cause an upside-down and backward picture."

"But I could swear that the customer isn't the kind of man to kid me. I *know* him. And besides, I think I can recognize a factory soldered lug and one that has been altered. And the back, with all its screws. And the chassis mounting screws, factory-tight . . ."

"So, what's all this factory stuff?" Irv broke in. "Why don't you call Magnavox Technical Service and see what they say about your story? I'll bet they laugh at you!"

Irv was right. They did.

The technician was incredulous. "Never heard anything like it," he said. "Are you sure no one switched the yoke leads?"

It was beginning to have a familiar ring. "No, I checked that first."

"How about the plug from the yoke? It's an octal tube base. Is the key broken off? Maybe it's plugged in wrong."

"No," I sighed. "I checked that too."

"And you say the picture is normal except for retrace lines and height? How about foldover at top or bottom?"

"No foldover—only distortion. And of course the picture is upside down and backwards."

"Yes, you said that." He sounded annoyed. "Did you check the blanking circuit? It's tied in with the vertical output autotransformer."

"No," I replied. "All I know is that the tubes and voltages check okay."

"Well, I don't see how the blanking circuit could reverse everything, but I'd start there anyway. You have to start someplace."

"All right," I said sadly. "I'll start there, but what do I tell the customer if it turns out to be a blind alley?"

"I don't know. I just don't know. I never heard of such a trouble. Are you *sure* no one reversed the yoke leads . . ."

At the test bench that afternoon, I turned on my scope only to have the fuse blow. What a time for the scope to go bad. "Oh well, let's see, the blanking circuit . . ." I said to myself as I studied the schematic. "A 40-volt negative spike comes from the bottom of the vertical output autotransformer and is coupled to the grid of the picture tube via a .0033- $\mu$ F capacitor. Of course, since the video signal is applied to the cathode, the spikes cut off the tube during retrace."

I turned on the set and studied the prominent retrace lines. They were thick and heavy, not at all like the faint lines you sometimes see when you turn down the contrast. I tried the contrast and brightness controls. They had little effect on the retrace image.

"Oh well," I figured, "I can't see the blanking spikes since my scope is out, so let's see what happens if I remove them by disconnecting the .0033- $\mu$ F coupling capacitor."

Can you guess what happened?

Did you say the picture reversed itself twice to become normal? Sorry, no such happy ending in this real-life problem. But the heavy retrace lines *did* disappear. And that led me straight to the trouble. Can you figure out what it was?

SOLUTION NEXT MONTH



# TECHNOTES

## RCA CTC5—VERTICAL ROLL DURING WARMUP

From cold start picture rolls very fast but can be stopped temporarily with hold control. As set warms up, hold control must be readjusted to hold sync. This continues for about an hour or until temperature stabilizes. This symptom can be caused by slow-heating tubes in the vertical oscillator, vertical output and damper stages but I've also found two capacitors that can cause the same symptoms.

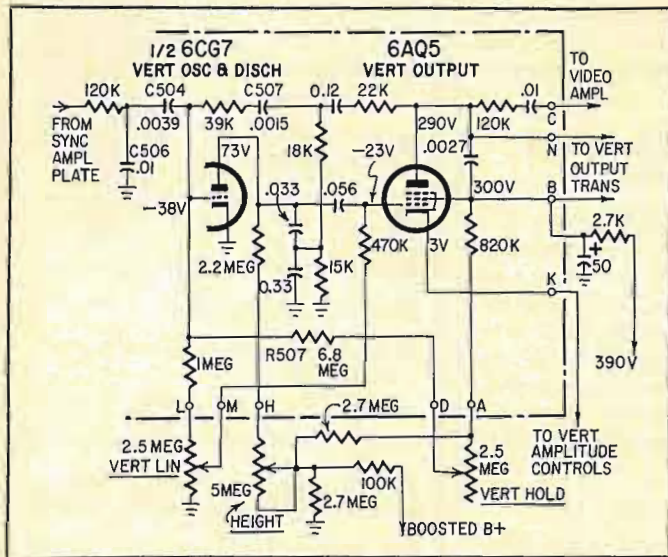

These are C504 and C507 (see diagram). Slight leakage, around 50,000 megs, detectable only with a good capacitor analyzer, is responsible for the trouble. For best results, replace with temperature-stable capacitors such as the Sprague Isosfarad 5BF type. While you are at it, check C506. Leakage here will cause soft vertical roll.

If the picture still rolls when the hold control is at the end of its range, check R507 for correct value.—*V. Karitons*

## ADMIRAL 25-INCH COLOR—WIDTH COIL

Recent 25-inch color chassis have a coil, part 73B31-14, to limit the width. This coil is located below the chassis and is connected between terminals 1 and 3 of the flyback transformer. These sets will operate without the width coil if a replacement is not immediately available. There will be some overscan.—*Admiral Service News Letter*

## GENERAL ELECTRIC CB CHASSIS

Complaints of no color, intermittent or incorrect color have been traced to a defective neon lamp in the grid circuit of the burst gate. The lamp will not light or will flicker and will usually appear black on the internal electrodes. The original NE-2 should be replaced by the rugged NE-83/5AH. If unavailable, use an NE-2H.—*General Electric Service Talk*

## RCA CTC16—DIM PIX, SMALL RASTER

The picture was barely visible and the raster was only 6–8 inches high. Screen, height and linearity controls inoperative; high voltage normal. The trouble was traced to an open 100K ½-watt resistor from the boost rectifier to the screen controls. It supplies the boosted-boost line to the vertical sweep circuit. Replace with 1-watt unit.—*Jim Wilhelm* END

COMING NEXT MONTH... in February

## Radio-Electronics

Whether you're service technician, experimenter, engineer, hi-fi enthusiast, or electronics layman, the February issue is your meat. Just look:

### C-D SCR IGNITION FOR \$25—Cover Story COMPONENTS SECTION

Fills you in on phono cartridges, circuit breakers, tuning indicators, checking voltages without vtvm or vom, stepping switches, power resistors, selecting batteries.

### FUEL CELLS

Power for electric cars and space capsules

### TEST EQUIPMENT TO BUILD

Transistor characteristics tester you can use to identify unknown transistors and find how to use them in experiments, for replacements.

### COMPUTERS AT SEA

Digital systems for underseas exploration

NO MATTER WHO YOU ARE, YOU'LL FIND A MAGAZINE-LOAD OF SERVICING AND BUILDING INFORMATION, PLUS THE LATEST ELECTRONIC DEVELOPMENTS in

**FEBRUARY Radio-Electronics**

Get it at your newsstand on January 24.

**BIGGER... BETTER  
THAN EVER!**

**FREE!**



SEND TODAY FOR YOUR NEW  
**40th ANNIVERSARY  
1967 CATALOG**



### YOUR BUYING GUIDE FOR

- Stereo & Hi-Fi Systems & Components.
- Tape Recorders.
- Electronic Parts, Tubes, Tools.
- Phonos & Records.
- Cameras and Film.
- Public Address.
- Citizens Band. ● Ham Gear.
- Transistor & FM-AM Radios.

**252 GIANT VALUE  
PACKED PAGES!**

**BURSTEIN-APPLEBEE CO.**

Dept. RE, 1012 McGee, Kansas City, Mo. 64106  
 Rush me the FREE 1967 B-A Catalog.

Name.....  
Address.....  
City.....  
State..... Zip Code.....

Circle 133 on reader's service card



## U.S. GOV'T ELECTRONIC SURPLUS

• Nationally Known-World Famous SURPLUS CENTER offers finest, most expensive, Government Surplus electronic units and components at a fraction of their original acquisition cost.

ORDER DIRECT FROM AD OR WRITE FOR CATALOGS

### LABORATORY EXPERIMENTAL KIT

PERFORM 100'S OF FASCINATING ELECTRICAL EXPERIMENTS

Gov't Acquisition Cost Of Parts Over \$50.00

**\$14.85**  
F.O.B.



• (ITEM #A222) -- Amazing Value! Valuable gift for son or husband. Hundreds of fascinating experiments. Teaches modern electronic theory and practice. Easy, interesting way to learn.

• Experiment with electro-plating, electro-magnetic phenomena, resonance, burglar alarm, relay circuits, rectification, test circuits, eavesdropping, motor experiments, transformer phenomena, etc.

• Kit Contains: DC motor, AC motor, electro-magnetic coils, ac and dc relays, set of lab capacitors, compass, test bulbs, plating chemicals, silicon diodes, germanium diode, burglar alarm actuator, carbon microphone eavesdropping element, ac test sockets, permanent magnets, telephone handset, cords, test clips, wire, and other items. Over 35 pieces. Includes fine Experimental Manual with drawings, procedures, etc., written by professional engineers.

• Also furnished with each kit our popular book Home Laboratory Bench and Experimental Procedures, (Reg. \$1.00). Shows how to build wonderful home laboratory test bench, and how to get the most out of your experimental work. (12 lbs.) Parts cost gov't over \$10.00.

### AC PROGRAM TIMING CLOCK

• (ITEM #158) -- Zenith 115-VAC program timer. Use for periodic signaling, work breaks, school classes, turn on radio for newscasts, etc. Adjustable clips permit switching on or off anytime during 24-hour period. Sufficient clips for multiple programming. Also has "skip-a-day" feature. Contacts can handle up to 15 amps. 8 1/2" x 6 1/2" x 4". Wt. 8 lbs. Gov't Cost Over \$30.00.

Instructions Furnished. F.O.B. **\$9.49**



### AUTO-PILOT GYROSCOPE



F.O.B. **\$12.47**

• (ITEM #115) -- DC motor driven, gimbal mounted gyroscope. Ultra-expensive precision unit used to "steer" large multi-engine planes. Deviation from established plane sends potentiometer controlled signals to bring about change in other motors. Unit can be used as auto-pilot for boats. Wonderful class room unit to demonstrate and study gyro action. Missiles, planes, boats all use gyros. Size 9" x 8" x 10". Wt. 21 lbs. Cost Gov't Over \$500.00.

### STANDARD DIAL TELEPHONE

• (ITEM #715) -- Standard, commercial telephone same as used throughout U.S.A. Attractive polished black, like new condition. Use as extension phone to private systems or connect several phones together for local intercom system. Full instructions are furnished. Wt. 9 lbs. Original Cost \$24.50.

F.O.B. **\$5.95**



### STEP-BY-STEP AUTOMATIC SWITCH

• (ITEM #738) -- Amazing "up-and-around" electro-magnetic telephone switch. Dial any bank pair from 1 to 100. Make your own telephone system. Can also be used to remotely control up to 100 circuits over a single pair of wires.

• One of our FOUR STAR bargains. Comes complete with data, one dial and one line bank. Size, 5 1/2" x 7 1/2" x 15". Wt. 16 lbs. Cost Gov't Over \$75.00. Complete switch, cover, dial, line bank, instructions..... F.O.B. **\$9.95**



### STEP UP/DOWN TRANSFORMER

• (ITEM #1543) -- Step voltage up or down. Has many uses. Will step 115-volts up to 230-volts or step 230-volts down to 115-volts. Will also transform 115-volts to 55-volts. Rated 1.75 amps, output with 175-watt capacity. Size... 4 1/2" x 3 1/2" x 2". Wt. 4 lbs. Gov't Cost \$12.75.

F.O.B. **\$4.99**

### TYPICAL BUYS FROM OUR 1967 CATALOGS

- \$ 350.00 - Geared 2-hp Battery Golf Car Motor ..... **\$24.95**
- \$ 15.00 - Westinghouse DC Ammeter, 0 to 300 ..... **\$ 7.11**
- \$ 40.00 - Vacuum/Pressure Pump, 12-VDC ..... **\$11.95**
- - - -80-MW Walkie-Talkies, Per Pair ..... **\$19.60**
- - - -Deluxe, Multi-Range, AC/DC Tester ..... **\$ 8.98**
- \$400.00 - Darier Telephone Amplifier System ..... **\$13.91**

### SPECIAL SALE

Correspondence Course In ELECTRICAL ENGINEERING



Sells For \$10.79 Outside U.S.A. **\$8.79** Postpaid In U.S.A.

• (ITEM #A181) -- Wonderful chance to obtain technical training at Amazing Low Cost! Lincoln Engineering School has suspended its Correspondence Courses because of increased operating costs. We offer a limited number of the school's complete Electrical Engineering Course but without the examination paper grading service. The course consists of 14 lesson unit books. Each book has the regular exams, and in a separate section, "Standard Answers" to each exam question.

• Course is well written, easy to understand, profusely illustrated. Reader's Digest size, easy to carry and study in spare time. Many Lincoln Engineering School students holding excellent jobs as a result of L.E.S. training. Course contains latest information on transistors, silicon diodes, etc. Additional book on how to build and operate a "Home Laboratory and Experimental Bench" furnished with each course.

SEND 25c COIN OR STAMPS FOR 3 MAIN CATALOGS

All Items FOB Lincoln Money Back Guarantee

**SURPLUS CENTER**

DEPT. RE-017 LINCOLN, NEBR. 68501

# TRY THIS ONE

## SOLDERING-IRON KINK

For years, I've tinned the tips of new soldering irons with silver solder. This greatly increases the life of the tip since silver solder does not erode as rapidly as copper. Silver solder is now readily available at plumbing supply houses and most hardware stores. It is easily applied using a small butane or propane torch.—O. K. Hudson

## PEAK VOLTAGE WITH SCOPE AND DIODE

To measure the peak voltage of a complex waveform, feed the signal to the scope input through the highest series resistor you can use without affecting its shape, and shunt across it a reverse-biased diode having high back resistance and sufficient piv rating. Reduce the bias until you see the peak barely get clipped a little. The bias is then equal to the peak voltage. You can measure ei-

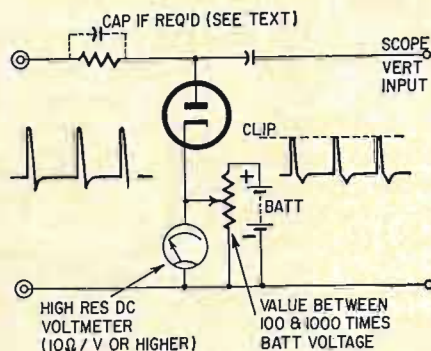

ther the positive or the negative peak by turning the diode, the bias source and the voltmeter around, and you can measure with respect to any point in the circuit by returning the low side of the bias to that point. An expensive scope with special features is not necessary and you don't even need to know where the centerline is.

I found I could reset to 0.1 volt using an ordinary receiving-tube diode.

At high frequencies you can shunt the resistor with a small capacitor if necessary to preserve wave shape.

—A. H. Taylor

END

## Radio-Electronics Is Your Magazine!

Tell us what you want to see in it. Your suggestions may make it a better magazine for the rest of the readers as well as yourself. Write to the Editor, RADIO ELECTRONICS, 154 West 14th St., New York, N. Y. 10011.

98

# a Must!! for Color T.V. Service

## TEST ADAPTER TA 1-00

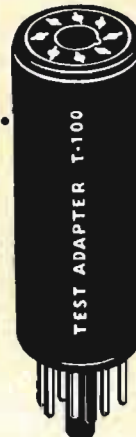

- Adapts Admiral Color T.V. chassis to R.C.A. type test jig.
- Don't burn out your present test jig.
- Don't send two men to pick up whole set.
- Save the cost of another test jig.
- More than pays for itself on first repair.
- Serviceman's net, \$4.95.
- Available at your local parts jobber or send \$4.95.

TO:

**Electro-Tek, Inc.**

301 Branch Ave., Prov., R.I. 02904

Circle 123 on reader's service card

Enjoy the "music-only" programs now available on the FM broadcast band from coast to coast.

- NO COMMERCIALS •
- NO INTERRUPTIONS •



It's easy! Just plug Music Associated's Sub Carrier Detector into multiplex jack of your FM tuner or easily wire into discriminator. Tune through your FM dial and hear programs of continuous commercial-free music you are now missing. The Detector, self-powered and with electronic mute for quieting between selections, permits reception of popular background music programs no longer sent by wire but transmitted as hidden programs on the FM broadcast band from coast to coast. Use with any FM tuner. Size: 5 1/2" x 9". Shipping weight approx. 7 lbs.

**KIT \$49.50**

(with pre-tuned coils, no alignment necessary)

**WIRED \$75.00** (Covers extra \$4.95 ea.)

Current list of FM Broadcast stations with SCA authorization \$1.00

**MUSIC ASSOCIATED**

65 Glenwood Road, Upper Montclair, N. J. Phone: (201)-744-3387 07043

Circle 124 on reader's service card

Circle 134 on reader's service card



# WHAT'S YOUR EQ?

These are the answers.  
Puzzles are on page 61.

## Resistor Network

The total resistance is  $\frac{2}{3}$  ohm. Yes, all resistors are in parallel!

## Light Switching Circuit

The reverse resistance of the diodes (any receiving-type silicons) blocks current flow to both lamps when both switches are open. When S1 is closed, current flows through D3, L1,

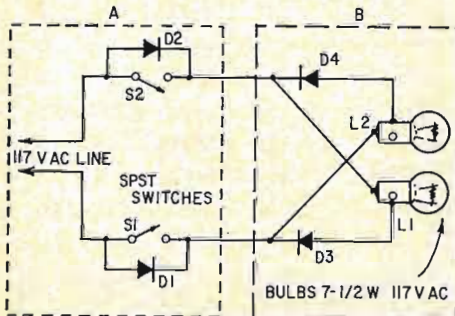

D2, lighting L1. But current cannot flow through L2 because D2 and D4 are back to back in series with L2, blocking current flow on both half-cycles of the ac. END

## 50 Years Ago

In *Gernsback Publications*  
From January, 1917  
*Electrical Experimenter*

The Radio Obliterator  
The Presidential Amateur Radio Relay  
New Wireless Law Planned  
Election Returns Flashed by Radio to 7,000 Amateurs  
New Audion and Radiophone Apparatus  
Long Distance Radio Without Aerials  
Radio Detector Development, by H. Winfield Secor  
Action of Detectors in Wireless Telegraphy, by Wilder D. Bancroft  
Marconi Company Sues the U.S. for \$1,000,000 Damages, by A. Press, B. Sc.



**EFFICIENT!  
SAFE!  
FAST!**



## AUTOMATIC STAPLE GUNS

For Fastening Any Inside or Outside

Wire Up to 1/2" in Diameter

- UP TO 3/16"  
**No. T-18**
- UP TO 1/4"  
**No. T-25**
- UP TO 1/2"  
**No. T-75**

- Telephone wire
  - Intercom wire
  - Bell wire
  - Thermostat wire
  - Radiant heating wire
  - Hi-Fi, Radio & TV wires
- Tapered striking edge gets into close corners!

Available in:  
Brown, Ivory, Beige,  
Monel, Bronze, Natural

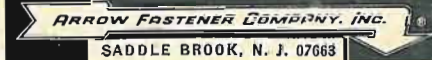

Circle 136 on reader's service card

## FINCO-AXIAL COLOR-KIT

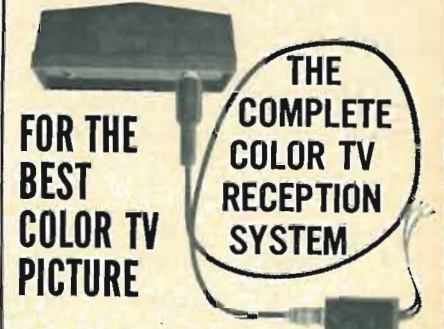

FOR THE BEST COLOR TV PICTURE

THE COMPLETE COLOR TV RECEPTION SYSTEM

VHF • UHF • FM • PASSES AC & DC eliminates color-fade, ghosting and smearing! Improves FM and Stereo, too!

FINCO-AXIAL COLOR-KIT, Model 7512 AB  
High performance Indoor and Outdoor Matching Transformers convert old-fashioned and inefficient 300 ohm hook-ups to the new Finco-Axial 75 ohm color reception system. List price for complete kit 7512 AB . . . . . \$8.95  
7512-A Mast mounted matching transformer, list \$5.40  
7512-B TV set mounted matching transformer list \$4.15

FINCO-AXIAL SHIELDED COLOR CABLE, CX Series  
Highest quality, 75 ohm swept co-axial cable (RG 59/U) complete with Type F fittings and weather boot ready for installation.

Available in 25, 50, 75 and 100 foot lengths.  
List price . . . \$5.55, \$8.65, \$11.50 and \$14.20

Write for Color Brochure Number 20-349

**THE FINNEY COMPANY**  
34 West Interstate St., Dept. RE Bedford, Ohio.

Circle 137 on reader's service card

# ELECTRONICS



## Engineering-Technicians

**Bachelor of Science Degree, 30 Months**  
Save Two Years' Time

- Radio-Television Plus Color Technician (12 Months)
- Electronics Engineering Technology (15 Months)
- Electronics Engineering (B.S. Degree)
  - Electrical Engineering (B.S. Degree)
  - Mechanical Engineering (B.S. Degree)
  - Civil Engineering (B.S. Degree)
  - Architecture (B.S. Degree) (36 Months)

The Nation's increased demand for Engineers, Electronic Technicians, Radio TV Technicians is at an all time high. Heald Graduates are in demand for Preferred High Paying Salaries. Train now for a lucrative satisfying lifetime career.

Approved for Veterans

DAY AND EVENING CLASSES

## HEALD ENGINEERING COLLEGE

1215 Van Ness Avenue  
San Francisco, California

Write for Catalog and Registration Application.  
New Term Starting Soon.

Your Name .....

Address .....

City .....

State .....

Circle 125 on reader's service card



# COLOR-TV TUBE POPULARITY GUIDE

This compilation lists how often various tube types are used in leading 1964-1966 color TV chassis sold under nearly fifty brand names.

The 6GH8 is front-runner with 381. Some chassis use only one of them; others use up to six. Other leaders are 3A3 high-voltage rectifiers, 6BK4 high-voltage

regulators, 6DW4 dampers and 6GU7's and 6GY6's in color demodulator and amplifier circuits.

Tube types—not necessarily new—appearing in 1966 chassis are shown in heavy type. Watch for these and make sure you have an adequate supply in stock and in your tube caddy.

Tube type	No. of tubes	Tube type	No. of tubes	Tube type	No. of tubes	Tube type	No. of tubes	Tube type	No. of tubes
1AD2	2	3A3-A	250	4EH7	10	5MB8	3	6AU6-A	55
1AU2	2	3AT2	38	4EJ7	10	6AC10	3	6AU8-A	3
1DK27	1	3AW3	4	4GX5	1	6AD10	10	6AV6	1
1K3	2	3BZ6	2	4HA5	1	6AF4-B	1	6AW8-A	83
1V2	36	3CA3	2	4LJ8	1	6AF9	5	6AY3	2
2AF4-B	1	3DT6	1	5AQ5	1	6AH5	1	6BA6	2
2AV2	44	3HQ5	3	5CG8	1	6AL5	11	6BA11	18
2BA2	4	4AU6	1	5GM6	2	6AL11	1	6BC6	1
2DZ4	1	4BL8	4	5GX7	3	6AQ5-A	109	6BH11	4
2GK5	2	4BZ6	2	5JK6	4	6AQ8	3	6BJ8	2
2HQ5	1	4CB6	10	5KZ8	1	6AU4-GTA	1	6BK4-A, -B	262
								6BL8	46
								6BM8	7
								6BN6	5
								6BN8	14
								6BN11	9
								6BQ5	10
								6BS3	2
								6BX6	4
								6BZ6	30
								6C4	1
								6CB6	3
								6CD3	7
								6CE3	7
								6CG3	11
								6CG8-A	15
								6CJ5	3
								6CL8-A	4
								6CS6	11
								6CW5	5
								6DK6	5
								6DQ5	1
								6DQ6	6
								6DS4	51
								6DT6-A	27
								6DW4-A, -B	268
								6DX4	1
								6DZ4	2
								6EA4	1
								6EA8	39
								6EB8	2
								6EH7	56
								6EJ6	1
								6EJ7	151
								6EM7	1
								6EW6	187
								6EW7	4
								6EZ5	4
								6FG7	9
								6FM7	1
								6FQ7/6CG7	165
								6GB5	2
								6GC5	2
								6GF7-A	109

## 48<sup>th</sup> ANNIVERSARY SALE AND OUR 20TH YEAR OF STEADY ADVERTISING IN RADIO-ELECTRONICS WITHOUT MISSING A SINGLE ISSUE — A WORTHY GUARANTEE OF VALUE & RELIABILITY—

FREE \$1 BUY WITH EVERY 10 YOU ORDER

Only applies to "\$1" Buys

FREE GIFT WITH EVERY ORDER

- 6—ELECTROLYTIC CONDENSERS 10/10-450v, 80-200v, 50-60v .. \$1
- 6—ELECTROLYTIC CONDENSERS 20/10mfd - 350v, 80mfd - 50v .. \$1
- B—ASST LUCITE CABINETS hinge cover, handy for parts .. \$1
- 100—MIXED DEAL "JACKPOT" Condensers, Resistors, Surprises .. \$1
- 1—SQ. YARD GRILLE CLOTH most popular brown & gold design .. \$1
- 20—EXPERIMENTER'S COIL "JACKPOT" assorted for 101 uses .. \$1
- 20—ASST. PILOT LIGHTS #44, 46, 47, 51, etc. .... \$1
- 50—ASST. DISC CERAMIC CONDENSERS popular numbers .. \$1
- 10—ASST. RADIO ELECTROLYTIC CONDENSERS .. \$1
- 50—ASST. TUBULAR CONDENSERS .001 to .47 to 600v .. \$1
- 20—STANDARD TUBULAR CONDENSERS .047-600v .. \$1
- 3-1/2 MEG VOLUME CONTROLS with switch, 3" shaft .. \$1
- CLEAN UP THE KITCHEN" JACKPOT" Big Deal only one to a customer .. \$1
- 5—ASSORTED TRANSFORMERS Radio, TV and Industrial .. \$1
- 2—G.E. 6X5GT TUBES brand new, individually boxed .. \$1
- BONANZA "JACKPOT" not gold, not oil, but a wealth of Electronic Items—Money-Back-guarantee .. \$5
- 75'—MINIATURE ZIP CORD 2 conductor, serves 101 uses .. \$1
- 10—ASSORTED SLIDE SWITCHES SPST, SPDT, DPDT, etc. .... \$1
- 10 SETS — DELUXE PLUGS & JACKS asst. for many purposes .. \$1
- 10 — SETS PHONO PLUGS & PIN JACKS RCA type .. \$1
- 10 — SURE-GRIP ALLIGATOR CLIPS 2" plated .. \$1
- 50—RADIO & TV SOCKETS all type 7 pin, 8 pin, 9 pin, etc. .. \$1
- 200'—BUSS WIRE #20 tinned for hookups, special circuits, etc. .. \$1
- 100—STRIPS ASSORTED SPAGHETTI handy sizes .. \$1
- 100—ASSORTED RUBBER GROMMETS best sizes .. \$1
- 50—ASSORTED PRINTED CIRCUIT SOCKETS best types .. \$1
- 20—ASSORTED VOLUME CONTROLS less switch .. \$1
- 7—ASSORTED VOLUME CONTROLS with switch .. \$1
- 5 — ASST. SELENIUM RECTIFIERS 65ma, 100ma, 300ma, etc. .. \$1

**RCA 110° FLYBACK TRANSFORMER**



We scooped the Market Latest type — standard for all 110° TV's  
RCA's design of large Coil produces 18KV—assuring adequate width  
Incl Schematic Diagram application for any TV  
List price \$13.90  
Your price .. \$3  
10% off in lots of 3

110° TV DEFLECTION YOKE for all type TV's incl schematic same as Thordarson Y502 list \$20 \$3

COMBINATION SPECIAL — RCA 110° FLYBACK PLUS 110° DEFLECTION YOKE .. \$5

90° FLYBACK TRANSFORMER for all type TV's incl schematic \$2

90° TV DEFLECTION YOKE for all type TV's incl schematic .. \$2

70° FLYBACK TRANSFORMER for all type TV's incl schematic \$1

70° TV DEFLECTION YOKE for all type TV's incl schematic \$1

2F—ASSORTED TV COILS I.F. video, sound, ratio, etc. .... \$1

40—ASSORTED TV KNOBS all standard types, \$20 value .. \$1

50 — ELECTROLYTIC CONDENSERS 25mfd-6v, top quality .. \$1

25 — BENDIX CONDENSERS 007-2000v \$15 value .. \$1

10 — G.E. SAPPHIRE NEEDLES 4G, VR-11, etc. (\$25.00 value) .. \$1

15 — G.E. #NE-2 TUBES Neon Glow Lamp for 101 uses .. \$1

2—G.E. PIECES OF EQUIPMENT stacked with over 200 useful parts .. \$1

10—ASSORTED DIODE CRYSTALS 1N34, 1N48, 1N60, 1N64, 1N82 .. \$1

10—STANDARD TRANSISTORS NPN & PNP 2N404, 2N414, etc. .. \$1

5 — TOP HAT SILICON RECTIFIERS 500ma-600v top quality .. \$1

1 — LB SPOOL ROSIN-CORE SOLDER 40/60 top quality .. \$1

3 — ELECTROLYTIC CONDENSERS popular number—50/30 150v .. \$1

7 — ASST. TV ELECTROLYTIC CONDENSERS popular selection .. \$1

\$15.00 TELEVISION PARTS "JACKPOT" best buy ever .. \$1

IMMEDIATE DELIVERY . . . Scientific light packing for safe delivery at minimum cost.  
HANDY WAY TO ORDER: Pencil mark or write amounts wanted in each box, place letter F in box for Free \$1 BUY. Enclose with check or money order, add extra for shipping. Tearsheets will be returned as packing slips in your order, plus lists of new offers.

Name .....

Address .....

Cost of goods .....

Shipping .....

estimated .....

TOTAL .....

Please specify refund on shipping overpayment desired:  CHECK  POSTAGE STAMPS  MERCHANDISE (our choice) with advantage to customer

Circle 138 on reader's service card



Tube type	No. of tubes	Tube type	No. of tubes	Tube type	No. of tubes	Tube type	No. of tubes
6GH8-A	381	6JH8	35	6Y9	9	12BH7	2
6GJ7	27	6JM6	14	6Y10	4	12BV11	2
6GK5	10	6JS6-A	41	6Z10	3	12BY7-A	86
6GK6	12	6JT8	14	7GS7	1	12GC6	2
6GM6	130	6JU8-A	119	7GV7	1	12GE5	2
6GU7	200	6JW8	10	8AC9	1	12GN7	41
6GW8	2	6KA8	76	8AR11	2	12HG7	41
6GX6	2	6KD6	7	8AW8	2	12HL7	3
6GX7	21	6KE8	4	8BQ11	2	12MD8	2
6GY6	225	6KM6	2	8BU11	2	12R-LL5	2
6HA5	45	6KN6	4	8FQ7	19	12T10	2
6HB6	10	6KT8	56	8JV8	11	15CW5	2
6HB7	40	6KZ8	27	9AQ8	3	15DQ8	3
6HE5	19	6LE8	11	9KC6	10	15HB6	1
6HF5	6	6LF8	20	9R-HR2	2	15LE8	1
6HL8	2	6LJ8	10	10CW5	1	16A8	2
6HM5	6	6LM8	20	10JT8	4	19AU4-GTA	3
6HQ5	55	6LN8	2	10LB8	1	21LR8	14
6HQ7	4	6LT8	1	10LE8	10	30AE3	1
6HS5	9	6LU8	25	11BT11	2	31JS6-A	10
6HS8	21	6M11	1	11FY7	2	34CD3	13
6HZ6	103	6MD8	5	11LQ8	10	34CE3	13
6J10	12	6ME8	6	12AV6	10	42KN6	3
6JC6	55	6MG8	2	12AX3	2	50C5	10
6JD6	6	6R-P22	12	12AX7	16	5642	7
6JE6-A	74	6U10	10	12AZ7	8	PL-521	1
6JH6	87	6X9	9	12BF11	2	END	

# Why Do You Read So Slowly?

A noted publisher in Chicago reports there is a simple technique of rapid reading which should enable you to double your reading speed and yet retain much more. Most people do not realize how much they could increase their pleasure, success and income by reading faster and more accurately.

According to the publisher, anyone, regardless of his present reading skill, can use this simple technique to improve his reading ability to a remarkable degree. Whether reading stories, books, technical matter, it becomes possible to read sentences at a glance and entire pages in seconds with this method.

To acquaint the readers of this publication with the easy-to-follow rules for developing rapid reading skill, the company has printed full details of its interesting self-training methods in a new booklet, "How to Read Faster and Retain More" mailed free to anyone who requests it. No obligation. Send your name, address, and zip code to: Reading, 835 Diversey Parkway, Dept. 684-011, Chicago, Ill. 60614. A postcard will do.

Circle 134 on reader's service card

CANADIANS: Ordering is easy . . . we do the paperwork . . . try a small order

## SARKES TARZIAN TV TUNER 41mc

Latest Compact Model—good for all 41 mc TV's.  
BRAND NEW—MONEY BACK GUARANTEE

Best TUNER "SARKES TARZIAN" ever made—last word for stability, definition & smoothness of operation. An opportunity—to improve and bring your TV Receiver up-to-date.

COMPLETE with Tubes & Schematic . . . \$7.95



## HIGHWAVE AM-FM PORTABLE RADIO

Elegance in Ebony & Chrome  
14 Transistors - A Powerhouse of Quality Reception with AFC Operates on 4 "C" Cells  
22" Telescoping FM Antenna & Personal Listening attachment  
Money refund - if not better than any Known Brand selling for even twice the price  
8" x 5 1/4" x 2 1/4" - 4 lbs



COMPLETE . . . \$19.50

## IBM COMPUTER SECTIONS

8 assorted Units we sell for \$1 are loaded with over 150 valuable parts.

Incl. — Transistors, Condensers, Resistors, Heat Sinks, Diodes, Etc.

8 for \$1  
100 for \$10



## 12 HARDWARE GOODIES

- 1000—ASST. HARDWARE KIT \$1  
screws, nuts, washers, rivets, etc.
- 300 — ASSORTED HEX NUTS \$1  
2/66, 4/40, 5/40, 6/32, 8/32 . . .
- 250—ASST. SOLDERING LUGS \$1  
best types and sizes . . . . .
- 250—ASST. WOOD SCREWS \$1  
finest popular selection . . . . .
- 250 — ASST. SELF TAPPING SCREWS \$1  
#8, #8, etc. . . . .
- 150—ASST. 6/32 SCREWS and 150 6/32 HEX NUTS \$1
- 150—ASST. 8/32 SCREWS and 150—8/32 HEX NUTS \$1
- 150—ASST. 2/56 SCREWS and 150—2/56 HEX NUTS \$1
- 150—ASST. 4/40 SCREWS and 150—4/40 HEX NUTS \$1
- 150—ASST. 5/40 SCREWS and 150—5/40 HEX NUTS \$1
- 500—ASSORTED RIVETS \$1  
most useful selected sizes . . . . .
- 500—ASSORTED WASHERS \$1  
most useful selected sizes . . . . .

- HEARING AID AMPLIFIER \$2  
incl. 3 Tubes, Mike, etc. (as is)
- UNIV. 3" x 5" PM SPEAKER \$7.50  
Best type for Radios, TV, Etc. . .
- UNIVERSAL 4" PM SPEAKER \$6.95  
Alnico 5 magnet, quality tone . . .
- 10 — SPEAKER PLUG SETS \$1  
deluxe type, 2 conductor . . . . .
- CHAPT ZU DI MITZIA "JACK-POT" \$1  
(double your money back if not completely satisfied . . . . .)
- 300 — ASST. 1/2 W RESISTORS \$1  
Top Brand, Short leads, excellent
- 100 — ASST. RUBBER & FELT FEET FOR CABINETS \$1  
best sizes
- 5 — I.F. COIL TRANSFORMERS \$1  
sub-min for Transistor Radios . . .
- 5 — AUDIO OUTPUT TRANSFORM \$1  
Sub-min for Trans Radios
- 4 — TOGGLE SWITCHES \$1  
SPST, SPDT, DPST, DPDT . . . . .
- 15 — ASST. ROTARY SWITCHES \$1  
all popular types \$20 value . . . . .
- 70—BRASS FAHNESTOCK CLIPS \$1  
popular type & size, plated . . . . .
- 32—TEST PROD WIRE \$1  
deluxe quality, red or black . . . . .

- 100 — ASST. MICA CONDENSERS \$1  
some in 5% . . . . .
- 100—ASST 1/4 WATT RESISTORS \$1  
stand. choice ohmages, some in 5%
- 100 — ASST 1/2 WATT RESISTORS \$1  
stand. choice ohmages, some in 5%
- 70 — ASST 1 WATT RESISTORS \$1  
stand. choice ohmages, some in 5%
- 35 — ASST 2 WATT RESISTORS \$1  
stand. choice ohmages, some in 5%
- 50 — PRECISION RESISTORS \$1  
asst. list-price \$50 less 98% . . .
- 20 — ASS'TED WIREWOUND RESISTORS, 5, 10, 20 watt \$1
- 50 — ASST. TERMINAL STRIPS \$1  
all types, 1-lug to 6-lug . . . . .
- 25 — INSTRUMENT POINTER KNOBS \$1  
selected popular types . . . . .
- 50 — ASST. RADIO KNOBS \$1  
all selected popular types . . . . .
- 5 — PNP TRANSISTORS \$1  
general purpose, TO-5 case . . . . .
- 5 — NPN TRANSISTORS \$1  
general purpose, TO-5 case . . . . .
- 2 — POWER TRANSISTORS No. 1 \$1  
Replace 2N156, 2N176, 2N301, etc.
- 10 — ASST DUAL CONTROLS \$1  
for Radio, TV, Hi-Fi, Stereo, etc.

- TAPE RECORDER — assorted types \$4  
good, bad, broken, as-is, potluck
- TRANSISTOR RADIO asst type \$1.50  
good, bad, broken, as-is, potluck
- 6 — TRANSISTOR RADIO EAR-PIECES \$1  
wired complete with plug
- 50 — ASSORTED MYLAR CONDENSERS \$1  
popular selected types . . . . .
- TELEPHONE JACK or PLUG \$50  
make any telephone portable
- TELEPHONE RECORDING DEVICE \$1  
instant suction cup fit . . . . .
- CRYSTAL LAPEL MICROPHONE \$1  
high impedance, 200-6000 cps . . .
- 25' — MICROPHONE CABLE \$1  
deluxe, 2 conductor, shielded . . .
- \$15.00 RADIO PARTS "JACK-POT" \$1  
handy assortment . . . . .
- 50—TUBE CARTONS (colored) \$1  
assorted sizes for Popular Tubes . .
- 10 — ASSORTED TUBES \$1  
Radio, Television and Industrial . .
- ALL AMERICAN TUBE KIT \$2  
Top Standard Brand — 12BA6, 12BE6, 12AV6, 50C5, 6X4 . . . . .
- 5 — RCA 1U4 TUBES brand new \$1  
boxed, also serves as a 1T4 . . . . .

BROOKS RADIO & TV CORP., 487 Columbus Ave., New York, N. Y. 10024

TELEPHONE 212-874 5600



# Olson®

**FREE**

Fill in coupon for a **FREE** One Year Subscription to **OLSON ELECTRONICS' Fantastic Value Packed Catalog**—Unheard of **LOW, LOW PRICES** on Brand Name Speakers, Changers, Tubes, Tools, Stereo Amps, Tuners, CB, Hi-Fi's, and thousands of other Electronic Values. Credit plan available.

NAME \_\_\_\_\_  
 ADDRESS \_\_\_\_\_  
 CITY \_\_\_\_\_ STATE \_\_\_\_\_ ZIP \_\_\_\_\_

If you have a friend interested in electronics send his name and address for a **FREE** subscription also.

**OLSON ELECTRONICS, INC.**

551 S. Forge Street Akron, Ohio 44308

Circle 139 on reader's service card

### "TAB" • SILICON ONE-AMP DIODES

Full Leads Factory Tested & Gtd! U.S.A. Mfg

	Piv/Rms 50/35	Piv/Rms 600/420	Piv/Rms 200/140	Piv/Rms 800/560	Piv/Rms 300/210
400/280	.05	.07	.10	.12	.14
1000/700	.21	.30	.40	.50	.60

ALL TESTS AC & DC & FWD & LOAD!

1700Piv/1200Rms @ 750ma \$1.20 @ .10 for \$10  
 2400Piv/1680Rms @ 750ma \$2 @ .6 for \$11

### SILICON POWER DIODES - STUDB & P.F.\*\*

D.C. Amps	50 Piv 35 Rms	100 Piv 70 Rms	200 Piv 140 Rms	300 Piv 210 Rms
3	.10	.15	.22	.33
12	.25	.30	.45	.70
18	.40	.50	.75	1.00
45	.80	1.20	1.40	1.90
160	1.60	2.90	3.40	4.60
240	3.75	6.75	7.75	10.45

240 400 Piv 600 Piv 700 Piv 900 Piv  
 Amps 280 Rms 420 Rms 490 Rms 630 Rms

1700 Piv Silicon Tube Replacement . . . \$2 @ .6 for \$9  
 5R4 Silicon Tube Replacement . . . \$5 @ .2 for \$9  
 866A Silicon Tube Replacement \$14 @ .2 for \$25

### "TAB" ★ SCR'S ★ TRANSISTORS ★ ZENERS!!!

Full Leads Factory Tested & Gtd! U.S.A. Mfg.  
 PNP HiPower/15Amp Round T036 Package.  
 2N441, 442, 277, 278, D5501 \$1.25 @ .5 for \$5  
 2N278, 443, 174 up to 80V/VGBO \$3 @ .2 for \$5  
 3 Amp 20 Watt Transistors c35 @ .4 for \$1.00  
 PNP/2N107, 123, 218, 223, 1191, 1265, 4 for \$1  
 GT222, TR722 & CK722 c25 @ .4 for \$1  
 NPN/2N55, 94, 194, 213, 214, 216, 228, 233, 4 for \$1  
 292, 293, 306, 516, 517, 1101 c39 @ .4 for \$1  
 PNP/2N670/300MW c45 @ .3 for \$1, 25 for \$6  
 PNP/2N671/1 Watt c75 @ .4 for \$2, 10 for \$4  
 2N1039/1 Watt c30 @ .4 for \$2, 10 for \$4  
 Silicon PNP/T05 & T018 Pkg 2N327A, 332 to 8, 2N474 to 9, \$41 to 3, 935 to 7, 1276 to 9, c35 @ .7 for \$2  
 15 Amp Transistor Untested . . . . . 3 for \$1  
 3 Amp Transistor Untested . . . . . 6 for \$1  
 Signal Transistors Asstd. Untested . . . . . 20 for \$1  
 Top Hat Diodes Asstd. Untested . . . . . 25 for \$1  
 Zeners Asstd. Untested . . . . . 4 for \$1  
 Kit Glass Diodes Equip 1N34A . . . . . 20 for \$1  
 Round T036 Diamond T03 Mica Mtg Kits . . . . . 4 for \$1  
 Diode Hdwr, Lug & Mica Mtg Kits . . . . . 3 for \$1  
 Power Heat Sink Finned 100 Sq" \$1.25 @ .5 for \$5  
 Power Heat Sink Fins 350 Sq" \$5 @ .5 for \$15  
 Anodized Ins Kit Square Pwr . . . . . 6 for \$1  
 STABISTOR Diodes Fwd Regulators, 1 watt, 5 for \$1  
 Zener Diodes up to 1W 6 to 200V, 270 @ .25 for \$2  
 Zener Diodes Ten Watt 6 to 150V \$1.45 @ .4 for \$5

511 Micro 18A up to 100 Piv . . . . . 4 for \$1  
 Pico or MUSwitch CSD 35 Amp/AC-DC 3 for \$1

**"TAB"** TERMS: Money Back Guaranteed! Our 22nd Year. \$5 Min. Order F.O.B. N.Y.C. Add ship charges or for C.O.D. 25% Dep. Prices shown subject to change.  
 111-GP Liberty St., N. Y. 6, N. Y.  
 SEND 25¢ Phone: Rector 2-6245 for CATALOG

Circle 140 on reader's service card

# NOTEWORTHY CIRCUITS

## COLOR TUNING INDICATOR

Some of the poor color pictures seen on home and showroom TV sets can be traced to improper tuning. Several manufacturers have become aware of the problem and have added color tuning aids. Philco is using an electron-ray type tuning-indicator tube in several of its top-of-the-line chassis. The diagram shows the basic circuit in the 17MT80B hybrid chassis.

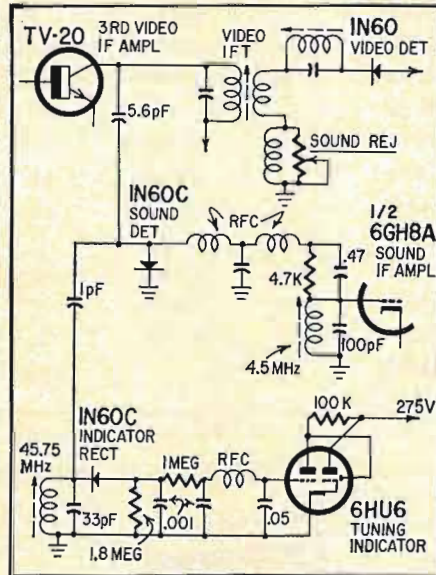

The tuning indicator responds to video carrier level and shows when the fine-tuning control is adjusted for maximum video carrier. Maximum video-carrier level produces the best black-and-white and color picture with proper sound level.

A separate 45.75-MHz detector is used for the indicator. The signal is tapped off the output of the last video i.f. amplifier at the sound takeoff point and coupled to a 45.75-MHz tank through a 1-pF capacitor. This signal is rectified and filtered to develop a negative dc voltage on the grid of the indicator tube. The amplitude of this dc voltage is maximum when the set is tuned for best color. The set is tuned correctly when "eye" closure is maximum.

## UNUSUAL CAPACITANCE RELAY

Most capacitance relays or capacitance-operated switches are based on an oscillator whose frequency or loading is changed when a person or reasonably large metallic object approaches the

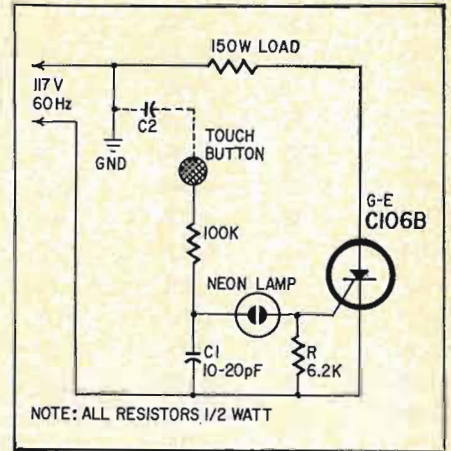

NOTE: ALL RESISTORS, 1/2 WATT

oscillator coil or an antenna or "touch button". Here is a circuit, courtesy of General Electric, that uses a capacitive voltage divider and an SCR.

Capacitor C1 and body capacitance (C2) of the operator form the voltage divider from the hot side of the ac line to ground. The voltage across C1 is determined by the ratio of C1 to C2. The higher voltage is developed across the smaller capacitor. When no one is close to the touch button, C2 is smaller than C1 and the major portion of the line voltage appears across C1. This voltage fires the neon lamp, C1 and C2 discharge through the SCR gate, causing it to trigger and pass current through the load. The sensitivity of the circuit depends on the area of the touch plate. When area is large enough, the circuit responds to proximity of an object rather than to touch. C1 may be made variable so sensitivity can be adjusted. END





# NEW BOOKS

**THE RADIO AMATEUR'S HANDBOOK.** *American Radio Relay League, Newington, Conn. 6 1/2 x 9 1/2 in., 704 pp. Paper, \$4, cloth \$6.50*

The radio amateur's "bible," this popular book gets larger every year. With a 14-page index, you can find data on almost any imaginable phase of radio transmitting and receiving. Basic theory, advanced techniques, construction practices, legal aspects. Almost no ham is ever without it. Technicians like it, too.

**UNITED STATES GOVERNMENT ORGANIZATION MANUAL '66-67.** *General Services Administration, Washington, D. C. 20408. 6 x 9 in., 812 pp. Paper, \$2.00*

Describes services rendered by various bureaus of the government as well as describing their entire organizational structure. Includes all branches and departments and tells who is in charge of each.

**ELECTRIC MOTOR TEST AND REPAIR,** by Jack Beater. *Tab Books, Drawer D, 18 Frederick Rd., Thurmont, Maryland 21788. 5 1/2 x 8 1/2 in., 160 pp. Paper, \$6.95*

For the service shop that also services electrical appliances, here is a comprehensive text on motor testing and winding. Strictly electrical, covers both large and small motors. Dry reading, but very explicit in its instructions.

**ANTENNA ANALYSIS,** by Edward A. Wolff. *John Wiley & Sons, Inc., 605 3 Ave., New York, N. Y. 10016. 6 x 9 in., 520 pp. Cloth, \$25.00.*

Mathematical from beginning to end, the book is devoted entirely to the physics of antennas and transmission lines. Thoroughly indexed, and includes just about every imaginable antenna configuration. Written for graduate engineers in physics.

**ABC'S OF CAPACITORS,** by William F. Mullin. *Howard W. Sams & Co., Inc., 4300 W. 62 St., Indianapolis, Ind. 46206. 5 1/2 x 8 1/2 in., 96 pp. Paper, \$2.25*

Second edition of a popular components manual. Written by a top authority in the field, the information is up-to-date and accurate. Explains construction, operation, applications and testing. Also an excellent chapter on choosing replacements. Written in fairly easy style.

**101 WAYS TO USE YOUR COLOR TV TEST EQUIPMENT,** by Robert G. Middleton. *Howard W. Sams & Co., Inc., 4300 W. 62 St., Indianapolis, Ind. 46206. 5 1/2 x 8 1/2 in., 160 pp. Paper, \$2.95*

Second edition of Middleton's famous "101 Ways" series. This one covers various types of color generators, tells how to trace color signals using the generators and scope, and then breaks color TV into several sections and describes how to use the equipment in each of those sections. Includes over two dozen miscellaneous and unusual uses for the instruments. In step-by-step format, with lots of pattern and waveform photographs.

END

# SCHOOL DIRECTORY



for prestige, high pay, advancement

## Learn TECHNICAL WRITING!

All industries need trained Tech Writers now. Behind every product from a car to a shotgun is a Tech Writer telling you how to use it. Technical Writing is one of the highest paying careers NOT requiring college. The demand for trained writers is growing with thousands needed in all areas.

**ATWS WILL TRAIN YOU AT LOW COST.** Fascinating, easy-to-follow home instruction includes everything you need to become a top-notch highly paid Tech Writer. Send today for free book and sample lesson. No salesman will call. APPROVED FOR VETERANS.

**AMERICAN TECHNICAL WRITING SCHOOLS, Dept. RE-17**  
5512 Hollywood Blvd., Hollywood, Calif. 90028

## for a professional career

Tri-State graduates hold important engineering and business administration posts throughout the U. S. This professionally-oriented small college has outstanding placement record. Four-quarter year permits degree in three years. Excellent faculty. Well-equipped labs. Beautiful 300-acre campus in lake region. Small classes. Modest costs. One-year Drafting-Design Certificate program. Enter March, June, Sept., Jan. For Catalog, write Director Admissions indicating career interest.



**TRI-STATE COLLEGE**  
2417 College Avenue, Angola, Indiana 46703

## Get Your First Class Commercial F. C. C. LICENSE

thru spare-time study by correspondence. Our money-back warranty protects your investment. (Approved for Veterans) Write for Brochure 67. It's free.

**Grantham School of Electronics**  
1505 N. Western Av., Hollywood, Cal. 90027

## LEARN Electronics Engineering AT HOME

Fix TV, design automation systems, learn transistors, complete electronics. College level Home Study courses taught so you can understand them. Earn more in the highly paid electronic industry. Computers, Missiles, theory and practical. Kits furnished. Over 30,000 graduates now employed. Resident classes at our Chicago campus if desired. Founded 1934. Catalog. Vets—write for information about GI Bill Training.

**AMERICAN INSTITUTE OF ENGINEERING AND TECHNOLOGY**  
1139 W. Fullerton Pky., Chicago, Ill. 60614

## \$\$\$ IN ELECTRICAL REPAIR!

Thousands more trained men needed every year in electrical repair. You've seen it yourself. How many times has a trained electrician repaired something in your own home for \$5, \$15, \$35! It is so easy when you know how. One of the fastest trades to learn in spare time. We give you the information to repair anything, washers, clocks, stoves, switches. Do inside and outside wiring, work on new homes. Repair power tools, telephones. Hundreds of fascinating different high paying jobs. We give you all the tools and equipment. It costs you nothing to find out! Send for big 5-piece valuable fact pack. Absolutely free. No obligation.

**ITI Chicago - Los Angeles**  
Write Dept. 65022, 815 E. Rosecrans, Los Angeles 90059.

## GET INTO ELECTRONICS

V.T.I. training leads to success as technicians, field engineers, specialists in communications, guided missiles, computers, radar and automation. Basic & advanced courses in theory & laboratory. Electronic Engineering Technology and Electronic Technology curricula both available. Assoc. degree in 29 mos. B.S. also obtainable. G.I. approved. Graduates in all branches of electronics with major companies. Start Feb., Sept. Dorms, campus. High school graduate or equivalent. Catalog.

**VALPARAISO TECHNICAL INSTITUTE**  
Department C, Valparaiso, Indiana



Learn Electronics for your SPACE-AGE EDUCATION at the center of America's aerospace industry

No matter what your aerospace goal, you can get your training at Northrop Tech, in sunny Southern California.

**COLLEGE OF ENGINEERING.** Get your B.S. degree in engineering in just 36 months by attending classes year round. Most Northrop Tech graduates have a job waiting for them the day they're graduated!

**A & P SCHOOL.** Practical experience on real aircraft. One-year course prepares you for F. A. A. A & P certificate. WRITE TODAY FOR CATALOG.

**NORTHROP INSTITUTE OF TECHNOLOGY**  
1199 W. Arbor Vitae, Inglewood, Calif.

LEARN

# ELECTRONICS

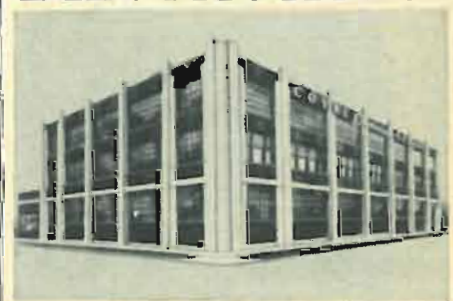

FOUNDED 1899

NOT-FOR-PROFIT

## COYNE ELECTRONICS INSTITUTE

Electronics Engineering Technology—Degree (2 Yrs.)  
Electrical-Electronics Technician—Diploma (40 Wks.)  
TV-Radio-Electronics Technician—Diploma (48 Wks.)  
Master Electronics Technician—Diploma (88 Wks.)  
Practical Electrical Maintenance—Diploma (32 Wks.)  
Practical Refrigeration Air Conditioning and Appliance Repair—Diploma (24 Wks.)  
Introduction to Electrically-Electronics—Certificate (8 Wks.)  
FCC First Class Radiotelephone—Certificate (100 Hrs.)

Special finance plans. Part time employment service while in school. Also Free graduate employment service.



★ VA APPROVED—GI BILL ★

Use this coupon to get our FREE BOOK "YOUR OPPORTUNITIES IN ELECTRONICS"  
**COYNE ELECTRONICS INSTITUTE, Dept. of Electronics 17-N**  
1501 W. Congress Parkway, Chicago, Illinois 60607

Name \_\_\_\_\_ Age \_\_\_\_\_  
Address \_\_\_\_\_ Phone \_\_\_\_\_  
City \_\_\_\_\_ Zone \_\_\_\_\_ State \_\_\_\_\_

Circle 141 on reader's service card



# MARKET CENTER

## GENERAL

CONVERT ANY TELEVISION to sensitive Big-Screen Oscilloscope. Only minor changes required. No electronic experience necessary. Illustrated plans \$2.00. RELCO-A25, Box 10563, Houston 18, Texas

TV SERVICE ORDER BOOKS for use with your rubber stamp. Duplicate or triplicate. Low cost. Write for FREE 32 PAGE CATALOG and Special Rubber Stamp Offer. OELRICH PUBLICATIONS, 6556 W. Higgins, Chicago, Ill. 60656

## HARD-TO-GET TUBES IN STOCK COMPARE OUR PRICES ONE PRICE TO ALL—1 TO 100 BRAND NEW—1 YR. GUARANTEE

Type	Price	Type	Price	Type	Price	Type	Price
200/00A	2.00	6AU8A	1.45	6V6GT	.75	12SL7	1.50
01A	3.00	6AW8A	1.28	6W6GT	.84	12SQ7GT	
0C3	1.92	6AX4	.92	6W6GT	.96	12SR7	1.32
0D3	.82	6AX5	.85	6X4	.96	12SR7	1.79
1A7	2.90	6AX7	1.50	6X5GT	.79	12V6	1.60
1AX2	1.00	6B4	5.95	6X8A	1.10	12W6	1.60
1B3	.98	6B6	3.25	6Y6G	1.55	13GF7	2.08
1H5	3.00	6B8	2.75	6Z4/84	1.25	14A4	1.75
1LA4	2.00	6BA6	.67	7A4	2.75	14A5	1.75
1LA6	2.10	6BA7	1.70	7A4	2.15	14A7	2.00
1LC6	2.00	6BE6	.79	7A6	3.40	14AF7	2.25
1L25	2.00	6BH6	.96	7A7	2.75	14B6	2.00
1L3	2.00	6BH8	1.38	7A8	2.95	14B8	2.00
1LH4	2.75	6BK5	1.47	7AD7	3.00	14C5	2.00
1LNS	2.40	6BK7B	1.19	7AF7	2.75	14C7	2.30
1NS	2.00	6BQ6	1.40	7AG7	2.95	14C8	2.00
1P5	2.25	6BQ7A	1.30	7AH7	1.95	14E7	2.00
1R4	1.95	6BX7	2.39	7AU7	2.85	14F7	2.00
1RS	1.05	6C4	1.60	7B4	2.65	14F8	2.50
1S5	1.05	6C5M	2.30	7B5	3.10	14H7	2.25
1T7	1.25	6C6G	2.75	7B6	1.90	14J7	2.50
1U4	.61	6C6G	2.30	7B7	2.25	14K7	2.25
105	.90	6CA7	2.36	7B8	2.14	14Q7	2.25
1V	3.00	6CC7	.84	7C4	1.15	14W7	2.25
1V2	.86	6CC7	1.15	7C5	1.20	14X7	2.25
1V6	2.80	6CL6	1.61	7C6	2.85	14Y4	2.35
2A3	3.50	6CL8A	1.25	7C7	1.25	19	1.50
2A5	2.95	6CM7	1.96	7E5	3.50	24A	2.00
2A6	4.50	6CQ9	1.15	7E6	3.50	24C	2.00
2021	1.00	6CS7	1.18	7E7	3.50	25C6	.88
2HA5	1.65	6CQ8	1.15	7E8	2.00	25C8	2.45
2X2	.75	6CZ5	1.59	7F8	3.10	25D6	2.50
3A3	1.13	6CZ5	1.77	7G7	2.95	25L6GT	.86
3A5	1.75	6D6	3.10	7H7	3.50	25Z6	1.15
3B7	2.39	6D6	3.10	7J7	3.14	26	1.60
3B8A	1.20	6D6	3.10	7K7	3.14	27	1.75
3B26	.76	6D6	3.10	7M7	2.80	30	1.75
3C86	.84	6D6	3.10	7N7	3.50	32	1.50
3D76	.88	6D6	3.10	7P7	3.50	34	2.00
3Q5	2.20	6E5	2.45	7V7	1.83	35A5	2.44
3V4	.93	6F7	2.38	7Y7	2.98	35B5	2.22
4B7A	1.58	6F5	2.38	7X6	2.98	35W4	.77
4B8A	1.10	6F6G	2.45	7X7	3.00	35Y4	1.95
4Z7	1.56	6F7G	4.95	7Y4	3.00	35Z3	2.03
4C96	.88	6F8G	3.25	7Y7	3.50	35Z5	.65
SAM8	1.35	6GK5	1.32	7Z4	2.55	36	2.25
SAN8	1.35	6J5	1.56	8BQ5	1.20	38	2.50
SAQ5	.83	6J5	1.56	8C7	1.00	39/44	1.80
SA58	1.64	6J5G	1.50	8C7G	1.00	41	2.00
SAT8	1.62	6K7G	2.00	8C8	1.45	43	3.10
SAZ4	2.29	6J7	1.50	8CJ7	1.44	44	3.10
SBQ7B	1.62	6J7GT	1.90	8C8	1.45	43	3.10
SB8B	1.58	6J8C	2.75	8C8	1.45	43	3.10
SC8	1.34	6K6GT	.94	10E7	1.11	46	3.50
SJ6	1.34	6K7M	2.15	12A8	3.25	47	3.95
SU4	.70	6K7GT	1.50	12A8	3.25	48	4.00
SU8	1.10	6K7G	1.95	12AT6	.65	49	4.00
SV4	1.50	6L6G	1.50	12AT7	.88	50	2.00
SV8	1.49	6L6G	1.50	12AU6	.75	50C5	1.70
5Y3GT	.60	6L7M	2.70	12AU7	.84	50L6GT	.70
5Y4	1.42	6N7M	2.00	12AV6	.57	50X6	2.50
5Z3	1.58	6P5	2.50	12AX4	.90	50Y6	1.92
5Z4	3.40	6Q7	2.35	12AX7	.89	50Y7	2.00
6A7	3.45	6S7	2.50	12BA6	.57	53	3.50
6A8	2.79	6S8GT	1.75	12BE5	.61	55	3.25
6B8A	1.00	6SA7M	1.80	12BH7	.96	56	3.25
6B8B	2.75	6SB7Y	2.48	12BQ6	1.35	57	1.75
6AC5GT	2.80	6S97	2.80	12BY7	1.10	58	1.85
6AC7	2.00	6SF5	1.55	12BY7	1.10	59	4.00
6AF3	1.30	6SF7	2.50	12K7GT	2.75	70L7	1.50
6AG7	.96	6SH7	1.98	12K8GT	1.50	71A	1.50
6AG7	2.40	6SH7	1.98	12L6	1.52	75	2.85
6AH4	1.38	6S7GT	1.50	12L6	1.52	75	2.85
6AK5	1.15	6S7M	1.70	12L6	1.52	75	2.85
6AL7	2.98	6SK7	1.80	12Q7GT	1.32	77	2.00
6AMB	1.15	6SK7GT	1.95	12S7GT	.77	78	2.50
6AN8A	1.30	6SK7M	1.80	12S7GT	.77	78	2.50
6AQ7	1.60	6SL7GT	1.30	12SC7	2.00	83	1.75
6ARS	1.00	6SN7GT	.90	12SF7	2.65	83V	2.50
6AS5	.95	6SR7	1.45	12SH7	2.25	5881	3.25
6AS7G	3.95	6SR7	1.40	12SH7	2.25	6146	2.75
6AT6	.74	6SS7	1.95	12S7GT	.60	6336	4.95
6AT8A	1.48	6T9	1.14	12SK7M	1.70	6550	4.00
6AU4	1.15	6T9	1.14	12SK7GT	.80	807	1.25
6AUS	1.68	6U5	3.25	12SK7GT	.80	807	1.25
6AUBA	.73	6UBA	1.10	12SK7GT	.80	807	1.25
						KT88	4.75

OUR MINIMUM ORDER \$5.00  
N. J. Residents—Sales Tax 3%, Postage Extra

Send for complete tube catalog of over 3500 additional types and special purpose tube

## UNITED RADIO COMPANY

56 Ferry St., Newark, N.J.  
P.O. Box 1000 RE-1, Newark, N.J.

Circle 142 on reader's service card

FREE ELECTRONICS (new and surplus) Parts catalog. We repair multimeters. BIGELOW ELECTRONICS, Bluffton, Ohio 45817

PRINTING PRESSES, Type, Supplies. Lists 5¢. TURNBAUGH SERVICE, Mechanicsburg, Pa.

New scientific transistor instrument detects buried coins, treasures. Will detect gold, silver, copper, iron, etc. \$19.95 up. Free catalog. RELCO-A-25, Box 10563, Houston 18, Texas

SOUND MODULE COMPLETE, matchbook size. Resistance-Continuity tester, other uses. \$3.95. Free brochure. VERNIER ELECTROPHYSICAL LABORATORIES, Box 34090, Dallas, Texas 75234

Book "300 TRICKS YOU CAN DO" dollar. Free catalogue. MANDEL, 2912D Neptune Avenue, Brooklyn, New York 11224

## WANTED

QUICK CASH . . . for Electronic EQUIPMENT, COMPONENTS, unused TUBES. Send list now! BARRY, 512 Broadway, New York, N. Y. 10012, 212 WALKER 5-7000

INVENTIONS WANTED. Financial Assistance Free protection forms, information. Contact: INTERNATIONAL INVENTION INSTITUTE, Dept. 29, 160 Broadway, New York, N.Y. 10038

MERCURY, platinum, gold, silver. FREE circular. MERCURY REFINERS, Norwood, Mass.

WANTED: Radar Equipment AN/TPS-10D, APT-9, SCR-584, AN/GPG-1, M-33 etc., P. J. PLISHNER, 550 Fifth Avenue, N. Y. Tele: 212 JU 6-4691



**BLACK/WHITE  
OR  
COLOR**

THE ONLY SAFE NON-DRIFT  
**TV TUNER  
CLEANERS**  
AVAILABLE AT ALL DISTRIBUTORS

**CHEMTRONICS**  
BROOKLYN, N. Y. 11236

## BIG CATALOG

World's "BEST BUYS" in GOV'T. SURPLUS Electronic Equipment

FULL OF TOP QUALITY ITEMS—  
Transmitters, Receivers, Power Supplies, Inverters, Microphones, Filters, Meters, Cable, Keys, Phones, Antennas, Chokes, Dynamotors, Blowers, Switches, Test Equipment, Headsets, Amplifiers, etc., etc. SEND 25¢ (stamps or coin) for CATALOG and receive 50¢ CREDIT on your order. Address Dept. RE.

**FAIR RADIO SALES**  
P.O. Box 1105 · LIMA, OHIO · 45802

# ADVERTISING INDEX

RADIO-ELECTRONICS does not assume responsibility for any errors which may appear in the index below.

Aerovox Corporation (Distributor Div.)	26
Allied Radio Corp.	79, 91-92
Amperex Electronic Corp.	Second Cover
Arrow Fastener Co., Inc.	99
B & K Manufacturing Co., (Div. of Dynascan Corp.)	71
Blonder-Tongue	22
Brach Manufacturing Corp.	84
Brooks Radio & TV Corp.	100-101
Burstein-Applebee Co.	97
Capitol Radio Engineering Institute, The	62-65
Castle TV Tuner Service, Inc.	6
<b>CLASSIFIED</b>	104-107
Cleveland Institute of Electronics	18-21, 84, 88
Columbia Stereo Tape Club	5
Conar (Div. of National Radio Institute)	86
Cornell-Dubilier	27
Cornell Electronics Co.	106
Datak Corporation, The	76
Delta Products, Inc.	70
DeVry Technical Institute	7
Eastman Kodak Company	25
EICO Electronic Instrument Co., Inc.	Third Cover
Electro-Tek, Inc.	98
Electro-Voice, Inc.	66
Electronic Measurement Corp. (EMC)	95
Erie Technological Products, Inc.	72
Finney Co.	76, 99
Gernsback Library Inc.	78, 90
Heald Engineering College	99
Heath Company	74-75
I.E.E.E.	86
International Crystal Mfg. Co., Inc.	108
International Radio Exchange	85
Jerrold Electronics Corporation (Distributor Sales Division)	89
JFD Electronics Corp.	14-15
Mallory Distributor Products Company (Div. of P. R. Mallory & Co., Inc.)	23
McGraw-Hill Book Co.	17
Mike Quinn Electronics	93
Milwaukee School of Engineering	68
Music Associated	98
National Radio Institute	8-11
Olson Electronics, Inc.	102
Permoflux Corp.	93
Poly Paks	107
Quam Nichols Co.	87
Radar Devices	1
RCA Electronic Components and Devices Tubes	Fourth Cover
RCA Institutes, Inc.	28-31
RCA Parts and Accessories	69
RCA Sales Corporation	77
Reading Improvement Program	101
Rye Sound Corporation	95
S & A Electronics Inc.	83
Sams & Co., Inc., Howard W.	24, 73
Schober Organ Corp., Inc.	12
Scott, Inc., H.H.	85
Score	87
Shure Bros.	16
Solid State Sales	105
Sprague Products Company	67
Surplus Center	98
Sylvania (Subsidiary of General Telephone & Electronics)	13
TAB	102
United Radio Co.	104
Warren Electronic Components	106
Weller Electric Co.	96
Wen Products, Inc.	94
Wuerth Products Corp.	86
<b>MARKET CENTER</b>	104-107
Chemtronics	
Edmund Scientific Corp.	
Fair Radio Sales	
<b>SCHOOL DIRECTORY</b>	103
American Institute of Engineering & Technology	
American Technical Writing Schools	
Coyne Electronics Institute	
Grantham School of Electronics	
Industrial Training Institute	
Northrop College of Science & Engineering	
Tri-State College	
Valparaiso Technical Institute	



CABINET only for Hewlett Packard 150A scope. RCJ, 314 Moraga, San Francisco, Calif. 94122

TOY TRAINS BEFORE 1941. Trade Radios of 1920's. TED GENG, 28 Division St., New Brunswick, N. J. 08901

PROJECTION TELEVISION COMPONENTS WANTED. Need optic systems and projection tubes. State price and condition. J. KRIZSAN, 2519 Ashurst, Cleveland, Ohio 44118

## AUDIO - HI-FI

RENT STEREO TAPES—over 2,500 different—all major labels—free brochure. STEREO-PARTI, 1616-R Terrace Way, Santa Rosa, Calif. 95404

HI-FI COMPONENTS. Tape Recorders. at guaranteed "WE will not be undersold" prices. 15-day moneyback guarantee. Two-year warranty. NO Catalog. Quotations Free. HI-FIDELITY CENTER, 239R East 149th St., N.Y., N.Y. 10451

TAPE RECORDER SALE. Brand new, latest models. \$10.00 above cost. ARKAY SALES, 1028-E Commonwealth Ave., Boston, Mass. 02215

WRITE for highest discounts on components, recorders, tapes, from franchised distributors. Send for FREE monthly specials. CARSTON, 1686-R Second Ave. N.Y.C. 10028

STEREO TAPES. Save up to 60% (no membership fees, postpaid anywhere USA). Free 60-page catalog. We discount batteries, recorders, tape accessories—speakers—electronic parts. "not undersold." as the discount information you supply our competitor is usually reported to the factory. SAXITONE, 1776 Columbia Road, Washington, D. C. 20009

TAPEMATES makes available to you ALL 4-TRACK STEREO TAPES—ALL LABELS—postpaid to your door—at tremendous savings. For free brochure write TAPEMATES CLUB, 5727 W. Jefferson Blvd., Los Angeles, Calif. 90016

HI FI Equipment At Dealer. Wholesale Cost. Catalog. MACALESTER CORPORATION, 355 Macalester, Saint Paul, Minnesota 55105

McGEE RADIO COMPANY. Big 1966-1967 catalog sent free. America's best values, hi-fi—amplifiers—speakers—electronic parts. Send name, address and zip code number to McGEE RADIO COMPANY, 1901 McGee Street, Dept. RE, Kansas City, Missouri 64108

HI-FIDELITY COMPONENTS, Ham Marine and Communication equipment at considerable savings. If you want to save money write us for our low prices on all your needs. AIREX RADIO CORP., 132 (RE) Nassau St., New York, N.Y. 10038

FOR SALE: SHURE 315 figure-8 ribbon mike. List \$89.50. Barely used. 50-12,000 cps, variable impedance switch, 20 ft. cable. Highest quality. \$30. BURTON GLICK, 65-40 182nd St., Flushing, N.Y. 11365

## BUSINESS AIDS

JUST STARTING IN TV SERVICE? Write for FREE 32 PAGE CATALOG of Service Order books, invoices, job tickets, phone message books, statements and file systems. OELRICH PUBLICATIONS, 6556 W. Higgins, Chicago, Ill. 60656. New Hyde Park 5, N.Y.

1,000 Business Cards, "Raised Letters" \$3.95 postpaid. Samples. ROUTH, 5717 Friendswood, Greensboro, N. C. 27409

## BUSINESS OPPORTUNITIES

TRAIN for solid high paying career in electrical repair. Experimental kits included. Free fact pack. I.T.I., Dept. 65004, 815 E. Rosecrans, Los Angeles, Calif. 90059

INVENTIONS-IDEAS developed: Cash/Royalty sales. Member: UNITED STATES CHAMBER COMMERCE, Raymond Lee, 130-U W. 42nd, New York City 10036

INVENTIONS NEEDED! Free analysis. Dependable service. Experienced personnel. WALL STREET PROMOTIONS, INC., 99 Wall Street, New York, New York 10005

## ELECTRONICS

BARGAINS in Canadian Electronic equipment and surplus. Send \$1.00 for giant catalogs. ETCO, Dept. R, 520 Fifth Avenue, New York 36, N.Y.

PROFESSIONAL ELECTRONICS PROJECTS — \$1 up. Catalog 25¢. PARKS, Box 25565A, Seattle, Wash. 98125

TUBES. "Oldies", latest. Lists free. STEINMETZ, 7519 Maplewood, Hammond, Indiana 46324

## UNUSUAL BARGAINS

... MANY U.S. GOV'T SURPLUS

"Balls of Fun" for Kids . . . Traffic Stoppers for Stores . . . Terrific for Amateur Meteorologists . . .

### SURPLUS GIANT WEATHER BALLOONS



At last . . . available again in big 8-ft. diameter. Create a neighborhood sensation. Great backyard fun. Exciting beach attraction. Blow up with vacuum cleaners or auto air hose. Sturdy enough for hard play; all over uses. Filled with helium (available locally) use balloons high in the sky to attract crowds, advertise store sales, announce fair openings, etc. Amateur meteorologists use balloons to measure cloud heights, wind speed, humidity at various heights. Photographers can utilize for low-cost aerial photos. Recent Gov't surplus of heavy, black, neoprene rubber. Stock No. 60,568EH \$2.00 Ppd.

### BATTERIES GUARANTEED RECHARGEABLE FOR 5 YRS.



Use these remarkable space-age Nickel-Cadmium batteries in flashlights, portable radios, toy or flash guns. Obsolete all other! Low-cost kit includes compact, highly efficient battery charger and 2 "D" size Ni-Cd batteries guaranteed rechargeable to full power for 5 yrs. Power output remains constant — doesn't fade away as with lead-acid cells. Durable, black plastic charger 5 3/4" x 3" x 1 3/4" (dp. plugs into standard wall outlet. Completely charges 1 or 2 "D" or "C" size batteries in 16 hrs. Light shows when unit is charging — will not overcharge.

Stock No. 60,591EH \$9.95 Ppd.  
Stock No. 60,592EH (Charger only) \$5.98 Ppd.  
Stock No. 60,593EH (Two "D" Cells only) \$5.98 Ppd.

Order by Stock No. Check or M. O.—Money-Back Guarantee. EDMUND SCIENTIFIC CO., Barrington, N. J. 08007

### SEND FOR FREE CATALOG "EH"

Completely new 1967 edition. New items, categories, illustrations. Dozens of electrical and electromagnet parts, accessories. Enormous selection of Astronomical Telescopes, Microscopes, Binoculars, Magnifiers, Magnets, Lenses, Prisms. Many war surplus items: for hobbyists, experimenters, workshop, factory. Mail coupon for catalog "EH".



NAME .....

ADDRESS .....

CITY ..... STATE ..... ZIP .....

### CLIP AND MAIL COUPON TODAY

Circle 143 on reader's service card

## SPECIAL INTRODUCTORY OFFER

15 Epoxy Rectifiers With Every \$5.00 Purchase. Many Over 600 PIV. No Shorts or Opens.

### Silicon Power Rectifiers

PRV	3A	20A	40A
50			.75
100	.10	.40	1.00
200	.20	.60	1.50
400	.25	.80	2.00
600	.35	1.20	2.50
800	.45	1.50	3.00
1000	.65		3.50

### 5A Insul Base Top Hat & Epoxy 750 MA

PRV	7A	PRV	7A
100	.20	100	.07
200	.40	200	.09
400	.60	400	.12
600	1.00	600	.20
800	1.25	800	.25
1000	1.40	1000	.50
1200	1.60	1200	.65
		1400	.85

### Silicon Control Rectifiers

PRV	7A	PRV	7A
50	.35	300	1.35
100	.60	400	1.75
200	.90	500	2.25

Terms: FOB Cambridge, Mass. Send check or Money Order. Include Postage, Average Wt. per package 1/2 lb. Allow for C.O.D. Minimum Order \$2.00

### INTEGRATED CIRCUITS ARE NOW AVAILABLE.

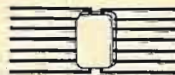

FLIP FLOPS \$1.50 GATES \$1.50

TO-85 Flat Pak. They come complete with a schematic, elect. characteristic sheet & some typical applications. The original manufacturer's price is several times ours.

"N" Channel FET'S SIM. to C-610 Used As Amp, Switch, Chopper—Very High Input Z Each \$1.50

SIM. to 2N1640 (PNP) Bi-directional transistors. A to-5 silicon unit in which collector & emitter are interchangeable. Ea. .... \$4.00

SIM. to 2N728. A high frequency to-18 unit extending to the UHF range ..... 5/\$1.00

GLASS DIODES color coded. Silicon ..... 20/\$1.00  
6E ..... 30/\$1.00

SIM. to 2N995 (PNP). Silicon in to-18 case. 500 MW power, to 180 MHz frequency .... 4/\$1.00

SIM. to 2N2875 (PNP). Silicon 20 watts with 30 MHz cut off 2/\$1.00

SIM. to 2N1648 (NPN) high voltage 40 Watt silicon unit, used in power output stages & power transistor drivers ... 2/\$1.00

SIM. to 2N255 (PNP), 20 watts in to-3 case ..... 4/\$1.00

10 WATT ZENERS. 2-70 volts. State desired voltages. Ea. \$.75

SILICON BILATERAL SWITCH. Replaces two SCR'S by firing in either direction when breakdown voltage is exceeded. Used in light dimmers, etc. .... 2/\$1.00

GaAs VARACTORS, sim. to AP-1, AP-6, etc. 70 GHz at 150 MW. Ea. .... \$4.00

4" x 10" SPEAKERS. 10 Ω. 1.5 oz Magnet. Ea. .... \$2.50

6" x 9" SPEAKERS. 20 Ω. 1.5 oz Magnet. Ea. .... \$2.50

4" SPEAKERS. 3.2 Ω. 1 oz Magnet. Ea. .... \$1.25

DUAL 1 MEG. POT. with off-on switch ..... 4/\$1.00

24 V 60 Hz 6 PDT 3 open, 3 closed 15 A Contacts ... \$4.00

455 KHz IF XRMRS ... 3/\$1.00

262 KHz IF XRMRS ... 3/\$1.00

DUAL 20 μF at 350 V Electrolytics ..... 3/\$1.00

28-101 P CERAMIC TRIMMERS ..... 6/\$1.00



POST OFFICE BOX 74 D  
SOMERVILLE, MASS. 02143

Name .....

Address .....

SEND FOR FREE CATALOG

City ..... State .....

Circle 144 on reader's service card



**SILICON RECTIFIER SALE**

IMMEDIATE DELIVERY



FULLY GTD AMERICAN MADE NEWEST TYPE FULLY TESTED

750 MA-SILICON "TOPHAT" DIODES  
LOW LEAKAGE FULL LEAD LENGTH

PIV/RMS 50/35 .05 ea.	PIV/RMS 100/70 .07 ea.	PIV/RMS 200/140 .10 ea.	PIV/RMS 300/210 .12 ea.
PIV/RMS 400/280 .14 ea.	PIV/RMS 500/350 .19 ea.	PIV/RMS 600/420 .21 ea.	PIV/RMS 700/490 .25 ea.
PIV/RMS 800/560 .30 ea.	PIV/RMS 900/630 .40 ea.	PIV/RMS 1000/700 .50 ea.	PIV/RMS 1100/770 .70 ea.

ALL TESTS AC & DC & FWD & LOAD  
SILICON POWER DIODE STUDS

D.C. AMPS	50 PIV 35 RMS	100 PIV 70 RMS	150 PIV 105 RMS	200 PIV 140 RMS
3	.08 ea.	.12 ea.	.16 ea.	.22 ea.
12	.25	.50	.85	1.75
35	.65	1.90	2.60	4.40
50	1.00	1.20	1.50	1.75
100	1.60	2.00	2.40	3.00

O.C. AMPS	300 PIV 210 RMS	400 PIV 280 RMS	500 PIV 350 RMS	600 PIV 400 RMS
3	.27 ea.	.29 ea.	.37 ea.	.45 ea.
12	1.90	1.20	1.40	1.65
35	2.00	2.35	2.60	3.10
50	2.20	3.25	3.50	4.00
100	3.60	4.50	5.25	7.00

"SCR" SILICON CONTROLLED RECTIFIERS "SCR"

PRV AMP	16 AMP	25 AMP	PRV AMP	16 AMP	25 AMP
25	.50	.75	1.00	.75	1.25
50	.80	1.25	1.50	1.40	2.15
100	1.50	2.00	2.50	2.40	3.80
150	.90	1.80	2.25	3.20	3.80
200	1.25	1.80	2.25	4.00	4.50

SPECIALS! SPECIALS!

Westinghouse 160 AMP, 500 PIV SILICON HI-POWER STUD RECTIFIER IN1666.  
Limited quantity. \$5.10 ea. 10 for \$45.00

100 Different Precision Resistors  
1/2—1—2 Watt 1/2%—1% TOL \$1.25  
Asst transistor kit. P.N.P.—N.P.N.  
All popular types. Unchecked  
100 for \$2.95 500 for \$9.95

Computer Grade Condenser 15,500 MFD  
12 VDC American Mfg. .75 ea.  
Type IN34 DIODE GLASS .07 ea 100 for \$5

Money Back guarantee. \$2.00 min. order. Include additional \$ for postage. Send check or money order. C.O.D. orders 25% down.

Warren Electronic Components  
230 Mercer St., N. Y., N. Y. 10012 • 212 OR 3-2620

Circle 145 on reader's service card

# MARKET CENTER

JAPAN & HONG KONG Electronics Directory. Products, components, supplies. 50 firms—just \$1.00. IPPANO KAISHA LTD., Box 6266, Spokane, Washington 99207

SURPLUS SEMICONDUCTORS and miniature electronic parts. Send 25¢ for catalog. ECD COMPANY, P.O. Box 1432, Plainfield, N. J. 07061

TV CAMERA KITS for experimenters and industry. Expanded line includes monitors, vidicons, lenses, tripods, slow scan, etc. NEW 1967 catalog, 10¢. ATV RESEARCH, Box 396-R, So. Sioux City, Nebr. 68776

FREE Catalog. Electronic parts, tubes. Wholesale. Thousands of items. Unbeatable prices. ARCTURUS ELECTRONICS RE, 502-22 St., Union City, N. J. 07087

COMPLETE TUNER SERVICE—\$8.95. Send tuner, or write for free mailing kit to MIDWEST TUNER REPAIR, Box 892C, Bloomington, Ind. 47401

BEFORE You Buy Receiving Tubes, Transistors, Diodes, Electronic Components & Accessories . . . send for Giant Free Zalytron Current Catalog, featuring all STANDARD BRAND TUBES all Brand New Premium Individually Boxed. One Year Guarantee—all at BIGGEST DISCOUNTS in America! We serve professional servicemen, hobbyists, experimenters, engineers, technicians. WHY PAY MORE? ZALYTRON TUBE CORP., 469R Jericho Turnpike, Mineola, N.Y. 11502

TV CAMERAS, converters, etc. Lowest factory prices. Catalog 10¢. VANGUARD, 196-23 Jamaica Ave., Hollis, N.Y. 11423

FREE CATALOG—Loads of electronic bargains. R.W. ELECTRONICS, INC., 2244 So. Michigan Ave., Chicago, Illinois 60616

"JAPANESE ELECTRONICS INDUSTRY" Monthly English Magazine. Sample \$1—Subscription \$10. DEE, 10639 Riverside, North Hollywood, Calif. 91602

**SOLDERING IRON**  
FAST HEAT 80 WATT  
Complete with quality line cord. \$149  
No limit from this list.  
6AG5 6SN7  
6AQ5 6CB6 6S4  
6AU6 6J6 6W4

Prestige & Success are yours  
as an **ELECTRONIC EXPERT**  
FOR CORNELL CUSTOMERS ONLY by special arrangement with the publisher, these amazing bargains are available.  
COMPLETE RADIO SERVICING AND BASIC ELECTRONICS COURSE ONLY \$3.00  
NEW PRACTICAL TV TRAINING COURSE ONLY \$3.50  
Both above courses \$6.00

NEW EASY TO USE!  
**RADIO-TV TUBE TESTER**  
TEST and REPAIR TV & RADIO SETS, APPLIANCES.  
\$2.89 plus 30¢ shipping

**CORNELL**  
**33¢** PER TUBE  
100 TUBES OR MORE: **30¢ PER TUBE**

**TUBES**  
1 YR. GUARANTEED  
Mutual Conductance Lab-tested, Individually Boxed, Branded and Code Dated. Tubes are new, or used and so marked.

OZ4	6A55	6CB6	6K6	6X4	12BF6
1B3	6AT6	6CF6	6K7	6X8	12BH7
1J3/1K3	6AT8	6CG7	6Q7	7A7	12BL6
1H5	6AU4	6CG8	6S4	7AB	12BY7
1L4	6AU5	6CM7	6SA7	7B6	12C5
1T4	6AU6				12CA5
1U4	6AV6				12SN7
1X2	6AW8				12SQ7
3BZ6	6AX4				25L6
3DG4	6BA6				25Z6
5U4	6BC5				35W4
5U8	6BD6	6CZ5	6SH7	7C5	35Z3
5V4	6BG6	6D6	6SJ7	7N7	50L6
5Y3	6BJ6	6DA4	6SK7	7Y4	24
6A6	6BL7	6DE6	6SL7	12AD6	27
6AB8	6BN4	6DQ6	6SN7	12AE6	77
6AC7	6BN6	6EA7	6SQ7	12AF6	78
6AG5	6BQ6	6EM5	6SR7	12AT7	84/6Z4
6AK5	6BQ7	6F6	6U7	12AU7	5687
6AL5	6BZ6	6GH8	6U8	12AX7	6350
6AN8	6C4	6H6	6V6	12BA6	6463
6AQ5	6C6	6J5	6W4	12BD6	7044
	6CB6	6J6	6W6	12BE6	

Other tubes at low prices—send for free list

**21 PICTURE TUBES**  
1 yr. Guaranteed  
No C.O.D. on Picture Tubes

17AVP4	17ACP4	17DLP4
17AP4	17AP4	17DP4
17BM4	17BM4	17CP4
17CP4	17AP4	17DP4
17CP4	17AP4	17DP4
17CP4	17AP4	17DP4
17CP4	17AP4	17DP4
17CP4	17AP4	17DP4
17CP4	17AP4	17DP4

all purpose **ELECTRONIC CLEANER**  
89¢ plus shipping

**SILICON RECTIFIERS**  
750 MA 400 PIV 69¢ Per Pair  
1000 MA 800 PIV 89¢ Per Pair

**DIODES/RECTIFIERS**  
39¢ per pair plus shipping  
sensational **KIT VALUE**

**DIODES/RECTIFIERS**  
39¢ per pair plus shipping  
sensational **KIT VALUE**

**EPOXY DIODES**  
800 PIV 79¢ Per Pair  
1000 MA EACH REVIDE

**EPOXY DIODES**  
800 PIV 79¢ Per Pair  
1000 MA EACH REVIDE

**TUBE CARTONS**  
HIGH GLOSS CLAY COATED RED & BLACK WITH BUILT IN DIAGONAL PARTITIONS.

YR. TUBE SIZE	PRICE PER 100 CARTONS	PRICE PER 100 TUBES
1/2" DIA.	.29	2.59
5/8" DIA.	.39	3.49
1" DIA.	.59	5.29
1 1/2" DIA.	.89	7.99

**TV INTERFERENCE TRAPPER**  
\$1.59

**PICTURE EXPANDER**  
99¢

**GIANT TWIN-PACK SELF STICKING PLASTIC ELECTRICAL TAPE**  
12,000 VOLT INSULATION  
89¢

**CAR RADIO POWER TRANSISTORS**  
No. 05501 99¢  
No. 2N301A 69¢

**CORNELL ELECTRONICS CO.**  
Dept RE1 4217 University Ave., San Diego, Calif. 9 2 1 0 5

TERMS: Add 3c per tube shipping. Orders under \$5.00 add 3c per tube shipping plus 50c handling. Canadian orders add approximate postage. Send 25¢ deposit on C.O.D. orders. No C.O.D. orders under \$5.00 or to Canada. No 24 hr. free offer on personal check orders. 5-DAY MONEY BACK OFFER.

Circle 146 on reader's service card



TELEPHONE RECORDER-ACTUATOR (TWI-007). Solid state module automatically turns tape recorder, amplifier, or transmitter on when telephone in use. Connected anywhere on line. Simple installation instructions included. Pre-paid \$18.95. TWILIGHT ELECTRONICS, Box 11595-R, St. Louis, Mo. 63105

RADIO & TV TUBES 33¢ each. One year guaranteed. Plus many unusual electronic bargains. Free catalog. CORNELL, 4217-E University, San Diego, California 92105

TRANSISTORS-DIODES — Components. Large selection. Write for FREE catalogue. ELECTRONIC COMPONENTS CO. Box 2902B, Baton Rouge, La. 70821

EXPERIMENTER'S GIANT catalog 250 exclusive items—25¢, refundable. LABORATORIES, 12041-B Sheridan, Garden Grove, Calif. 92640

## GOVERNMENT SURPLUS

72 page illustrated Government Surplus Radio, Gadgets Catalog 25¢. MESHNA, Nahant, Mass.

## EDUCATION/ INSTRUCTION

LEARN ELECTRONIC ORGAN SERVICING. New home study course covering all makes electronic organ including transistors. Experimental kits—schematics—trouble-shooting. Accredited NHSC-GI Approved. Write for free booklet. NILES BRYANT SCHOOL, 3631 Stockton Blvd., Dept. F, Sacramento 20, Calif.

FCC LICENSE in 6 weeks. First Class Radio Telephone. Results Guaranteed. ELKINS RADIO SCHOOL, 2603E Inwood, Dallas, Tex.

SLEEP LEARNING. Hypnotism! Tapes, records, books, equipment. Details, strange catalog FREE. RESEARCH ASSOCIATION, Box 24-RD, Olympia, Wash.

BROADCASTING. Communications Electronics taught quickly—resident classes; correspondence. Free details. Write: Dept. 4, GRANTHAM SCHOOLS, 1505 N. Western, Hollywood, Calif. 90027

REI First Class Radio Telephone License in (5) weeks Guaranteed. Tuition \$295.00. Job placement free. RADIO ENGINEERING INSTITUTE, 1336 Main Street, Sarasota, Fla.

CORRESPONDENCE COURSES—B.Sc., Engineering, Electronics, Catalog \$1. CANADIAN INSTITUTE OF SCIENCE & TECHNOLOGY, 263E Adelaide St. W., Toronto

LEARN TECHNICAL WRITING—qualify at home for high paying prestige career not requiring college. Growing demand in all industries for tech writers now. Low monthly tuition. Easy to understand. FREE career book, sample lesson. AMERICAN TECHNICAL WRITING SCHOOLS, Dept. REC-17, 5512 Hollywood Blvd., Hollywood, Calif. 90028

WATCH REPAIRING. Swiss and American watches. Develop skill step by step in spare time at home. Diploma awarded. Free sample lesson. CHICAGO SCHOOL, Dept. REA, Fox River Grove, Ill. 60021

CLASSIFIED COMMERCIAL RATE (for firms or individuals offering commercial products or services): 60¢ per word . . . minimum 10 words.

NON-COMMERCIAL RATE (for individuals who want to buy or sell personal items): 30¢ per word . . . no minimum.

Payment must accompany all ads except those placed by accredited advertising agencies. 10% discount on 12 consecutive insertions, if paid in advance. Misleading or objectionable ads not accepted. Copy for February issue must reach us before December 9th.

WORD COUNT: Include name and address. Name of city (Des Moines) or state (New York) counts as one word each. Zone or Zip Code numbers not counted. (We reserve the right to omit Zip Code if space does not permit.) Count each abbreviation, initial, single figure or group of figures or letters as a word. Symbols or groups such as 8-10, COD, AC, etc., count as one word. Hyphenated words count as two words. Minor over-wordage will be edited to match advance payment.

# SPECIAL For OFFER 1967 FREE!

With Every \$5.00 Purchase,  
CHOOSE ANY \$1 ITEM FREE

FOR OUR BARGAIN CATALOG  
ON:  Semiconductors  
 Poly Paks  Parts

World's "BEST BUYS"



MADE IN U.S.A. **0-50**  
D.C. MICROAMMETERS  
IDEAL FOR 2" 5 METER. **\$2.88**  
• SOLAR CELL  
• Geiger Counter

1 AMP 800 PIV SUBMINIATURE RECTIFIERS **4 for \$1**

**"N" Channel Fet's Similar \$1.29 To C-610**

**SILICON CONTROL RECTIFIERS**

PRV	1 AMP	3* AMP	PRV	1 AMP	3 AMP
25	35¢	—	200	81¢	95¢
50	45¢	45¢	400	1.25	1.50
100	61¢	69¢	*TO-9, w/3 leads N Stud		
150	69¢	81¢			

**WORLD'S MOST POPULAR \$1 PARTS PAKS**

3 INFRA-RED DETECTORS, with leads .....\$1  
 \$25 SURPRISE PAK: transistors, rect, diodes, etc. \$1  
 40 PRECISION RESISTORS, 1/2, 1, 2W; 1% values \$1  
 30 CORNING "LOW NOISE" resistors, 5% too! \$1  
 60 TUBULAR CONDENSERS, to .5mf, to 1kv, asst \$1  
 40 DISC CONDENSERS, 27 mmf to .05 mf to 1KV \$1  
 60 TUBE SOCKETS, receptacles, plugs, audio, etc. \$1  
 30 POWER RESISTORS, 5 to 50W, to 24K ohms .....\$1  
 30 MICA CONDENSERS, to .1mf, silvers too! .....\$1  
 10 VOLUME CONTROLS, to 1 meg, switch too! .....\$1  
 10 ELECTROLYTICS, to 500mf, asst FP & tubulars \$1  
 50 RADIO & TV KNOBS, asst, colors & styles .....\$1  
 10 TRANSISTOR ELECTROLYTICS: 10 mf to 500 mf \$1  
 50 COILS & CHOKES, if, rf, ant, osc, & more .....\$1

**FACTORY TESTED SEMI-KON-DUCTORS**

3 2N706 500MW, 300MC NPN PLANAR, TO-18 ....\$1  
 4 2N35 TRANSISTORS, npn, by Sylvania, TO22 ..\$1  
 4 2N255 POWER TRANSISTOR EQUALS, TO3 case \$1  
 2—500 MC, 2N708 NPN SILICON planar TO46 ....\$1  
 15 NPN TRANSISTORS, 2N35, 170, 440, no test ..\$1  
 85 WATT 2N424 PLANAR, silicon, TO-53 npn.....\$1  
 10 NPN SWITCHING TRANSISTORS, 2N338, 440 ....\$1  
 25 ZENERS GLASS SILICON DIODES, no test .....\$1  
 2 "TINY" 2N1613 2W, 100MC, TO46 case, npn \$1  
 15 PNP TRANSISTORS, CK722, 2N35, 107, no test \$1  
 4 BIDIRECTIONAL TRANSISTORS, 2N1641 types ..\$1  
 3 2N711 300MW, 300 MC, PNP MESA, TO18 .....\$1

**1 WATT ZENER DIODES**

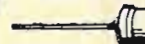
 **3 For \$1**

Volts	Volts	Volts	Volts	Volts	Volts	Volts	Volts
10	15	22	33	47	68	100	150
11	16	24	36	51	75	110	160
12	18	27	39	56	82	120	180
13	20	30	43	62	91	130	200

**2-Amps "GLASSMIKE" SILICON RECTIFIERS**

PIV Sale PIV Sale  
 50 9¢ 600 40¢  
 100 13¢ 800 51¢  
 200 19¢ 1000 69¢  
 400 29¢

**HIGH POWER \$1**

PNP 100Watt/15 Amp HiPower  
 TO36 Case! 2N441, 442, 277,  
 278, DS501 up to 50' Volts  
 2N1100 BV<sub>CEO</sub> 100 \$1.96

**SILICON POWER STUD RECTIFIERS**

AMPS	25 PIV	50 PIV	100 PIV	200 PIV
3	—	5¢	9¢	19¢
15	—	22¢	40¢	65¢
35	—	50¢	75¢	1.19

**35 TWO WATERS, asst incl: A.B., 5% too! .....\$1**  
 75 HALF WATERS, asst incl: A.B., 5% too! ....\$1  
 60 HI-Q RESISTORS, 1/2, 1, 2W, 1% & 5% values \$1  
 10 PHONO PLUG & JACK SETS, tuners, amps .....\$1  
 10 TUBULAR ELECTROLYTICS, to 500 mf .....\$1  
 INFRA-RED PHOTO DETECTOR TRANSDUCER .....\$1  
 INFRA-RED PARABOLIC REFLECTOR & FILTER .....\$1  
 40 WORLD'S SMALLEST COND., to .05mf .....\$1  
 4 TRANSISTOR TRANSFORMERS, asst, worth \$25 \$1  
 2 CLAIREX PHOTO ELECTRIC CELL, CL607 .....\$1  
 60 CERAMIC CONDENSERS, diss, npo's, to .05 ..\$1  
 40 "TINY" RESISTORS, 1/10W, 5% too! .....\$1  
 10 TRANSISTOR SOCKETS for pnp-npn transistors \$1  
 30 MOLDED COND'S, mylar, pore, black beauty \$1

**750 MIL TOP HAT AND EPOXIES**

PIV	Sale	PIV	Sale	PIV	Sale
50	5¢	600	19¢	1400	75¢
100	7¢	800	24¢	1600	95¢
200	9¢	1000	40¢		
400	11¢	1200	59¢		

**POLY PAKS**

TERMS: Send check, money order.  
 Add postage—avk. wt. per pak 1 lb. Rated net 30 days. COD 25 %

P.O. BOX 942 R  
 SO. LYNNFIELD, MASS.  
 "PAK-KING" of the world

30 TRANSISTORS, rf, lf, audio osc-ifs, TO5 no test \$1  
 3 2-WATT PLANAR TRANS'TRS, 2N697, 100mcnpn \$1  
 4 2N33 6 NPN SILICON transistors, Transistron \$1  
 10 ZENERS REFERENCES stud, asst types .....\$1  
 25 GERMANIUM & SILICON DIODES, no test .....\$1  
 25 TOP HAT RECTIFIERS, silicon, 750ma, no test \$1  
 10 FAMOUS CK722 TRANSISTORS, npn no test ....\$1  
 10 30-MC TRANSISTORS, silicon, TO18, no test \$1  
 3—2N705 MESA, 300 mc, 300 mw, npn, TO18...\$1  
 10 2-6AMP RECT's, studs, silicon, 50 to 400 V ....\$1  
 10 PNP SWITCHING TRANSISTORS. 2N404, no test \$1

Circle 147 on reader's service card

JANUARY 1967

107



# INTERNATIONAL FREQUENCY METERS

*designed for servicing!*

Equip your lab or service bench with the finest



## FM-5000 FREQUENCY METER 25 MC to 470 MC

The FM-5000 is a beat frequency measuring device incorporating a transistor counter circuit, low RF output for receiver checking, transmitter keying circuit, audio oscillator, self contained batteries, plug-in oscillators with heating circuits covering frequencies from 100 kc to 60 mc. Stability:  $\pm .00025\%$   $+85^\circ$  to  $+95^\circ\text{F}$ ,  $\pm .0005\%$   $+50^\circ$  to  $+100^\circ\text{F}$ ,  $\pm .001\%$   $+32^\circ$  to  $+120^\circ\text{F}$ . A separate oscillator (FO-2410) housing 24 crystals and a heater circuit is available. Shipping weight: 18 lbs.

FM-5000 with batteries, accessories, less oscillators and crystals.  
Cat. No. 620-103.....\$375.00

Plug-in oscillators with crystals \$20.00 to \$50.00



## C-12M FREQUENCY METER For Marine Band Servicing

The C-12M is a portable secondary standard for servicing radio transmitters and receivers in the 2 mc to 15 mc range. The meter has sockets for 24 crystals. Frequency stability is  $\pm .0025\%$   $32^\circ$  to  $125^\circ\text{F}$ ,  $\pm .0015\%$   $50^\circ$  to  $100^\circ\text{F}$ . The C-12M has a built-in transistorized frequency counter circuit, AM percentage modulation checker and relative percentage field strength. Shipping wt. 9 lbs.

C-12M with PK (pick-off) box and connecting cable, batteries, but less crystals.  
Cat. No. 620-104.....\$235.00

Crystals for C-12M (specify frequency)  
\$7.00 to \$10.00



## Model 7212 FREQUENCY METER

The International Model 7212 portable secondary frequency standard is a self contained unit designed for servicing radio transmitters and receivers used in the 400 kc to 500 kc range (can be modified for other frequencies on special order). Frequency accuracy is  $\pm .01\%$  from  $32^\circ\text{F}$  to  $104^\circ\text{F}$  ( $0^\circ\text{C}$  to  $40^\circ\text{C}$ ). The meter holds eight crystals. Features include the transistorized frequency oscillator and built-in battery charger. Shipping weight: 18 lbs.

Model 7212 complete with crystals.  
Cat. No. 620-105.....\$575.00



## CRYSTAL CONTROLLED C-12 ALIGNMENT OSCILLATOR

The International C-12 alignment oscillator provides a standard for alignment of IF and RF circuits 200 kc to 60 mc. It makes the 12 most used frequencies instantly available through 12 crystal positions 200 kc to 15,000 kc. Special oscillators are available for use at the higher frequencies to 60 mc. Maximum output .6 volt. Power requirements: 115 vac. Shipping wt. 9 lbs.

C-12 complete, but less crystals.  
Cat. No. 620-100.....\$ 69.50

Write today for our  
**FREE CATALOG**

Circle 148 on reader's service card



## Model 1110 SECONDARY FREQUENCY STANDARD

The Model 1110 is an economy portable secondary standard for field or bench use with self contained battery. Using any general coverage communications receiver the unit provides the necessary standard signal for measuring frequencies. Easily calibrated against WWV to provide an accuracy of  $1 \times 10^6$ . Long term stability of  $\pm 10$  cycles over range  $40^\circ\text{F}$  to  $100^\circ\text{F}$ . All transistor circuits provide outputs at 1 mc, 100 kc and 10 kc. Zero adjustment for oscillator on front panel. SHIPPING WEIGHT — 12 lbs.

Model 1110 complete.  
Cat. No. 620-106.....\$125.00

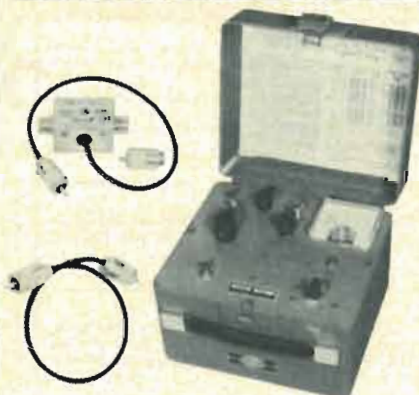

## C-12B FREQUENCY METER For Citizens Band Servicing

This extremely portable secondary frequency standard is a self contained unit for servicing radio transmitters and receivers used in the 27 mc Citizens Band. The meter is capable of holding 24 crystals and comes with 23 crystals installed. The 23 crystals cover Channel 1 through 23. The frequency stability of the C-12B is  $\pm .0025\%$   $32^\circ$  to  $125^\circ\text{F}$ ,  $.0015\%$   $50^\circ$  to  $100^\circ\text{F}$ . Other features include a transistorized frequency counter circuit, AM percentage modulation checker and power output meter. Shipping weight: 9 lbs.

C-12B with -PK (pick-off) box, dummy load, connecting cable, crystals, batteries.  
Cat. No. 620-101.....\$300.00

KEEPING YOU ON FREQUENCY IS OUR BUSINESS . . .



INTERNATIONAL  
CRYSTAL MFG. CO., INC.  
18 NO. LEE • OKLA. CITY, OKLA. 73102

RADIO-ELECTRONICS



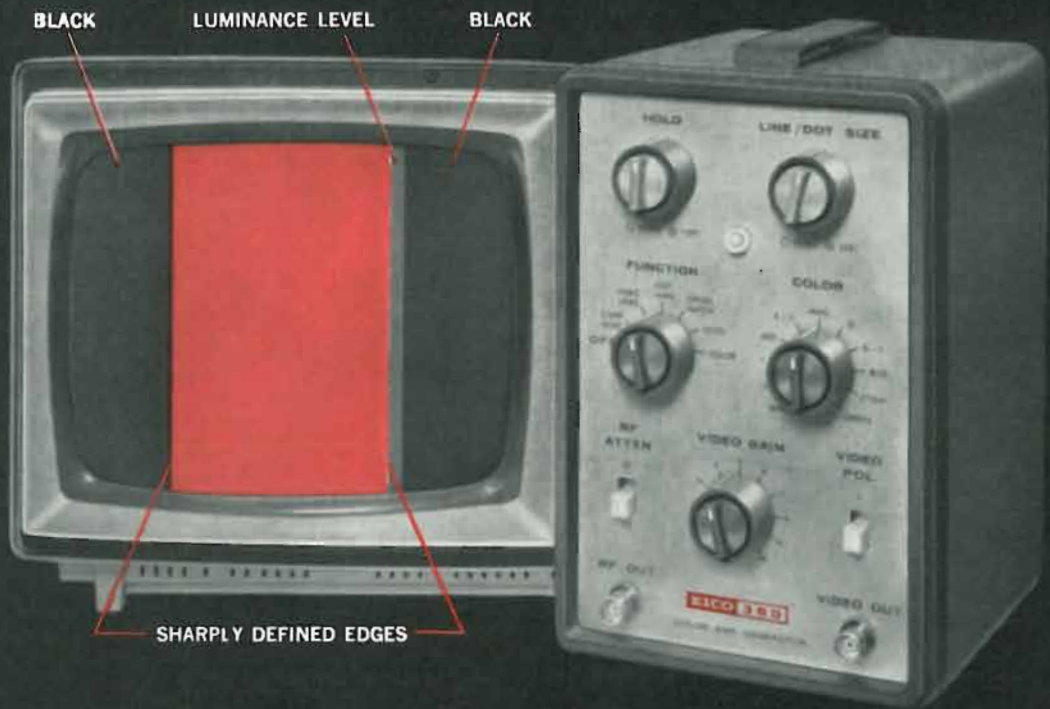

EICO 380's color signals (3 primaries, 3 complementaries) cover fully 60% of the screen: thus tell you MORE about the set's response — enable EXACT alignment.

# Now you can afford a True NTSC\* Color Generator

(NEW EICO ALL SOLID STATE 380 IS ONLY \$169.)

## Every pro knows

that the best generator to use to do the *best, fastest, most accurate* color servicing is the NTSC type. EICO is first to bring it to you at a serviceman price.

The 380 takes the risky guesswork out of color servicing — because it gives you all test signals *exactly* like the Color TV station. So now you can be *certain* of exact results — faster, easier, for more profits per day. You'll also quickly become known as the pro who makes sets "*come alive*" with brilliant correct color response!

Only EICO provides you with all these advanced engineering features at so low a cost: ■ **100% true NTSC\* full-field color signals**, including both chrominance and luminance exactly as specified for a Color TV station transmission. ■ **No "Gun Killers"** — Faster, easier use by feeding to the RF stage. You don't need to go inside the TV set to feed the color signal. ■ **Each true NTSC\* color signal covers fully 60% of the entire TV screen** (as compared to 1-inch from a rainbow generator) — this tells you a full, true picture of what's going on inside the set — all the way from the RF to the screen. ■ **100% solid state** (33 transistors). ■ **5 individual switch-selected alignment patterns** for monochrome and color. ■ **Individual, switch-selected full-field color display**. ■ **Generates I, Q, R-Y, and B-Y signals** for demodulator adjustment, plus 7 standard color signals (3 primaries, 3 complementaries, plus black and white). ■ **Adjustable bar width and dot size** down to just visible for exact convergence. ■ **3 crystal-controlled oscillators** for true 3.58 MC color signal generation, pattern timing, and RF output. ■ **Drift-free RF output** (crystal-controlled Channel 3) and video output. ■ **Conveniently compact**: 8" high x 5" wide x 6" long. ■ **Portable and light weight** (only 4 lbs.) for easier field use. ■ **Instant-on operation**: time-saving, accurate, drift-free. ■ **Excellent for field or shop**. And **will not become obsolete!**

Why buy an old-fashioned semi-accurate non-NTSC rainbow generator when you can get all the extra benefits of a 100% TRUE NTSC COLOR GENERATOR for the same money.

See your EICO dealer today for a free demonstration.

## Unbeatable Value COMPLETE COLOR/BW TV LAB

With the 380 — plus just the 369 & 435 — you're ready for *anything* in Color/BW servicing: EICO 369 Sweep/Marker Generator gives easiest, fastest visual alignment of color or B&W TV and FM RF and IF circuits. Five sweep ranges from 3-220mc. Four marker ranges from 2-225 mc. Crystal marker oscillator. Post injection of markers. **\$99.95 kit, \$149.95 wired.**

EICO 435 Direct-Coupled Wideband Scope. DC-4.5mc with 3" flat-face CRT. Zener calibrator. Outperforms 5" scopes three times its price. **\$109.95 kit, \$159.95 wired.**

## How about FM-MX Stereo?

Just add EICO 342 FM-MX Signal Generator: Gives both composite audio and FM RF outputs. Inputs for stereo audio, critical A/B tests. **\$149.95 wired.**

*\*The NTSC (National Television Systems Committee) color signal is based on the fact that each transmitted color is produced by an NTSC-defined relationship between a 3.58 MC reference and a 3.58 MC chroma modulated subcarrier, with each color having a standard NTSC brightness component. This is the basis upon which all color-TV broadcasters must operate. There are no separate rules for color-TV reception, or color test sets.*



EICO Electronic Instrument Co., Inc.  
131-01 39th Ave., Flushing, N.Y. 11352

RE-1

Send me FREE:

- "Definitive Comparison of NTSC and rainbow generators FROM THE SERVICEMAN'S VIEWPOINT."
- 32-page catalog on 200 EICO best buys.
- Name of nearest dealer.

NAME.....  
ADDRESS.....  
CITY.....STATE.....ZIP.....

Circle 149 on reader's service card



Are you ready for *today's color?*

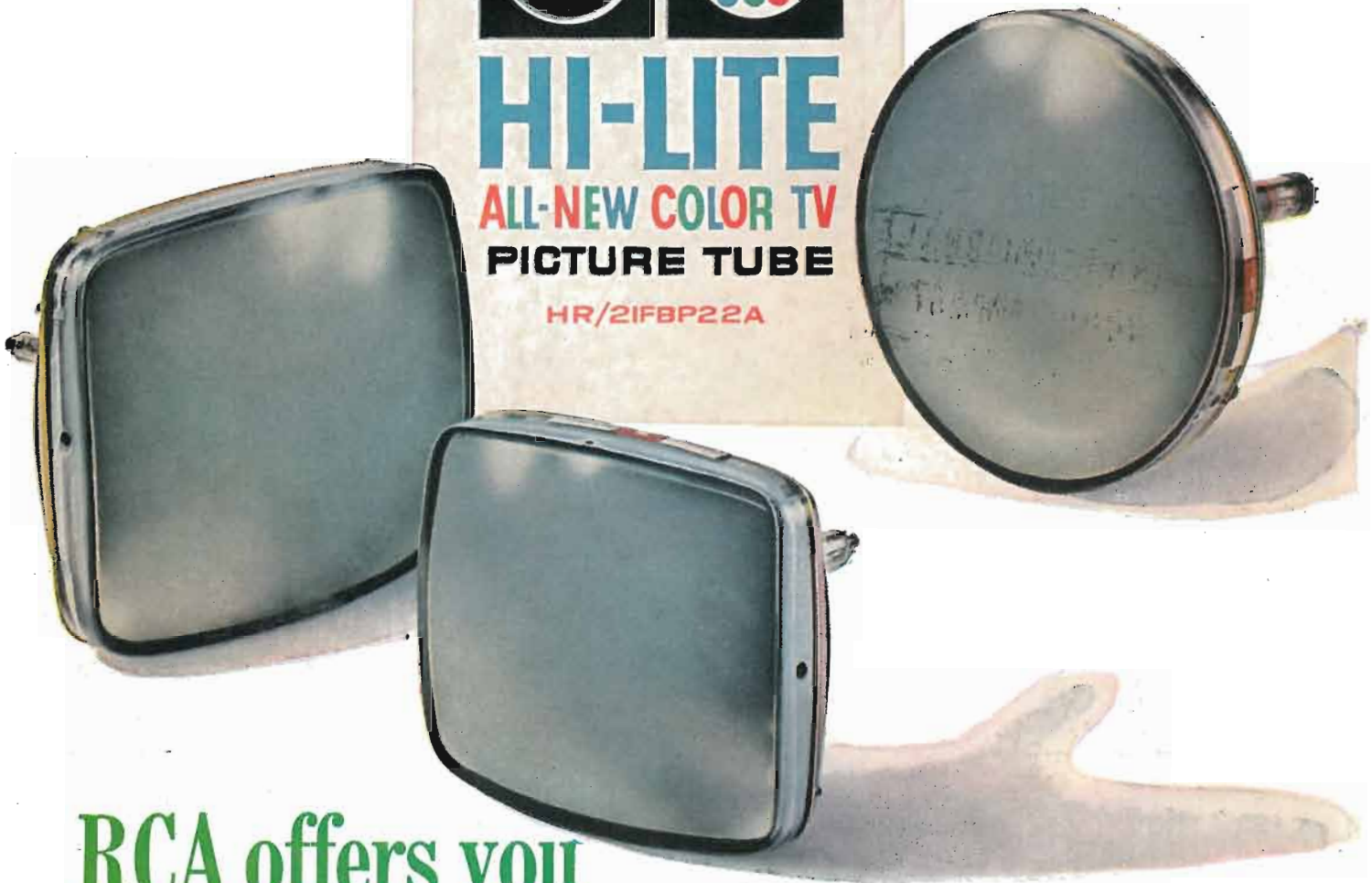

# RCA offers you a replacement color picture tube that meets OEM specs

RCA Hi-Lite picture tubes are all-new... glass, gun, the works! They're RCA's best... the same quality... the same tubes... that go into original equipment sets. And because they incorporate the latest technological advances of the world's largest color picture tube manufacturer, you literally "up-date" your customer's color set each time you install one. Here is picture brightness and color fidelity at its finest, available for the service trade in 19-inch and 25-inch rectangular and 21-inch round tube types.



RCA Electronic Components and Devices, Harrison, N.J.

**The Most Trusted Name in Electronics**